

SPACE-4 MK2 LASER

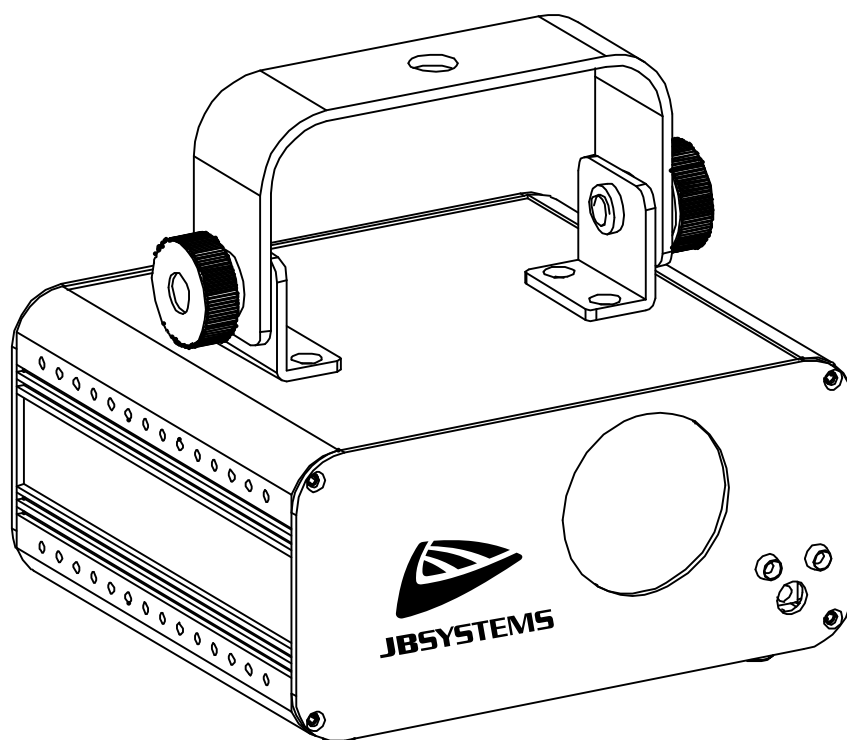

ENGLISH Operation Manual

Other languages can be downloaded from:
WWW.JB-SYSTEMS.EU



Version: 1.0

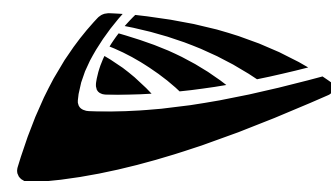

JB SYSTEMS



EN - DISPOSAL OF THE DEVICE

Dispose of the unit and used batteries in an environment friendly manner according to your country regulations.

FR - DÉCLASSER L'APPAREIL

Débarrassez-vous de l'appareil et des piles usagées de manière écologique Conformément aux dispositions légales de votre pays.

NL - VERWIJDEREN VAN HET APPARAAT

Verwijder het toestel en de gebruikte batterijen op een milieuvriendelijke manier conform de in uw land geldende voorschriften.

DU - ENTSORGUNG DES GERÄTS

Entsorgen Sie das Gerät und die Batterien auf umweltfreundliche Art und Weise gemäß den Vorschriften Ihres Landes.

ES - DESHACERSE DEL APARATO

Reciclar el aparato y pilas usadas de forma ecologica conforme a las disposiciones legales de su país.

PT - COMO DESFAZER-SE DA UNIDADE

Tente reciclar a unidade e as pilhas usadas respeitando o ambiente e em conformidade com as normas vigentes no seu país.

OPERATION MANUAL

Thank you for buying this JB Systems® product. To take full advantage of all possibilities and for your own safety, please read these operating instructions very carefully before you start using this unit.

FEATURES

This unit is radio-interference suppressed. This product meets the requirements of the current European and national guidelines. Conformity has been established and the relevant statements and documents have been deposited by the manufacturer.

- This device was designed to produce decorative effect lighting and is used in light show systems.
- A compact but very effective 50mW (515nm) green class 3B laser.
- Fabulous preprogrammed laser shows for all kinds of applications: lounge bar, discotheque, mobile DJ, ...
- Several working modes:
 - DMX-control: 1 channel for easy operation or 8 channels for full control.
 - Standalone: sound activated (internal mic) or automatic.
 - IR-remote: infrared remote control.
 - Master/slave: wonderful synchronized shows.
- Built-in microphone
- 3-digit LED display for easy menu navigation
- Key actuated on/off switch and emergency switch (interlock) input for additional safety
- Complies to EN/IEC 60825-1:2014 for Laser Safety

BEFORE USE

- Before you start using this unit, please check if there's no transportation damage. Should there be any, do not use the device and consult your dealer first.
- **Important:** This device left our factory in perfect condition and well packaged. It is absolutely necessary for the user to strictly follow the safety instructions and warnings in this user manual. Any damage caused by mishandling is not subject to warranty. The dealer will not accept responsibility for any resulting defects or problems caused by disregarding this user manual.
- Keep this booklet in a safe place for future consultation. If you sell the fixture, be sure to add this user manual.

Check the contents:

Check that the cardboard box contains the following items:

- SPACE-4 Mk2 LASER
- IR remote control
- 2 keys (for key switch)
- Spare connector for emergency stop
- Mains cable
- Operating instructions

SAFETY INSTRUCTIONS:



CAUTION
RISK OF ELECTRIC SHOCK
DO NOT OPEN



CAUTION: To reduce the risk of electric shock, do not remove the top cover. No user-serviceable parts inside. Refer servicing to qualified service personnel only.



The lightning flash with arrowhead symbol within the equilateral triangle is intended to alert the user or the presence of un-insulated "dangerous voltage" within the product's enclosure that may be of sufficient magnitude to constitute a risk of electric shock.



The exclamation point within the equilateral triangle is intended to alert the user to the presence of important operation and maintenance (servicing) instructions in the literature accompanying this appliance.



This symbol means: indoor use only



This symbol means: Read instructions



This symbol determines: the minimum distance from lighted objects. The minimum distance between light-output and the illuminated surface must be more than 1 meters



The device is not suitable for direct mounting on normally flammable surfaces. (suitable only for mounting on non-combustible surfaces)

RISK GROUP 2
CAUTION:
Do not stare at operating lamp

CAUTION: Do not stare at operating lamp.
May be harmful to the eyes.

- To protect the environment, please try to recycle the packing material as much as possible.
- To prevent fire or shock hazard, do not expose this appliance to rain or moisture.
- To avoid condensation to be formed inside, allow the unit to adapt to the surrounding temperatures when bringing it into a warm room after transport. Condense sometimes prevents the unit from working at full performance or may even cause damages.
- This unit is for indoor use only.
- Don't place metal objects or spill liquid inside the unit. Electric shock or malfunction may result. If a foreign object enters the unit, immediately disconnect the mains power.
- Locate the fixture in a well ventilated spot, away from any flammable materials and/or liquids. The fixture must be fixed at least 50cm from surrounding walls.
- Don't cover any ventilation openings as this may result in overheating.
- Prevent use in dusty environments and clean the unit regularly.
- Keep the unit away from children.
- Inexperienced persons should not operate this device.
- Maximum safe ambient temperature is 40°C. Don't use this unit at higher ambient temperatures.
- Make sure the area below the installation place is free from unwanted persons during rigging, de-rigging and servicing.
- Allow the device about 10 minutes to cool down before to start servicing.
- Always unplug the unit when it is not used for a longer time or before to start servicing.
- The electrical installation should be carried out by qualified personal only, according to the regulations for electrical and mechanical safety in your country.
- Check that the available voltage is not higher than the one stated on the unit.
- The power cord should always be in perfect condition. Switch the unit immediately off when the power cord is squashed or damaged. It must be replaced by the manufacturer, its service agent or similarly qualified persons in order to avoid a hazard.
- Never let the power-cord come into contact with other cables!
- This fixture must be earthed in order to comply with safety regulations.
- Don't connect the unit to any dimmer pack.
- Always use an appropriate and certified safety cable when installing the unit.
- In order to prevent electric shock, do not open the cover. There are no user serviceable parts inside.
- **Never** repair a fuse or bypass the fuse holder. **Always** replace a damaged fuse with a fuse of the same type and electrical specifications!
- In the event of serious operating problems, stop using the fixture and contact your dealer immediately.

- The housing and the lenses must be replaced if they are visibly damaged.
- Please use the original packing when the device is to be transported.
- Due to safety reasons it is prohibited to make unauthorized modifications to the unit.

Important: Never look directly into the light source! Don't use the effect in the presence of persons suffering from epilepsy.

LASER SAFETY INSTRUCTIONS:

- According to the EN/IEC 60825-1:2014 regulations, this laser falls under the classification 3B. Direct eye exposure can be dangerous.



DANGER: LASER RADIATION !

Avoid direct eye exposure! Laser radiation can cause eye damage and/or skin damage. All protective measures for a safe operation of this laser must be applied.



- This product is a so-called show laser, emitting radiation with a wavelength spectrum between 400 and 700 nm and producing lighting effects for shows.
- Laser Light is different from any other light source with which you may be familiar. The light from this product can potentially cause eye injury if not set up and used properly. Laser light is thousands of times more concentrated than light from any other kind of light source. This concentration of light power can cause instant eye injuries, primarily by burning the retina (the light sensitive portion at the back of the eye). Even if you cannot feel "heat" from a laser beam, it can still potentially injure or blind you or your audience.
- Even very small amounts of laser light are potentially hazardous even at long distances.
- Never look into the laser aperture or laser beams
- Never direct the laser beam to people or animals and never leave this device running unattended.
- This laser may only be used for shows. The operation of a class 3B show laser is only allowed if the operation is controlled by a skilled and well-trained operator.
- Depending on the classification, operating a laser product can produce laser radiation that may cause permanent eye damage and/or skin damage. The legal instructions for using a laser product vary from country to country. The user must always inform himself on the legal instructions valid in his country and apply them to his situation.
- The parent document and cornerstone of laser safety standards ANSI Z136.1 (2007) provides guidance for the safe use of lasers and laser systems by defining control measures for each of the four laser classes. This valuable document can be obtained from www.laserinstitute.org

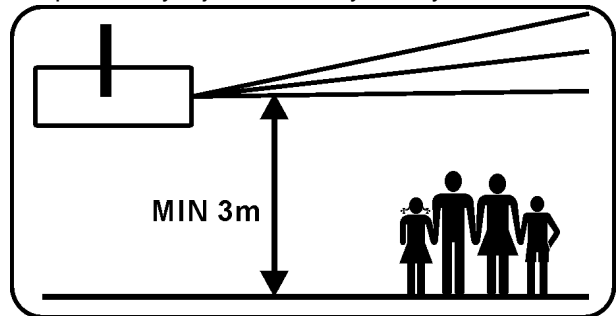

Please note that **JB SYSTEMS** cannot be made liable for damages caused by incorrect installations and unskilled operation!

	! WARNING	
LASER 3B		
AVOID EYE EXPOSURE TO BEAM		

DESCRIPTION:

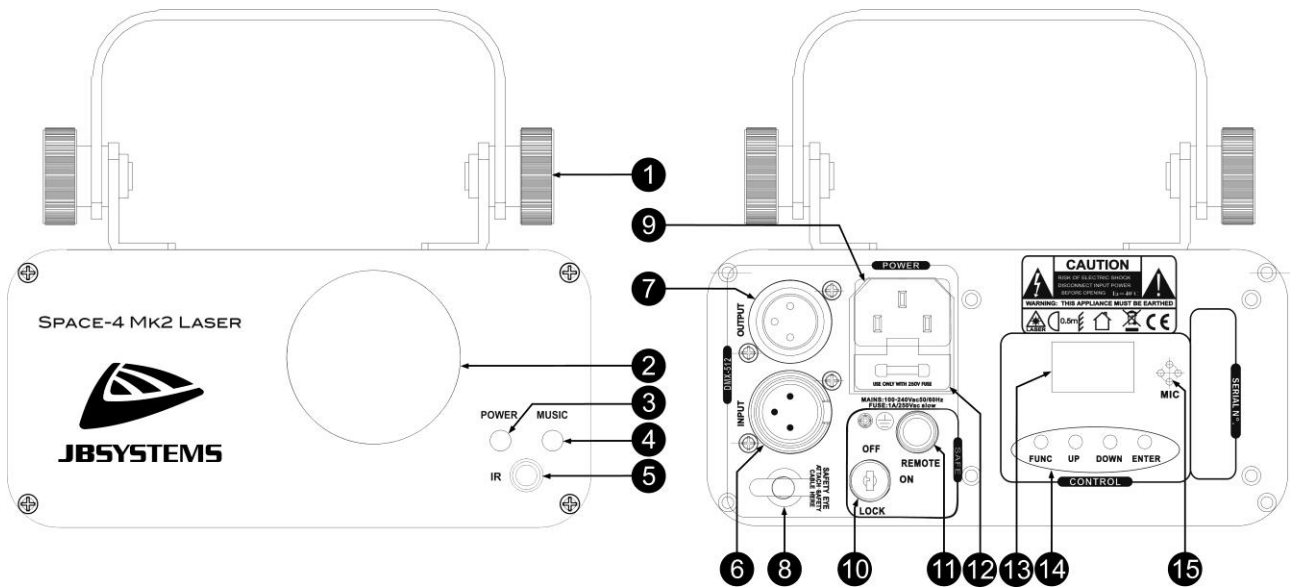

1. **HANGING BRACKET:** with 2 knobs on both sides to fasten the unit and a mounting hole to fix a mounting hook.
2. **LASER OUTPUT:** the laser beam exits the enclosure, make sure to NEVER look inside the unit through this opening while the laser effect is switched on!
3. **POWER LED:** indicates that the unit is switched on.
4. **MUSIC LED:** flashes to the sound of the music detected by the internal microphone.
5. **IR RECEIVER:** used to control the unit by the wireless remote control.
6. **DMX INPUT:** 3pin male XLR-connector used to connect universal DMX-cables. This input receives instructions from a DMX-controller or from the Master in a Master/slave setup.
7. **DMX OUTPUT:** 3pin female XLR-connector used to connect the LASER with the next unit in the DMX chain.
8. **SAFETY EYEBOLT:** used to attach a safety cable when the unit is rigged (see paragraph “overhead rigging”)
9. **MAINS INPUT:** IEC socket with integrated fuse holder, connect the supplied mains cable here.
10. **LOCK SWITCH:** used to switch the unit on/off by means of the key. Use the key to make sure only a skilled operator is able to switch the laser on.
11. **INTERLOCK input:** used to connect the optional emergency stop switch (see picture). When you push this switch the laser beam will disappear immediately.

**IMPORTANT! For your own safety we strongly recommend to connect this optional switch!
THERE WILL BE NO LASER OUTPUT WHEN THE INTERLOCK INPUT IS NOT USED!
Temporary solution: install the spare connector on the laser. (see picture)**

12. **FUSE HOLDER**
13. **DISPLAY:** shows the selected DMX address when the unit is in DMX-mode. Apart from DMX-mode you can also select 4 other working modes, see further to learn more about these modes.
14. **[FUNC-UP-DOWN-ENTER] BUTTONS:** Used to select the different functions of the laser, see further to learn how to operate the unit.
15. **INTERNAL MICROPHONE:** The built-in microphone is used to synchronize the laser show to the beat of the music.



OVERHEAD RIGGING

- **Important:** The installation must be carried out by qualified service personal only. Improper installation can result in serious injuries and/or damage to property. Overhead rigging requires extensive experience! Working load limits should be respected, certified installation materials should be used, the installed device should be inspected regularly for safety.
- Make sure the area below the installation place is free from unwanted persons during rigging, de-rigging and servicing.
- Locate the fixture in a well ventilated spot, far away from any flammable materials and/or liquids. The fixture must be fixed **at least 50cm** from surrounding walls.
- The device should be installed out of reach of people and outside areas where persons may walk by or be seated.
- Before rigging make sure that the installation area can hold a minimum point load of 10times the device's weight.
- Always use a certified safety cable that can hold 12 times the weight of the device when installing the unit. This secondary safety attachment should be installed in a way that no part of the installation can drop more than 20cm if the main attachment fails.
- The device should be well fixed; a free-swinging mounting is dangerous and may not be considered!
- Don't cover any ventilation openings as this may result in overheating.
- The operator has to make sure that the safety-relating and machine-technical installations are approved by an expert before using them for the first time. The installations should be inspected every year by a skilled person to be sure that safety is still optimal.



CAUTION EYE DAMAGE: Always position the laser in a way that prevents the audience from looking directly into the laser beams. The installation should assure that the beam will not strike the audience.

HOW TO SET UP AND CONTROL THE UNIT

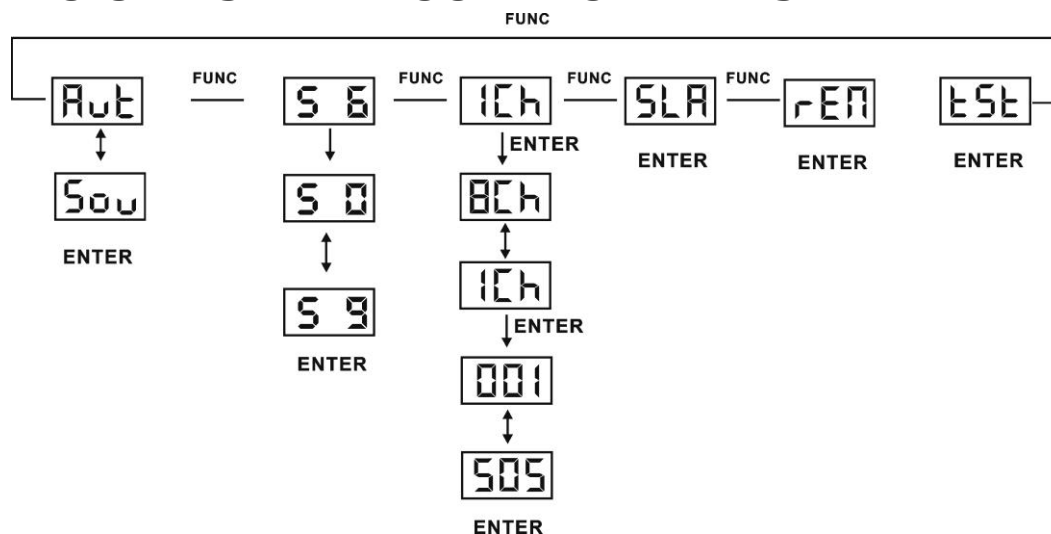

MUSIC INPUT SENSITIVITY:

The unit works to rhythm of the beat when used in standalone or master/slave mode

To set the input sensitivity, follow these steps:

- Press the FUNC-button until the display shows “S 0” ...”S 9”
- Press the ENTER-button to confirm your choice.
- Use DOWN and UP button to select a value between “S 0” (very low sensitivity) and “S 9” (high sensitivity).
- Once the mode is selected, press the ENTER button save it.

You can operate the unit in 5 ways:

1) MUSIC CONTROLLED MODE:

The laser runs a preprogrammed sequence to the rhythm of the music. Select this mode when only 1 laser is used (standalone) or when the laser is placed as the first (master) unit in a chain with several units.

- Press the FUNC-button until the display shows one of the following: Sou or Aut.

Please check carefully the Menu chart above.

- Now use the UP or DOWN buttons to select “Sou”
- Press the ENTER-button to confirm your choice.

You can connect several LASERS together: just put the first unit of the chain in one of the sound activated effect modes and all other units in “Slave mode” (display shows “SLA”) to make them all work in perfect sync!

Note: When no music is detected, the laser output will be shut off (blackout).

2) FULL AUTOMATIC MODE:

The laser automatically runs a preprogrammed sequence. Select this mode when only 1 laser is used (standalone) or when the laser is placed as the first (master) unit in a chain with several LASERS.

- Press the FUNC-button until the display shows one of the following: Sou or Aut.

Please check carefully the Menu chart above.

- Now use the UP or DOWN buttons to select “Aut”
- Press the ENTER-button to confirm your choice.

The laser automatically runs a preprogrammed sequence.

You can connect several SPACE-4 MK2 LASERS together: just put the first unit of the chain in one of the automatic effect modes and all other units in “Slave mode” (display shows “SLA”) to make them all work in perfect sync!

3) SLAVE MODE:

The laser follows the instructions given by the first SPACE-4 MK2 LASER (master) in the chain.

- Connect the DMX input of the laser to the DMX output of the previous laser in the chain.
- Press the FUNC-button until the display shows “SLA”
- Press the ENTER-button to confirm your choice.

You can connect several lasers together. Please put the first unit of the chain in “Music or automatic

mode” and all other units in “Slave mode” (display shows “SLA” to make them all work in perfect sync!

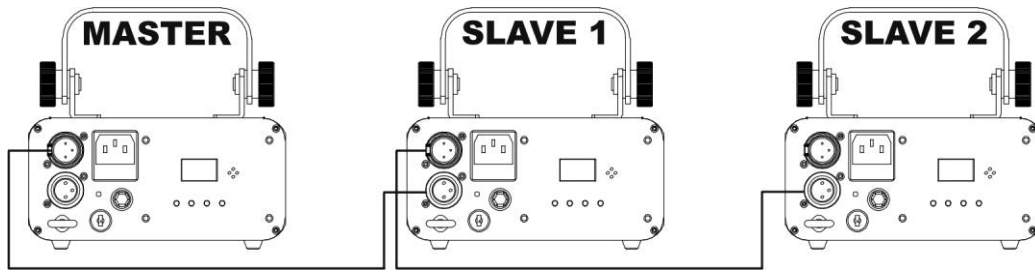

4) IR remote MODE:

The laser can be controlled by the IR remote control:

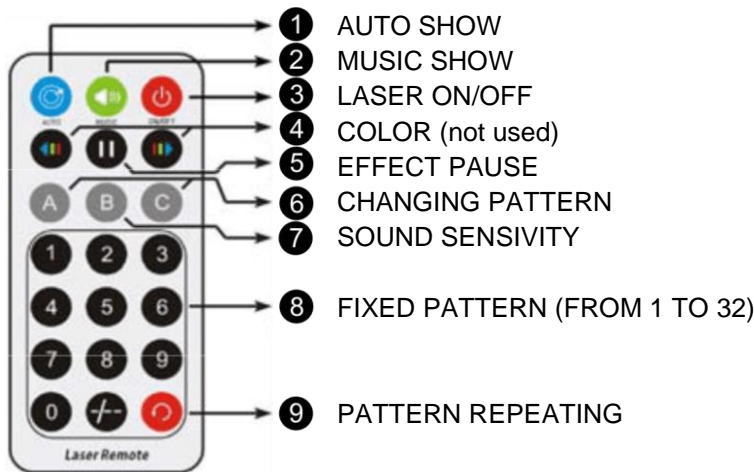

- Press the FUNC-button until the display shows: “REM”.
- Press the ENTER-button to confirm your choice.
- Now you can use your remote controller to change your settings.

Note: In any standalone mode (excepted REM and SLA), press ON/OFF for 2 second to activate remote function.

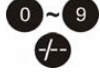

Remote control details:

Button	function	Description
	ON/OFF	In REM mode, turn on/off the laser. In any other standalone mode except SLAVE, press 2s to turn on the REM mode
	AUTO	Auto running show
	MUSIC	Sound activated show, the blue is flashing when the sound is detected.
	Sound sensitivity	In sound activated mode, press music+B+1 to 9 to change the sensitivity settings
	COLOR CHANGING	To change the color (not used)
	PATTERN CHANGING	To show and change patterns

	<p>FIXED PATTERN</p>	<p>You can select one pattern from 1 to 32</p>
	<p>PATTERN REPEAT</p>	<p>Last pattern and current pattern cycle repeating</p>

5) DMX512 MODE:

The laser can be controlled by any standard DMX-controller in 2 different DMX-modes:

- **1 CHANNEL MODE:** for extremely easy setup and use! (display shows “1Ch”)
- **8 CHANNEL MODE:** for full control on every functionalities. (display shows “8Ch”)
- Connect the DMX input of the laser to the DMX output of the previous unit in the chain or directly to the DMX-output of your controller.
- Press the FUNC-button until the display shows: “1Ch” or “8Ch”.
- Press the UP/DOWN buttons to select the DMX-mode. (1ch or 8ch)
- Press the ENTER-button to confirm your choice.
- Press the FUNC-button: the 3 digit number on the display starts blinking.
- Select the DMX-address
- Press the ENTER-button to confirm your choice.

Note: the display blinks when the unit is in DMX-mode and no DMX-signal is detected.

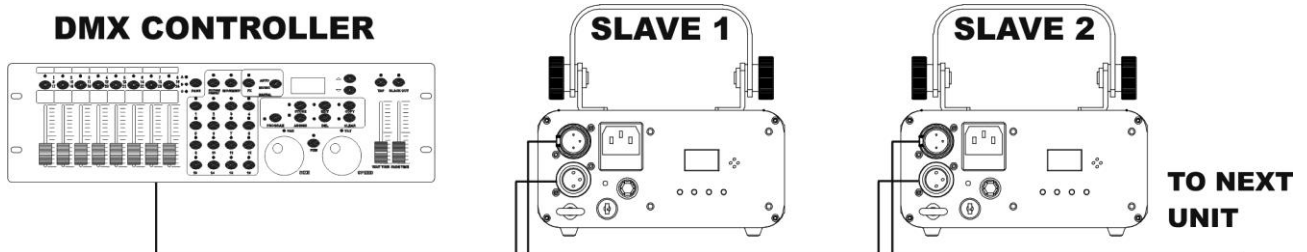

Some more information on DMX512:

The DMX-protocol is a widely used high speed signal to control intelligent light equipment. You need to “daisy chain” your DMX controller and all the connected light effects with a good quality XLR M/F balanced cable. To prevent strange behavior of the light effects, due to interferences, you must use a 90Ω to 120Ω terminator at the end of the chain. Never use Y-splitter cables, this simply won’t work!

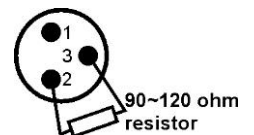

Each effect in the chain needs to have its proper starting address so it knows which commands from the controller it has to decode.

1 CHANNEL DMX-CONFIGURATION OF THE LASER:







DMX-value	function	remarks
150-255	SOU	Sound activated show
030-149	AUT	Automatic show
000-029	STANDBY	Laser output off

8 CHANNEL DMX-CONFIGURATION OF THE LASER:











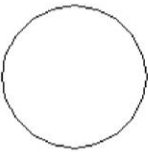
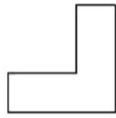

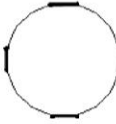

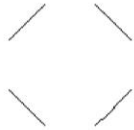

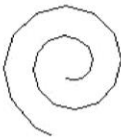
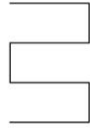



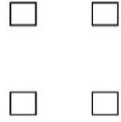
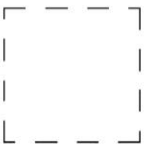

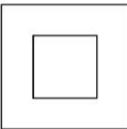

IMPORTANT REMARK: DMX Channel1 is used to set the different working modes of the laser.

- To use the laser in full 8 channel mode, channel 1 must be set to value 192 or higher.
- Depending on the DMX-values of channel1, different mode can be applied:

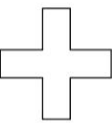
CHANNEL	VALUE	FUNCTION
CH 1 MODE	000-063	Laser Black Out 
	064-127	AUTO SHOW

	128-191	SOUND ACTIVATED SHOW (MUSIC)	
	192-255	DMX MODE (Other channels activated)	
CH 2 PATTERN	000-255	32 Patterns as shown in PATTERN LIST	
CH 3 ZOOMING	0-127	100%-5% Size	
	128-169	Zooming In	
	170-209	Zooming Out	
	210-255	Zooming In & Out	
CH 4 Y AXIS ROLLING	000-127	0 -359 degree fixed Y axis rolled	
	128-191	Clockwise rolling	
	192-255	Anticlockwise rolling	
CH 5 X AXIS ROLLING	000-127	0 -359 degree fixed X axis rolled	
	128-191	Clockwise rolling	
	192-255	Anticlockwise rolling	
CH 6 Z AXIS ROTATING	000-127	0 -359 degree fixed Z axis rotate	
	128-191	Clockwise rotating	
	128-255	Anticlockwise rotating	
CH 7 X AXIS MOVING	000-127	128 different fixed position on X	
	128-191	Clockwise moving	
	128-255	Anticlockwise moving	
CH 8 Y AXIS MOVING	000-127	128 different fixed position on Y	
	128-191	Clockwise moving	
	128-255	Anticlockwise moving	

Pattern list

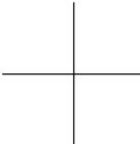
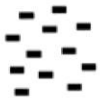
DMX	PATTERNS	DMX	PATTERNS	DMX	PATTERNS	DMX	PATTERNS
000-007		064-071		128-135		190-197	
008-015		072-079		136-143		198-205	
016-023		080-087		144-151		206-213	
024-031		088-095		152-159		214-221	
032-039		096-103		160-167		222-229	
040-047		104-111		168-175		230-237	
048-055		112-119		176-181		238-245	
056-063		120-127		182-189		246-255	

MAINTENANCE

- Make sure the area below the installation place is free from unwanted persons during servicing.
- Switch off the unit, unplug the mains cable and wait until the unit has been cooled down.

During inspection the following points should be checked:

- All screws used for installing the device and any of its parts should be tightly fastened and may not be corroded.
- Housings, fixations and installations spots (ceiling, truss, suspensions) should be totally free from any deformation.
- When an optical lens is visibly damaged due to cracks or deep scratches, it must be replaced.
- The mains cables must be in impeccable condition and should be replaced immediately when even a small problem is detected.
- In order to protect the device from overheat the cooling fans (if any) and ventilation openings should be cleaned monthly.
- The interior of the device should be cleaned annually using a vacuum cleaner or air-jet.
- The cleaning of internal and external optical lenses and/or mirrors must be carried out periodically to optimize light output. Cleaning frequency depends on the environment in which the fixture operates: damp, smoky or particularly dirty surroundings can cause greater accumulation of dirt on the unit's optics.
 - Clean with a soft cloth using normal glass cleaning products.
 - Always dry the parts carefully.
 - Clean the external optics at least once every 30 days.
 - Clean the internal optics at least every 90 days.

Attention: We strongly recommend internal cleaning to be carried out by qualified personnel!

SPECIFICATIONS

Mains Input:	AC 100~240V, 50/60Hz
Fuse:	250V 1A slow blow (20mm glass)
Total Power consumption:	12W
Sound Control:	Internal microphone
DMX connections:	3pin XLR male / female
DMX channels:	1 or 8 channels
DMX starting address:	001 → 505
Laser Power:	50mW Green CW laser ($\lambda = 515\text{nm}$)
Laser radiation class:	3B
Beam diameter @ aperture:	<5mm
Divergence (each beam)	<2 mrad
Divergence (total output)	<90°
Working temperature:	10°C to 40°C
Laser Safety Standard:	EN/IEC 60825-1:2014
Size:	148x168x80mm
Weight:	1.35kg

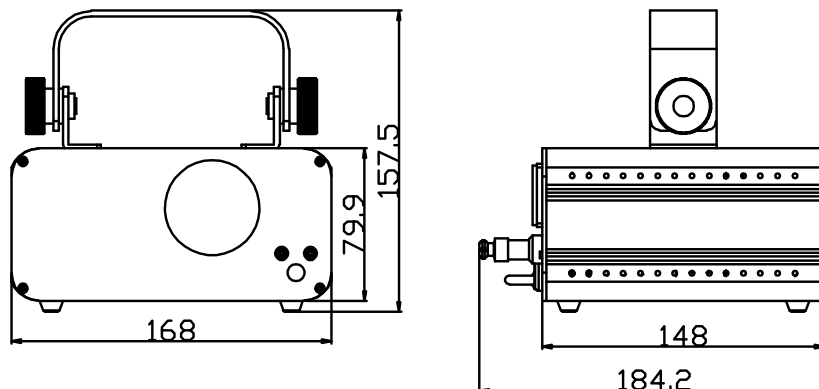

Every information is subject to change without prior notice
 You can download the latest version of this user manual on our website: www.jb-systems.eu



JB SYSTEMS

MAILING LIST

EN: Subscribe today to our mailing list for the latest product news!

FR: Inscrivez-vous à notre liste de distribution si vous souhaitez suivre l'actualité de nos produits!

NL: Abonneer je vandaag nog op onze mailinglijst en ontvang ons laatste product nieuws!

DE: Abonnieren Sie unseren Newsletter und erhalten Sie aktuelle Produktinformationen!

ES: Suscríbete hoy a nuestra lista de correo para recibir las últimas noticias!

PT: Inscreva-se hoje na nossa mailing list para estar a par das últimas notícias!

WWW.JB-SYSTEMS.EU

Copyright © 2020 by BEGLEC NV

t Hofveld 2C ~ B1702 Groot-Bijgaarden ~ Belgium

Reproduction or publication of the content in any manner, without express permission of the publisher, is prohibited.