

datavideo

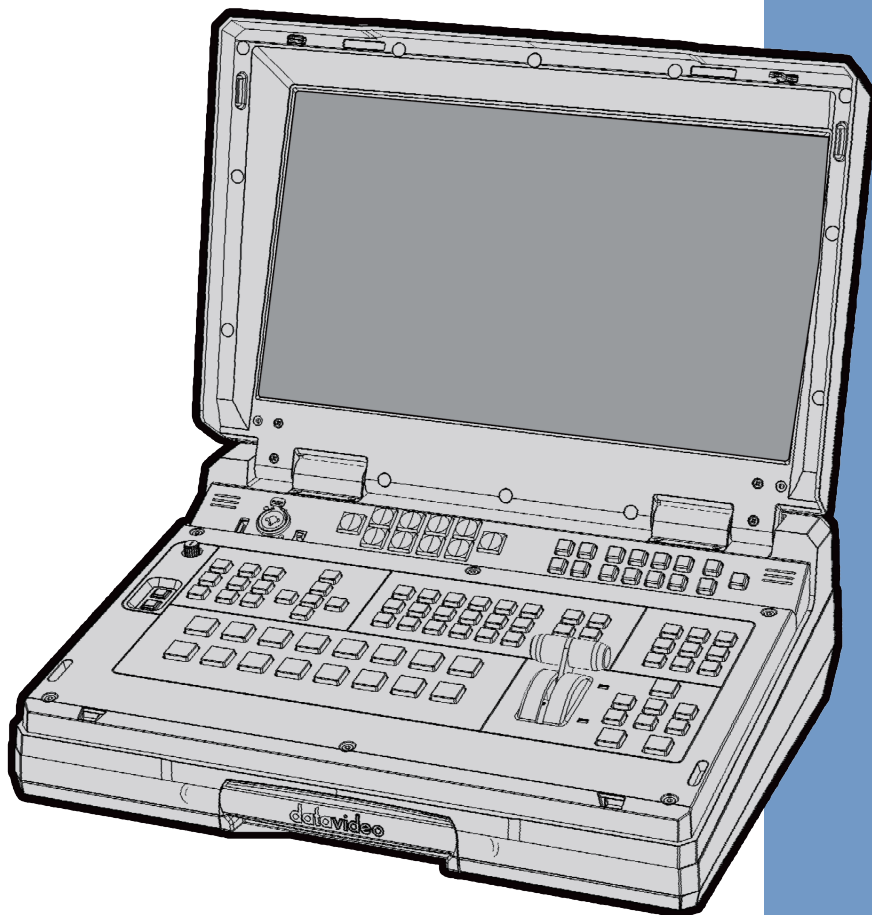

**HD/SD 6-CHANNEL
PORTABLE VIDEO STUDIO**

HS-2200

Instruction manual

www.datavideo.com

Table of Contents

FCC COMPLIANCE STATEMENT	4
WARNINGS AND PRECAUTIONS	4
WARRANTY	5
<i>STANDARD WARRANTY.....</i>	5
<i>THREE YEAR WARRANTY</i>	5
DISPOSAL	5
CHAPTER 1 INTRODUCTION.....	6
1.1 FEATURES.....	6
1.2 SYSTEM DIAGRAM.....	7
CHAPTER 2 CONNECTIONS AND CONTROLS	8
2.1 REAR PANEL OVERVIEW	8
2.2 REAR PANEL CONNECTIONS.....	8
2.3 CONTROL PANEL	11
2.4 KEYBOARD BUTTONS	12
CHAPTER 3 SWITCHER MENU OPTIONS	19
CHAPTER 4 INTERCOM & MONITOR CONTROL PANEL.....	22
4.1 INTERCOM FUNCTION	22
4.2 MONITOR FUNCTION.....	23
CHAPTER 5 MONITOR MENU OPTIONS.....	24
5.1 MAIN MENU.....	24
<i>MAIN ADJUST</i>	25
<i>COLOR.....</i>	25
<i>Information.....</i>	25
<i>Special Function.....</i>	25
<i>Factory Reset</i>	26
5.2 MONITOR FIRMWARE UPDATE PROCEDURE	26
CHAPTER 6 ADVANCED APPLICATIONS.....	27
6.1 HOW TO USE THE CG-200 SOFTWARE WITH HS-2200	27
6.2 HS-2200 VIDEO LAYERS	30
6.3 PICTURE IN PICTURE FUNCTION	31
<i>PIP Settings.....</i>	31
<i>PIP Preset and PIP Program.....</i>	31
<i>Assigning a video source input to a PIP.....</i>	31
6.4 DSK FUNCTION	32
<i>DSK Settings.....</i>	32
<i>DSK PVW and DSK PGM</i>	32
<i>Assigning an input to a DSK PVW channel for keying</i>	32
6.5 AUDIO FUNCTION	32
<i>Overview.....</i>	32
<i>AUDIO FOLLOW VIDEO</i>	33
<i>AUDIO FIXED.....</i>	33
<i>Audio Menu Options – De-embedding SDI or HDMI audio</i>	34
<i>Working with a fixed or single audio source</i>	35
<i>Switching between different embedded audio sources.....</i>	35

CHAPTER 7 APPENDICES.....	37
APPENDIX 1 FIRMWARE UPGRADE	37
<i>T-Bar Re-Calibration</i>	41
APPENDIX 2 GPI CONNECTIONS	42
APPENDIX 3 DIMENSIONS.....	43
APPENDIX 4 SPECIFICATIONS	44
SERVICE AND SUPPORT	48

Disclaimer of Product & Services

The information offered in this instruction manual is intended as a guide only. At all times, Datavideo Technologies will try to give correct, complete and suitable information. However, Datavideo Technologies cannot exclude that some information in this manual, from time to time, may not be correct or may be incomplete. This manual may contain typing errors, omissions or incorrect information. Datavideo Technologies always recommend that you double check the information in this document for accuracy before making any purchase decision or using the product. Datavideo Technologies is not responsible for any omissions or errors, or for any subsequent loss or damage caused by using the information contained within this manual. Further advice on the content of this manual or on the product can be obtained by contacting your local Datavideo Office or dealer.

FCC Compliance Statement

This device complies with part 15 of the FCC rules. Operation is subject to the following two conditions:

1. This device may not cause harmful interference, and
2. This device must accept any interference received, including interference that may cause undesired operation.

Warnings and Precautions



1. Read all of these warnings and save them for later reference.
2. Follow all warnings and instructions marked on this unit.
3. Unplug this unit from the wall outlet before cleaning. Do not use liquid or aerosol cleaners. Use a damp cloth for cleaning.
4. Do not use this unit in or near water.
5. Do not place this unit on an unstable cart, stand, or table. The unit may fall, causing serious damage.
6. Slots and openings on the cabinet top, back, and bottom are provided for ventilation. To ensure safe and reliable operation of this unit, and to protect it from overheating, do not block or cover these openings. Do not place this unit on a bed, sofa, rug, or similar surface, as the ventilation openings on the bottom of the cabinet will be blocked. This unit should never be placed near or over a heat register or radiator. This unit should not be placed in a built-in installation unless proper ventilation is provided.
7. This product should only be operated from the type of power source indicated on the marking label of the AC adapter. If you are not sure of the type of power available, consult your Datavideo dealer or your local power company.
8. Do not allow anything to rest on the power cord. Do not locate this unit where the power cord will be walked on, rolled over, or otherwise stressed.
9. If an extension cord must be used with this unit, make sure that the total of the ampere ratings on the products plugged into the extension cord do not exceed the extension cord rating.
10. Make sure that the total amperes of all the units that are plugged into a single wall outlet do not exceed 15 amperes.
11. Never push objects of any kind into this unit through the cabinet ventilation slots, as they may touch dangerous voltage points or short out parts that could result in risk of fire or electric shock. Never spill liquid of any kind onto or into this unit.
12. Except as specifically explained elsewhere in this manual, do not attempt to service this product yourself. Opening or removing covers that are marked "Do Not Remove" may expose you to dangerous voltage points or other risks, and will void your warranty. Refer all service issues to qualified service personnel.
13. Unplug this product from the wall outlet and refer to qualified service personnel under the following conditions:
 - a. When the power cord is damaged or frayed;
 - b. When liquid has spilled into the unit;
 - c. When the product has been exposed to rain or water;
 - d. When the product does not operate normally under normal operating conditions. Adjust only those controls that are covered by the operating instructions in this manual; improper adjustment of other controls may result in damage to the unit and may often require extensive work by a qualified technician to restore the unit to normal operation;
 - e. When the product has been dropped or the cabinet has been damaged;
 - f. When the product exhibits a distinct change in performance, indicating a need for service.

Warranty

Standard Warranty

- Datavideo equipment are guaranteed against any manufacturing defects for one year from the date of purchase.
- The original purchase invoice or other documentary evidence should be supplied at the time of any request for repair under warranty.
- The product warranty period begins on the purchase date. If the purchase date is unknown, the product warranty period begins on the thirtieth day after shipment from a Datavideo office.
- All non-Datavideo manufactured products (product without Datavideo logo) have only one year warranty from the date of purchase.
- Damage caused by accident, misuse, unauthorized repairs, sand, grit or water is not covered under warranty.
- Viruses and malware infections on the computer systems are not covered under warranty.
- Any errors that are caused by unauthorized third-party software installations, which are not required by our computer systems, are not covered under warranty.
- All mail or transportation costs including insurance are at the expense of the owner.
- All other claims of any nature are not covered.
- All accessories including headphones, cables, and batteries are not covered under warranty.
- Warranty only valid in the country or region of purchase.
- Your statutory rights are not affected.

Three Year Warranty

- All Datavideo products purchased after July 1st, 2017 are qualified for a free two years extension to the standard warranty, providing the product is registered with Datavideo within 30 days of purchase.
- Certain parts with limited lifetime expectancy such as LCD panels, DVD drives, Hard Drive, Solid State Drive, SD Card, USB Thumb Drive, Lighting, Camera module, PCIe Card are covered for 1 year.
- The three-year warranty must be registered on Datavideo's official website or with your local Datavideo office or one of its authorized distributors within 30 days of purchase.



Disposal

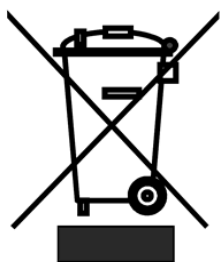

For EU Customers only - WEEE Marking

This symbol on the product or on its packaging indicates that this product must not be disposed of with your other household waste. Instead, it is your responsibility to dispose of your waste equipment by handing it over to a designated collection point for the recycling of waste electrical and electronic equipment. The separate collection and recycling of your waste equipment at the time of disposal will help to conserve natural resources and ensure that it is recycled in a manner that protects human health and the environment. For more information about where you can drop off your waste equipment for recycling, please contact your local city office, your household waste disposal service or the shop where you purchased the product.



CE Marking is the symbol as shown on the left of this page. The letters "CE" are the abbreviation of French phrase "Conformité Européene" which literally means "European Conformity". The term initially used was "EC Mark" and it was officially replaced by "CE Marking" in the Directive 93/68/EEC in 1993. "CE Marking" is now used in all EU official documents.

Chapter 1 Introduction

The HS-2200 is an HD 6 Channel Portable Mobile Cast Video Studio Packed into a durable case, HS-2200 is a convenient and powerful portable video studio. HS-2200 includes a built-in monitor for displaying all incoming input video sources as well as program and preview on a single multi-view screen.

The HS-2200 also features an 8-channel intercom system complete with tally lights, belt packs and headset (supplied with four cameraman belt packs & four 20m cables included).

1.1 Features

Video System

- 6 video inputs compatible with SD and HD video formats
- 4 HD-SDI and 2 HDMI (CH 5 & 6) video inputs
- 5 HD-SDI video outputs and each output can be switched in the menu as:
 - PROGRAM (with DSK)
 - Clean PROGRAM (without DSK)
 - Clean PREVIEW (without DSK)
 - MULTISCREEN
 - Input 1~6
- 1 HDMI video output only for multiviewer
- Keys for configuring DSK, luma key, and PiP
- Wipe, Mix & Cut Transitions
- Dual PIP and a built-in title creator system that works with Datavideo CG systems, PowerPoint and other graphics programmes

Audio System

- Built in 8 Channel Intercom/Talkback system (4 x belt packs supplied)
- Bidirectional and tally light indicator

Monitor System

- One 17.3-inch monitor with a resolution of 1600x900 dots
- Program and Preview on a multi-view screen
- The blue button eliminates the red and green component of input signals for image calibration.
- 6500K, 7500K, 9300K and custom color temperature settings in different environments.
- 16:9 or 4:3 MARK LINE for shooting adjustment
- 80% or 90% frame ratio

1.2 System Diagram

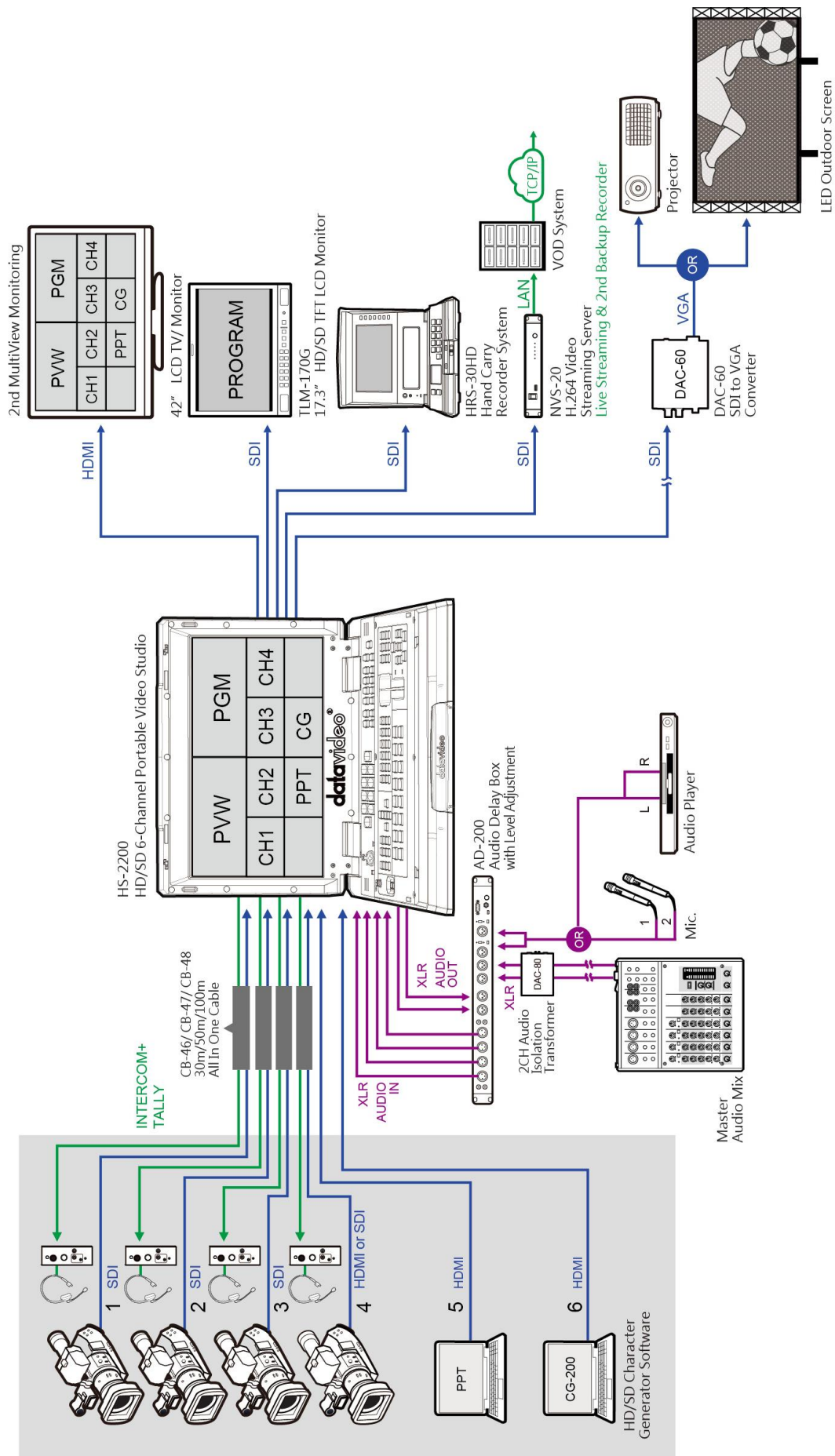

Chapter 2 Connections and Controls

2.1 Rear Panel Overview

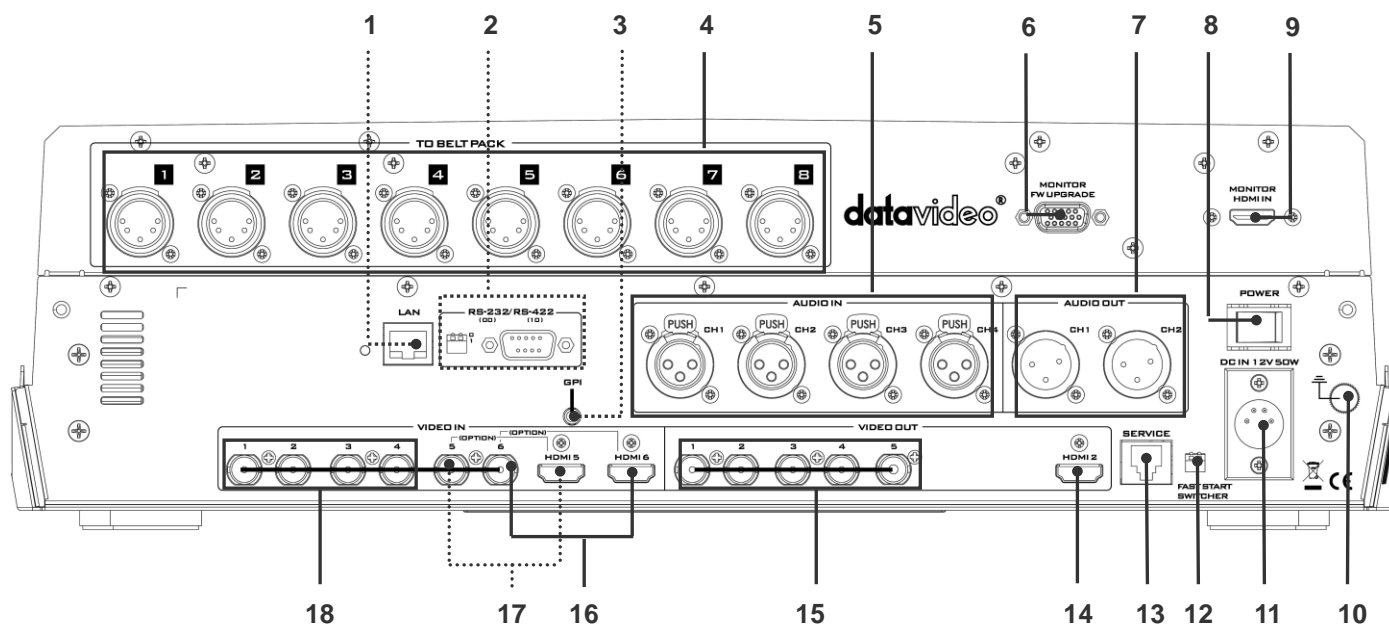

- 1. Ethernet Port for PC Control & Updates (TBD)
- 2. RS-232/422 Connector & Mini Switch 1 (TBD)
- 3. GPI Output Connector
- 4. TO BELTPACK
- 5. 3pin XLR Audio Inputs 1~4
- 6. MONITOR F/W Upgrade
- 7. 3pin XLR Audio Outputs 1,2
- 8. Power Switch
- 9. Monitor HDMI Input

- 10. Grounding Terminal
- 11. 4pin XLR Power Input Connector
- 12. Mini Switch 2
- 13. Ethernet Port for Load File & Firmware Updates
- 14. Multi View Outputs - HDMI
- 15. Video Output 1~5 – HD-SDI
- 16. Input 6 – HD-SDI / HDMI*
- 17. Input 5 – HD-SDI / HDMI*
- 18. Video Input 1~4 – HD-SDI

*Details on input 5/6 are described in “SDI Video Outputs” and “Video Input Modules” of the Rear Panel Connections Section.

2.2 Rear Panel Connections

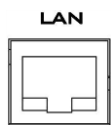

Ethernet Port
For remote control interface (TBD).

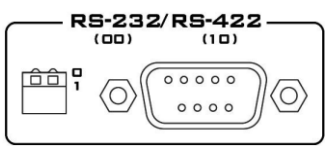

RS-232 / RS-422 Remote
For remote control interface (TBD).



GPI

The GPI socket can be used for simple external control.

Note: Please enter the HS-2200 MENU to select **GPI SETTINGS** to set up GPI function.

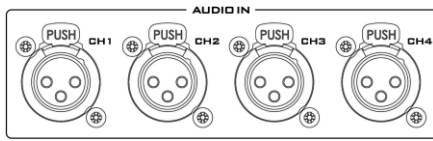

AUDIO Inputs

Supports four channels XLR Balanced Audio Input.



MONITOR F/W Upgrade

Socket is for monitor F/W upgrade.

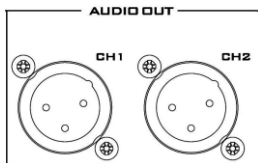

AUDIO Outputs

Supports two XLR Balanced Audio output channels.

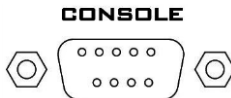

Console Port

This 9pin D-Sub connector is used to connect the Control Panel / Keyboard to the rear of the HS-2200 Main Processing unit.

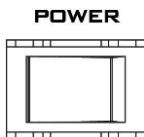

POWER SWITCH

Switches the power On / Off.



MONITOR HDMI IN

The HS-2200 provides a useful connection for confidence monitoring of HDMI sources on location.

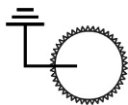

Grounding Terminal

When connecting this unit to any other component, make sure that it is properly grounded by connecting this terminal to an appropriate point. When connecting, use the socket and be sure to use wire with a cross-sectional area of at least 1.0 mm².

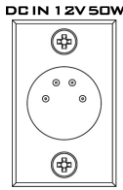

DC Input

Connect the supplied 12V 5A PSU to this 4pin XLR socket.

- Pin 1 = GND (-)
- Pin 2 = NC
- Pin 3 = NC
- Pin 4 = VCC (+)



FAST START SWITCHER

Fast Start Switcher DIP Switch

For [Firmware Upgrade](#), push both DIP switches up.

For Switcher Fast Start, push both DIP switchers down.



Service Port

This RJ45 Ethernet port is used for updating the HS-2200 firmware, or uploading logo image.



HDMI Multi-View Outputs

HS-2200 is capable of achieving multi-view monitoring by connecting multi-view monitor to the HDMI port. The HDMI output can be used for monitoring video and audio in a number of different configurations.

The HDMI connectors are located on the rear panel.

Note: HDMI multi-view output format is 1080i.

SDI Video Outputs

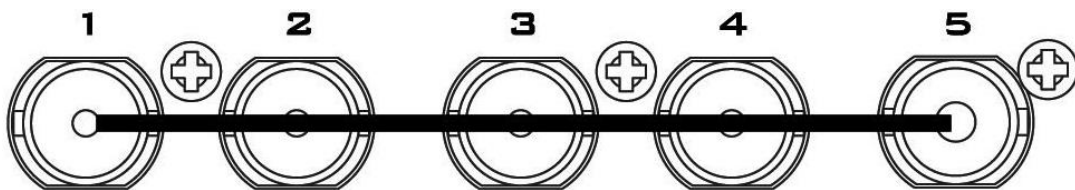

The five BNC output connectors are user defined SDI outputs. Each of these SDI outputs has the option to be:

1. Program
2. Program logo free
3. Program logo & titles free
4. Preview
5. Aux1,2,3 or 4
6. Multi screen

Note: Please enter the HS-2200 MENU to set the **OUTPUT SOURCE**.

Video Input Modules

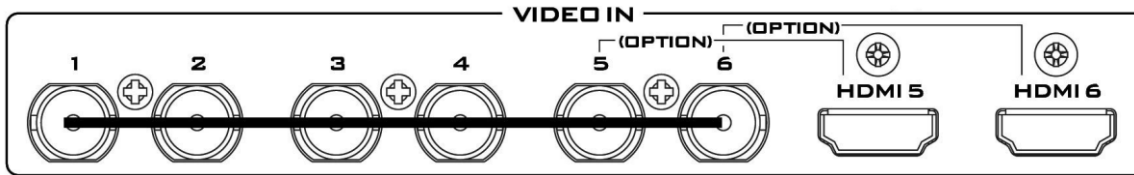

The HS-2200 is equipped with six video input channels.

Video Input set is comprised of six SDI connectors and two HDMI ports. The last two channels (#5 and #6) can be switched between SDI connector and HDMI port, i.e. the user is allowed to use CH5 and CH6 for either a SDI source or an HDMI source.

Note: The CG (picture and animation) data source is connected to the HS-2200 channels 5 and 6 via HDMI cable and edit CG function on the PC.

Note: Please enter the HS-2200 MENU to set the input source for **INPUT 5 AND 6**.

TO BELTPACK (For Intercom)

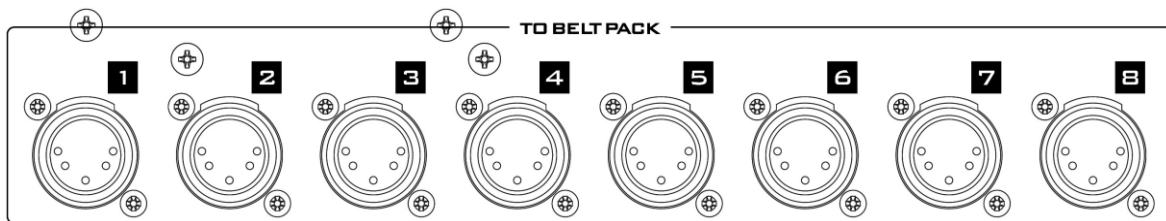

Channel Input / Output XLR Sockets

Each of the 8 channels has an XLR connector that carries bi-directional signals between the ITC-150 and ITC-100SL. All connections are contained within one cable.

2.3 Control Panel

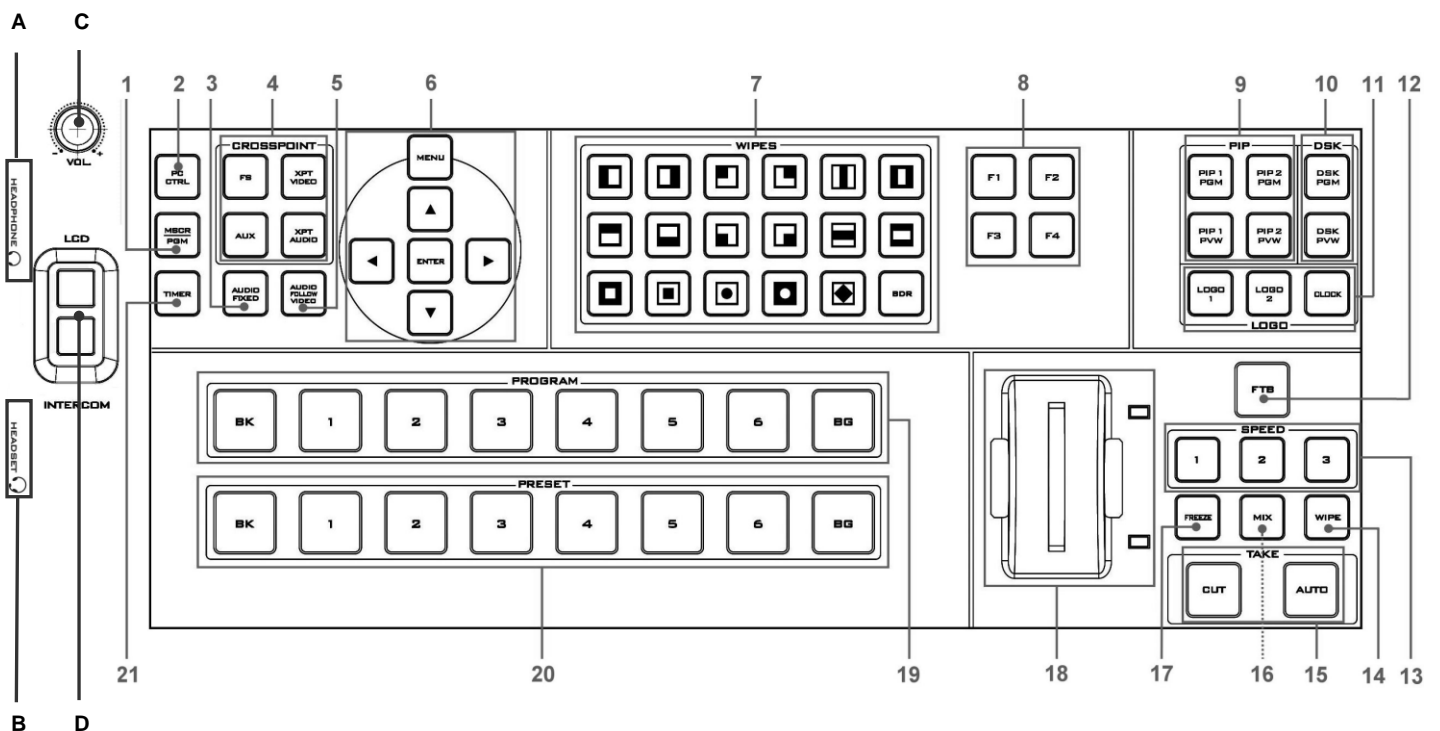

1. MSCR PGM
 2. PC Control
 3. Audio Fixed
 4. Cross Point
 5. Audio Follow Video
 6. Menu Control
 7. Transition Selection
 8. F1~F4 (TBD)
 9. PIP Selection PVW & PGM
 10. DSK Selection PVW & PGM
 11. Logos 1, 2, & Clock
 12. FTB – Fade To Black
 13. Speed Selection
 14. Wipe Function
 15. Cut & Auto Take
 16. Mix Function
 17. Freezes Function
 18. T-Bar
 19. Program Row
 20. Preset Row
 21. Timer Function
- A. Headphone
 - B. Headset
 - C. Headphone Volume Control
 - D. LCD / INTERCOM

2.4 Keyboard Buttons

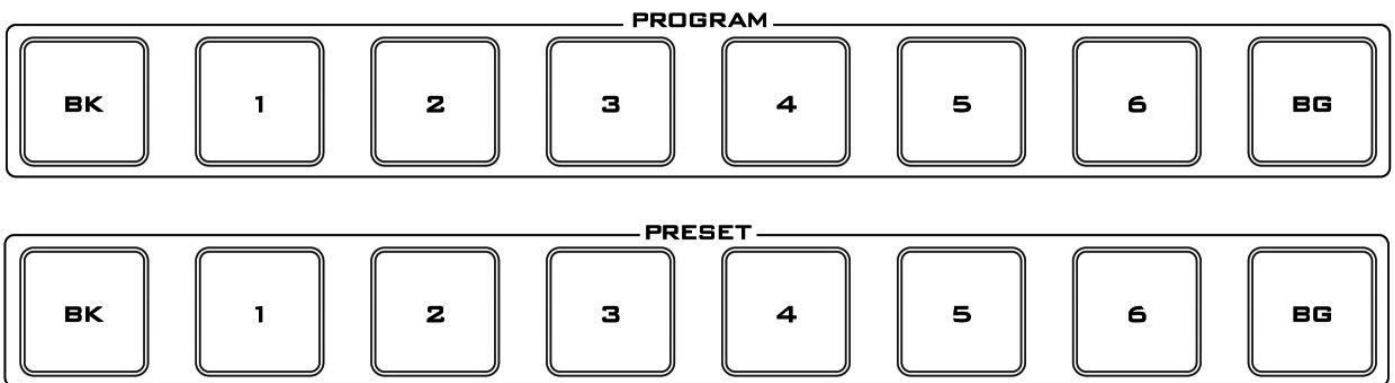

Program and Preset rows

The Program row of buttons is the active channel, this is the live output. The active channel will appear as the Program Output. You can switch or CUT from one video source to another directly on the Program row. You will see the multi view Program output change as you press different keys along this top row of buttons.

The Preset row is the cued channel; this channel will appear in the Preview window. The Preset row selection decides which input will be transitioned next when using any of the transition controls.



BK

Black background – the black background, for use on the Program and Preset row.



BG

Background button – assigns a background colour or colour bars for use on the Program and Preset row.

Note: Please enter the HS-2200 MENU and select **CONSOLE SETTINGS** to set the background colour.



MSCR/PGM

Switch the Multi Screen view or Program view.

Note: This function only works in 1080i mode.



PC Control

Press this key to control the HS-2200 via computer.



Audio Fixed

Manual selection of a mixed of audio channels fixed to a video channel at your choice.

For more details, please see the **AUDIO FIXED** section.

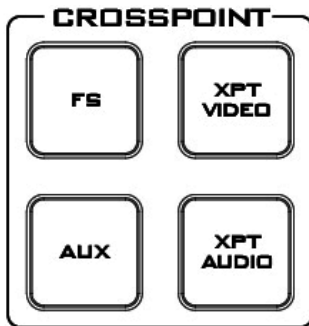

FS – Frame Store Button

The HS-2200 CH1~6 video channels, each of these channels has its own Frame Store. Each of these Frame Stores can hold one still image. This still image can be called into the production by using the FS button located at the top left corner of the HS-2200 Control Panel / Keyboard. The FS button allows the user to toggle between the still image of the Frame Store or the live video input also connected to that same video channel.

AUX Source Selection

The HS-2200 has four user defined AUX SDI output. One or all of these outputs can be set up as an auxiliary (AUX) output via a menu option.

The AUX output source can be quickly selected in the following way.

1. First press and hold down the **AUX** button. The Program row of input sources will light.
2. While still holding down the **AUX** button, press the required input on the Program row.
3. The Preset row of input sources will light. While still holding down the **AUX** button, press the required input on the Preset row.
4. The input button will flash to confirm that the AUX source is selected.

XPT Video

Assigning video source and channel setting depending on your selection.

The XPT Video source can be quickly selected in the following way.

1. First press and hold down the **XPT VIDEO** button. The Program row of input sources will light.
2. While still holding down the **XPT VIDEO** button, press the required input on the Program row.
3. The Preset row of input sources will light. While still holding down the **XPT VIDEO** button, press the required input on the Preset row.
4. The input button will flash to confirm that the audio source is selected.

XPT Audio

Assigning audio source and channel setting depending on your selection.

The XPT Audio source can be quickly selected in the following way.

1. First press and hold down the **XPT AUDIO** button. The Program row of input sources will light.
2. While still holding down the **XPT AUDIO** button, press the required input on the Program row.
3. The Preset row of input sources will light. While still holding down the **XPT AUDIO** button, press the required input on the Preset row.
4. The input button will flash to confirm the audio source is selected.



Audio Follow Video

Manual selection of one audio channel fixed to one video channel at your choice.

When you select video Channel1, the audio source and the video source will be synchronized on Channel 1.

For more details, please see the AUDIO FOLLOW VIDEO.

Menu Control

Press the **MENU** button to enter the System Configuration Menu. Press the **UP**, **DOWN**, **LEFT**, and **RIGHT** arrow buttons to navigate the menu options and change values. Use the **ENTER** button to save and confirm any setting that has been amended.

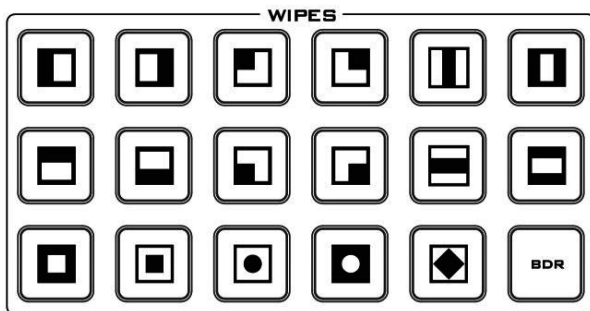
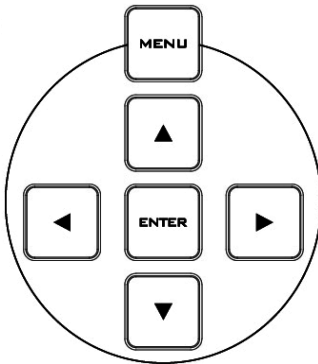

WIPES

The HS-2200 has 17 user defined wipe buttons, and a BDR button.

All wipes can have an optional colour border applied. The wipe border width and colour are chosen within the menu system.

Transitions can be performed manually using the T-Bar or automatically by using the **SPEED** and **AUTO TAKE** buttons.



Vertical Wipe Left to Right.



Vertical Wipe Right to Left.



Horizontal Wipe Top to Bottom.



Horizontal Wipe Bottom to Top.



Box Wipe from outside edges to Centre.



Box Wipe from Centre to outside edges.



Upper Left corner Wipe to Lower Right corner



Upper Right corner Wipe to Lower Left corner.



Lower Left corner Wipe to Upper Right corner.



Lower Right corner Wipe to Upper Left corner.



Circle Wipe from Centre to outside edges.



Circle Wipe from outside edges to Centre.



Vertical Wipes from Centre to Left and Right sides.



Vertical Wipes from Left and Right sides to Centre.



Horizontal Wipes from Centre to Top and Bottom.



Horizontal Wipes from Top and Bottom to Centre.



Diamond Wipe from Centre to outside edges.



Border: Enable / Disable wipe border



F1



F2

FUNCTION (F1~F4)

TBD



F3



F4



PIP 1
PGM



PIP 2
PGM

PIP Preview and PIP Program

When looking at the top right corner of the HS-2200 Control Panel / Keyboard there are four PIP keys. These are labelled Program and Preview. The upper PIP1 and PIP2 keys relate to activating Picture In Picture images on the Program outputs. The lower PIP1 and PIP2 keys relate to activating Picture In Picture images on the Multi-view or Preview outputs.



PIP 1
PVW



PIP 2
PVW

For more details, please see the **Picture in Picture Function**.



DSK
PGM

DSK Preview and DSK Program

When looking at the top right corner of the HS-2200 Control Panel / Keyboard there are two DSK keys. These are labelled Program and Preview. The upper DSK key relate to activating Down Stream Keying on the Program outputs. The lower DSK key relate to activating Down Stream Keying on the Multi-view or Preview outputs.



DSK
PVW

Please see the **DSK Function** (page 27) for more details.



LOGO 1

The LOGO 1 and LOGO 2 buttons are used to display pre-selected logos on the HS-2200 Preview and Program outputs. When the button is active the selected logo is shown. These logos are selected from the switcher's memory and positioned using a menu option.

LOGO 2 or CLOCK

The user cannot display LOGO 2 and CLOCK at the same time. Instead, use LOGO 1 and CLOCK together or use LOGO 1 and LOGO 2 together.



FTB

Fade To Black, this button fades the current video program source to black. When pressed again it acts in reverse from complete black to the currently selected program video source.

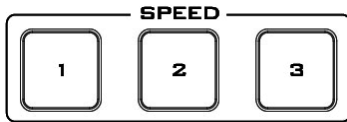

SPEED

There are three speed buttons which can be defined by the user. By pressing a speed button the user is choosing the rate of transition or time taken when using the AUTO TAKE button.

Note: Please enter the HS-2200 MENU and select **CONSOLE SETTINGS** to set up **SPEED BUTTON**.



WIPE

The WIPE button is selected when a wipe effect transition between the selected Program and Preset sources is required. This WIPE effect is produced by then moving the T-Bar manually or by pressing the AUTO TRANS button.

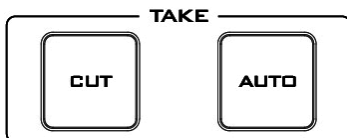

CUT

This performs a simple immediate switch from the current main source to the selected sub source. The selected transition wipe or MIX is not used.

AUTO TAKE

This performs an automated switch from the current program source to the selected Preview source. The selected transition wipe or MIX will also be used. The timing of the transition is set by the chosen Speed button.



MIX

Pressing this button selects a basic A/B Dissolve for the next transition.



FREEZE

Freeze the program source image or return to live video of the selected program source.

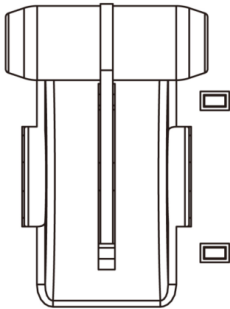

T-Bar

This performs a manually controlled transition from the current program source to the selected Preset source. The selected transition wipe or dissolve will be used. When the T-Bar has travelled as far as it can go the transition between sources is complete. The T-Bar has indicators next to it which light when the transition is complete.

The T-Bar can be operated in one of two modes which are chosen by a menu option.



TIMER

In some mixing or switching applications it is useful to have a countdown timer. It could be that the input is a pre-recorded video clip and you need to know when to be ready to switch away from it.

This countdown timer function is only seen in the status area of the HDMI multi-view output to the right of the normal Clock function. The timer can be selected for one input channel, several channels or all channels.

When the TIMER button is active and the user switches to a selected input channel the countdown starts on the HDMI multi-view.

The value of the countdown, in minutes and seconds (MM:SS).

When the countdown reaches zero the user can then switch or transition to another input channel. If the countdown reaches zero the switcher will not automatically change to the selected Preset source.

Set up the Countdown Settings

1. Select one channel of **PRESET CH1~6**
2. Press **MENU** key to enter **ON PREVIEW SETTING** to set up the **COUNT DOWN SETTING**.
3. Press **ENTER** key to save your setting, and then exit the **MENU** Mode.
4. Press **TIMER** key, and then select one channel of **PROGRAM CH1~6** (same as step 1 channel setting).



Headphone Socket

¼" / 6.3mm Stereo Headphone Socket for conventional headphones.

HEADSET

Headphone Socket (HS-2000L or Monitor)

¼" / 6.3mm Stereo Headphone Socket for conventional headphones.



Headphone Volume Control

Control Headphone or Headset volume level.

Use the Headphone section to accurately monitor any of the sources (LCD or INTERCOM).

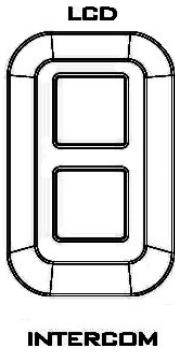

LCD / INTERCOM

Select headphone & speaker audio source from LCD or INTERCOM.

Chapter 3 Switcher Menu Options

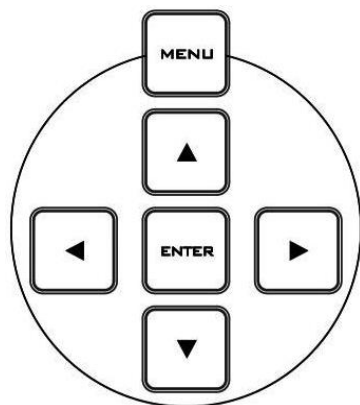

When the **ENTER** button is pressed the Main Menu list is displayed on the HDMI 1 Multi-view output.

This section covers the Menu options in the order that they appear on the HS-2200 HDMI 1 Multi-view. These settings may also appear in more detail elsewhere in this instruction manual. Options may vary depending on the firmware version in use.

Once the chosen setting has been confirmed with the **ENTER** button it is stored within the switchers non-volatile memory.

* *This table is created in HD 1080i mode.*

Version No	Firmware version number displayed in xx.xx		
1. Mode	1080i	On / Off	
	720p		
	SD 4:3		
	SD 16:9		
2. On Preview Settings	Video Input Adjustment	Brightness	Range 072 to 184
		Contrast	Range 36 to 92
		Saturation	Range 36 to 92
		Aperture	0~3
		Y-C Delay	0~7
	Audio Adjustment	Set to Nominal	On / Off
		Level	-60 / -55 / -50 / -45 / -40 / -35 / -30 / -25 / -20 / -15 / -10 / -5 / 0 / 5 / 10 / 15 / 20 / 25 / 30 / 35 / 40 / 45 / 50 / 55 / 60
		Set To Nominal	On / Off
	Count Down Settings	Down Counter is on	On / Off
		Count Down Value	00:01 ~ 60:00
Note: Each input can be selected for Count Down ON or OFF. If Count Down is ON then the Down Counter value is set in minutes and seconds (MM:SS), Max = 1 Hour or 60:00, and Default = 15 seconds or 00:15			
3. Input 5 and 6 Mode	Input 5 Input 6	SDI	On / Off
		HDMI	On / Off
	HDMI Color Mode	RGB	
		YUU_422	
		YUV_444	
		TC-200 Mode	

4. Outputs Sources	Output 1~6	Output 1~6 can be assigned to one of the following: Program Program Logo Free Program Logo & DSK Free Preview Aux 1~4 Multi-Screen		
5. Aux Selection	AUX 1~4	1~6		
6. Audio Settings	Dynamic Range (dB)	18 or 24		
	Audio Cross Point	Button 1~6	1~6	
	SDI De-EMB. Audio Setup	Input 1~6	Group 1~4 Pair 1,2	
	HDMI De-EMB. Audio Setup	Input 5,6	1~4	
	Audio (Re)-Embedding Setup	Output 1~6	1~4	
	Audio Mixing Type	X-Type, V-Type X type = A/B cross fade V type = Fade out A then fade in B		
7. PIP Settings	PIp1 PIp2	Horizontal Position	000~107	
		Vertical Position	000~108	
		Window Size	01~33	
		Border Width	00~05	
		Border Color	01~08	
8. LOGO Settings	Logo1 Logo2	Logo Selection	001~008	
		Horizontal Position	000~110	
		Vertical Position	000~124	
9. Clock Settings	Horizontal Position	000~110		
	Vertical Position	000~124		
	Set Hours	0~24		
	Set Minutes	0~59		
	Clear Seconds	On / Off		
10. DSK Settings	DSK	On / Off		
	Luma Key Mode	On / Off		
	Luma Key Level	Luma Key Level 0 (black) to 255 (white)		
11. Wipe Border Settings	Wipe 1~17	Width	0~4	
		Color	1~8	
12. Multi Screen Setting	Multi Screen Mode	Variant A/ B/ C	On / Off	
	Multi Screen Audio Setup	Preview/ Program	On / Off	
	Multi Screen Audio Indicator		On / Off	
13. Console Settings	T-Bar Audio Mixing Type	Follow T-Bar / By the END		
	T-Bar Mode	One Way Mode / Two Way Mode		
	Speed Button Setting	Speed 1 / 2 / 3	4~64	
	B/Ground: 1~8=Color ; 9=Bars		1~9	
	Button Settings	Brightness	001~004	
		Backlight is On	On / Off	
	1kHz to COLOR BAR	On / Off		

14. GPI Settings	Input Select	0~6 GPI Select by CH1~6 (0 = GPI function disable)		
	Time Delay	01~99 Delay time can be set at 01~99 frame		
	1. MODE	LEVEL	On / Off	
		PULSE	On / Off	
15. Remote Control	Ethernet	On / Off		
	DVIP board	On / Off		
16. Factory Settings	Check to enable = Reset all settings to default values.			

Chapter 4 Intercom & Monitor Control Panel

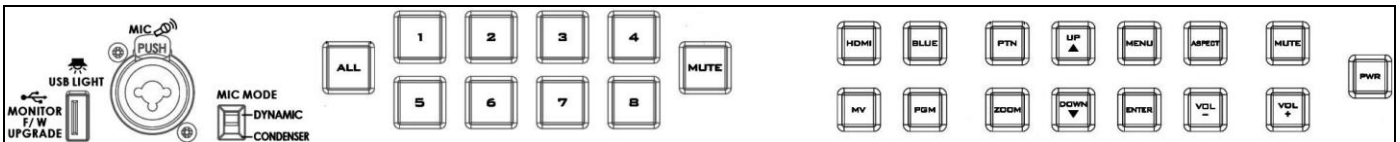

Intercom Function

Monitor Function

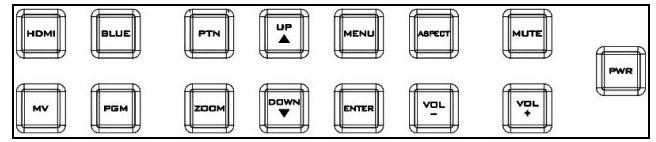
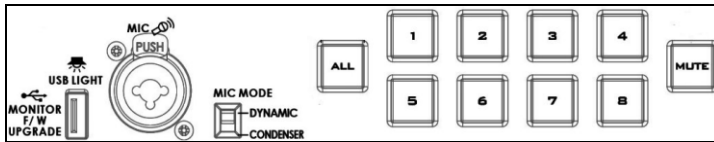

4.1 Intercom Function



USB Port

USB port for USB LED Light power supply & 17.3" monitor firmware upgrade.

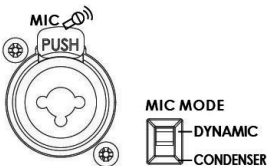

XLR Microphone Socket

Combined XLR

XLR / 1/4" (6.3mm) Jack Microphone Input for either a **Condenser** or **Dynamic Gooseneck Microphone**.

- XLR supports Condenser Microphones
- 1/4" (6.3mm) Jack supports Dynamic Gooseneck Microphone



ALL Button

Opens communication with all channels. All channels will hear communication from the operator, or from any other channel using the **TALK** button.

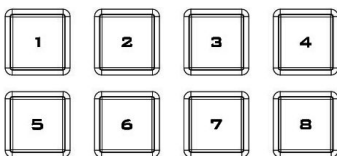

Channel Buttons 1~8

Opens communication with individual channels. More than 1 channel can be active at any given time, active channels are illuminated red.

All active channels will hear any communication from the operator or from any other active channel.

The buttons will also indicate if any channel is paging, the paging channel will flash in orange until the page is answered.



MUTE Button

Mutes all communication from the base station or any channel.

4.2 Monitor Function

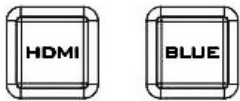

Source Select Buttons

Select the type of input you are using - HDMI, MV (multi-view), PGM (program).

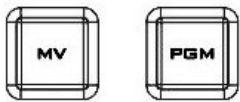

BLUE

Press this button to eliminate the red and green component of input signals. Only the blue component of an input is displayed on the screen. This allows adjustments of chroma and phase. (Phase adjustment is effective with NTSC signals).



PTN

When pressed displays internally generated SMPTE 75% Colour Bars. Press again to return to the previously selected video input.



ZOOM

This feature is designed for use with HD-SDI and HDMI sources above 720p resolution. Press this button to zoom in to the video on the display. This is strictly a zooming function and does not alter the native aspect ratio of the source pixels to fill the screen.

The **ZOOM** button allows you to toggle the Pixel Zoom feature between **zoom x1, x2, x4** and **x8**.

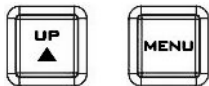

Menu Navigation Buttons

Display and navigate the set up menus - *See Menu Options for more details.*

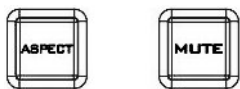
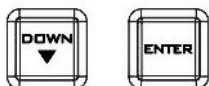

Aspect Ratio Button

Sets the Aspect Ratio to 16:9 / 4:3

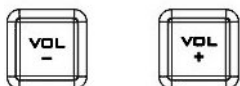

Volume Control

Adjusts the speaker / headphone volume up / down.

MUTE

Mutes the audio from the internal speakers or headphone socket.



Power

Switches the HS-2200 Monitor Power ON / OFF.

Chapter 5 Monitor Menu Options

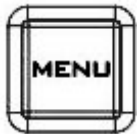

The HS-2200 Monitor can be set up via an on screen menu. To display the on screen menu press the **MENU** button.

The menus are navigated using the **Up / Down** buttons.

Press Enter button to enter or exit the **MENU** mode.



5.1 MAIN MENU

Main Options	Sub Options	Parameters	Parameters	
MAIN ADJUST	BRIGHTNESS	0~100		
	CONTRAST	0~100		
	SHARPNESS	0~100		
	SATURATION	0~100		
	TINT	0~100		
	BACK LIGHT	0~100		
	NR	HIGH / MID / LOW / OFF		
	MPEG NR	HIGH / LOW / OFF		
	VOLUME	0~100		
	EXIT			
COLOR	7500			
	9300			
	6500			
	USER COLOR	RED	0~100	
		GREEN	0~100	
BLUE		0~100		
EXIT				
SCAN SETTING	UNDER SCAN			
	OVER SCAN			
INFORMATION	H. FREQUENCY			
	V. FREQUENCY			
	RESOLUTION			
	VER.			
LANGUAGE	English [default]			
	Francis			
	Deutsch			
	Español			
	Italiano			
	Dutch			
	Português			
	Russian			
EXIT				
SPECIAL FUNCTION	OSD TIMEOUT	5-120 SEC		
	FRAME RATIO	90 / 80 / OFF		
	4:3 MARK LINE	ON / OFF		
	CENTRAL MARK	ON / OFF		

	CINEMA ZONE MARK	ON / OFF	
	AUDIO CHANNEL L*	1/2/3/4	
	AUDIO CHANNEL R*	1/2/3/4	
	EXIT		
FACTORY RESET			
EXIT			

* Selectable on PGM only; external HDMI and MV are allowed on 1 and 2 ONLY

MAIN ADJUST

The first menu to be displayed is the MAIN ADJUST Menu.

To access the MAIN ADJUST Menu press enter, the Brightness setting will be highlighted.

To adjust the Brightness press Enter again. Use the Up / Down buttons to change the setting and then press Enter to store the new value and return to the main menu.

To select a different setting (Brightness, Contrast, Saturation, Sharpness, TINT), use the Up / Down buttons. Follow the same procedure to set other values.

COLOR

To access the menu press enter so that Color Adjust option is highlighted

To access the option for the selected color setting, press enter again.

Use the Up / Down buttons to navigate the available color settings.

You can choose:

- 7500
- 9300
- 6500
- USER COLOR

Information

The System Information Menu displays Horizontal Frequency, Vertical Frequency, Resolution and the Firmware Version of the monitor.

Once selected, the information will be displayed as follows:

You will see:

H. FREQUENCY	33.7KHZ
V. FREQUENCY	60.0HZ
RESOLUTION	1920X1080I
VER.	0.11

Special Function

The Special Function Menu has settings for the OSD TIMEOUT, Frame Ratio, 4:3 MARK LINE, Central Mark, Cinema Zone Mark and Audio Channel L & R.

To access the options for the selected setting press enter again, so that the option is highlighted

Use the Up / Down buttons to navigate the available options.

You can choose:	OSD TIMEOUT	5-120 SEC
	FRAME RATIO	90 / 80 / OFF
	4:3 MARK LINE	ON / OFF
	CENTRAL MARK	ON / OFF
	CINEMA ZONE MARK	ON / OFF
	AUDIO CHANNEL L*	1/2/3/4
	AUDIO CHANNEL R*	1/2/3/4

Factory Reset

The monitor menu offers a Factory Reset option, which will return all the settings of the monitor to the factory defaults

To reset the monitor press the MENU button and then use the UP / Down button to navigate to FACTORY RESET option. Press ENTER again to reset the monitor. After a few seconds the monitor will be reset.

5.2 Monitor firmware update procedure

From time to time Datavideo may release new firmware to either add new features or to fix reported bugs in the current HS-2200 Monitor firmware. Customers can update the firmware themselves if they wish or they can contact their local dealer or reseller for assistance should they prefer this method.

This page describes the firmware update process and it should take ***approximately 15 minutes total time to complete.***

Successful firmware upgrade on HS-2200 Monitor requires:

- The latest firmware update for the **HS-2200 Monitor**.
This firmware file can be obtained from your local Datavideo office or dealer.
- USB 2.0 pen drive 128MB or larger with a USB A connector.

How to update the firmware

1. Unzip / extract the supplied zipped archive or rar folder.
2. Wipe the contents of the USB 2.0 pen drive so it is empty.
3. Transfer / copy the unzipped / extracted file to the USB 2.0 pen drive; make sure the file name is renamed to MSTFLASH.bin.
4. Plug the USB 2.0 pen drive into the USB 2.0 port labelled MONITOR F/W UPGRADE on the front of the monitor button panel.
5. Reboot **HS-2200** and the update will be automatically in progress.
6. The **HS-2200 Monitor** will reboot itself at the end of the process.

Once started ***the update process should not be interrupted in any way*** as this could result in a non-responsive unit.

Chapter 6 Advanced Applications

6.1 How to use the CG-200 software with HS-2200

The CG-200 Character Generator software allows the producer to create professional overlays with a Windows laptop or Windows PC from which the CG-200 outputs a computer generated video stream via an HDMI interface. This software works perfectly with the HS-2200’s built-in title overlay system (**TC-200**) if subtitles are a requirement in your production environment. **However, please note that the following hardware restrictions may apply when using this feature.**

- The built-in title overlay system (**TC-200**) has a better compatibility performance with ATI and Intel VGA graphics cards.
- Compatibility issue such as color difference may occur when used with NVIDIA graphics cards.

Visit Datavideo’s official website <http://www.datavideo.com/product/CG-200> to download a free copy of the latest CG-200 software. Then follow the steps outlined below to set up the CG-200 Character Generator software with the HS-2200.

1. Use an HDMI cable to connect the PC to the HS-2200 (CH-6).

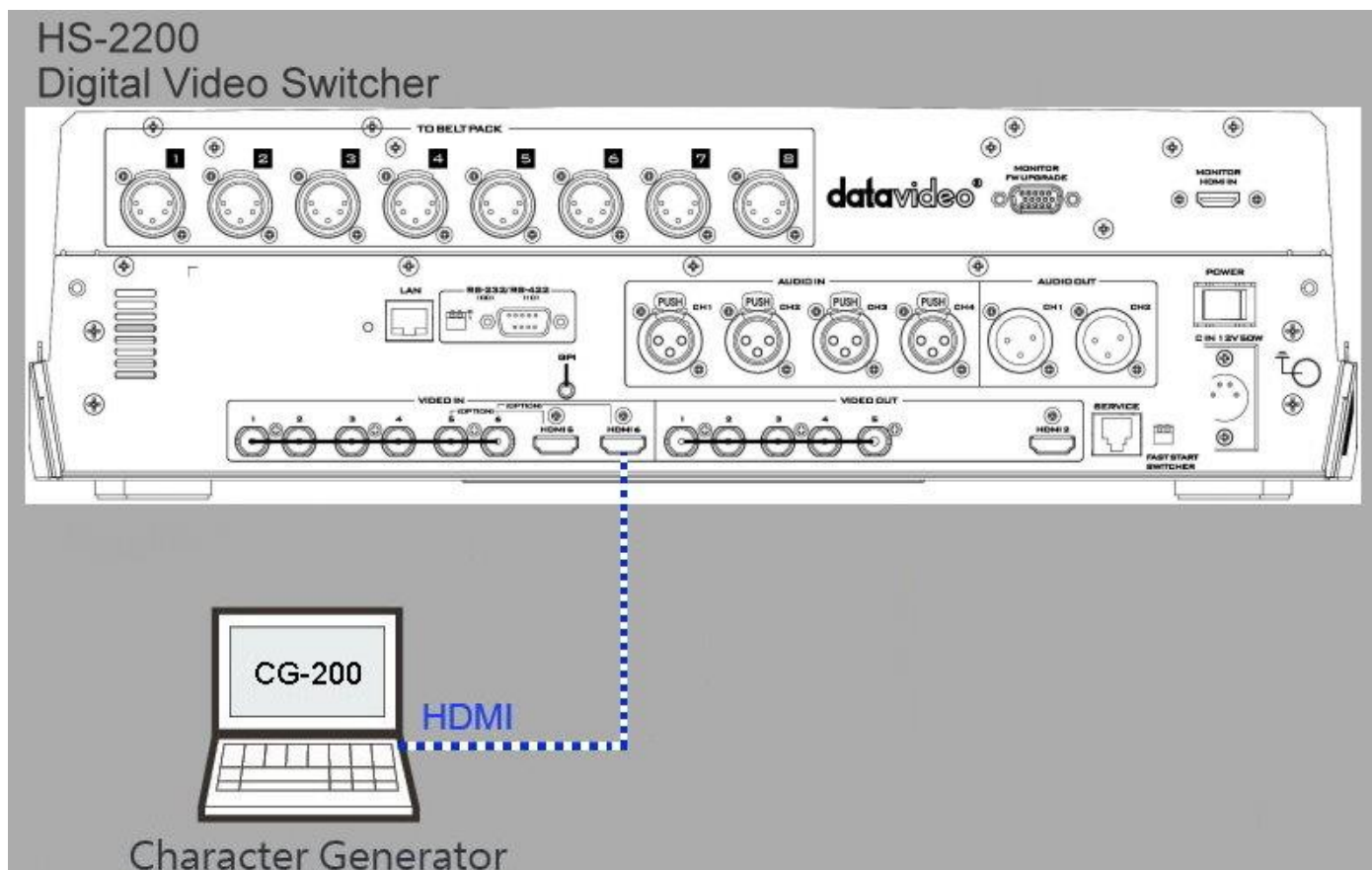

2. Enter HS-2200 Main Menu to set Video Standard.

1. Mode	1080i	Set the video to the desired standard.
	720p	
	SD 4:3	
	SD 16:9	

3. Enter HS-2200 Main Menu to set Video Input 6 to HDMI.

3. Input 5 and 6 Mode	Input 5 Input 6	SDI	On / Off
		HDMI	On / Off
		HDMI Color Mode	RGB
			YUU_422
			YUV_444
TC-200 Mode			

4. Activate DownStream Key on HS-2200 Control Keyboard. Please see the section on [DSK Function](#) for more details.

5. Install the CG-200 software on the PC.



Step1: Click the icon to install CG-200.

Step2: Follow the installation wizard to install the software.



Step3: When finished, double click the CG-200 icon  to open the Character Generator Software.

6. Click **Settings** → **Preferences** to select Video Mode (the video mode must be the same as HS-2200).

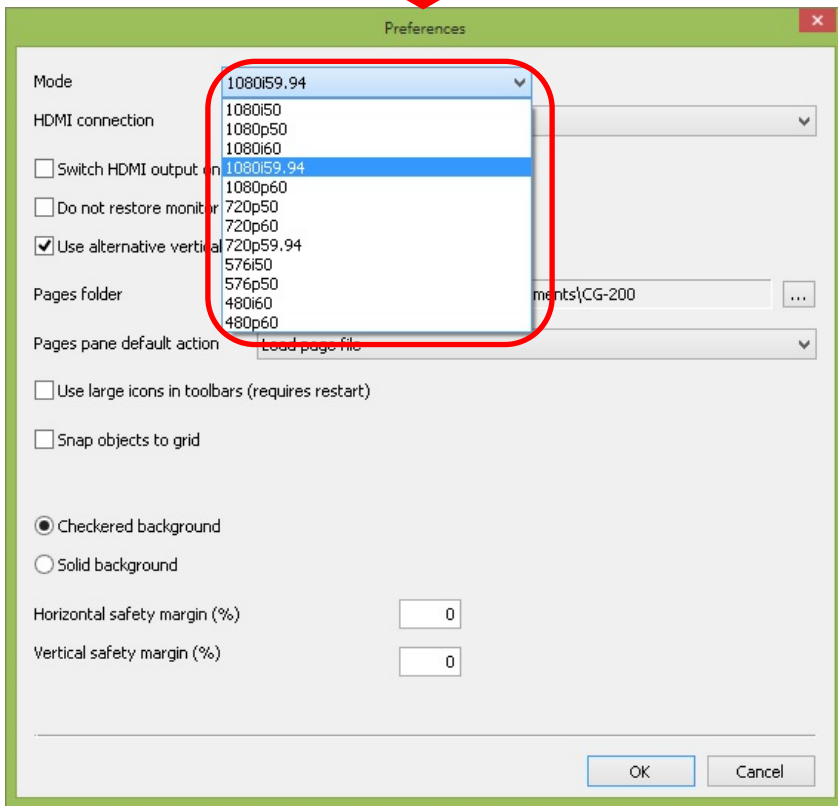
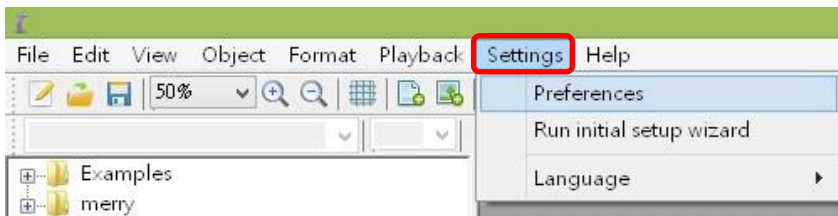

7. Select DEMO file to play the CG data (the video standard must be the same as HS-2200).

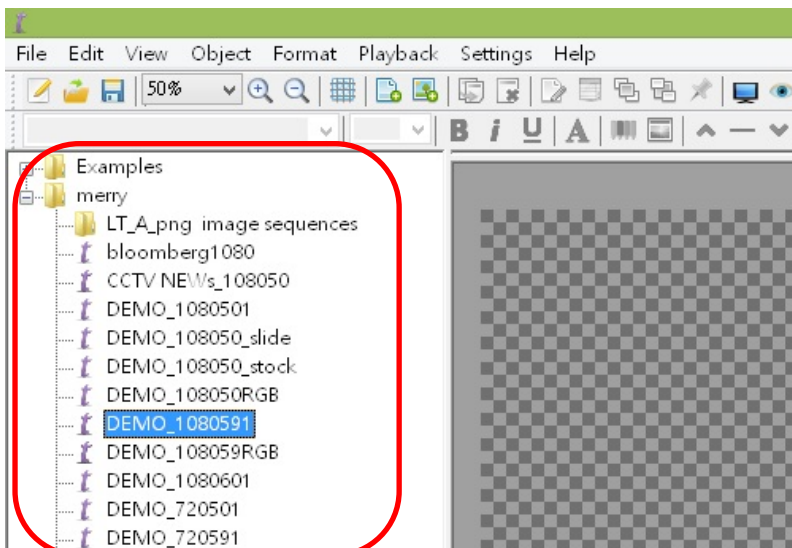

8. Set HDMI output to "ON".



9. Enter "Play all" to enable CG function.

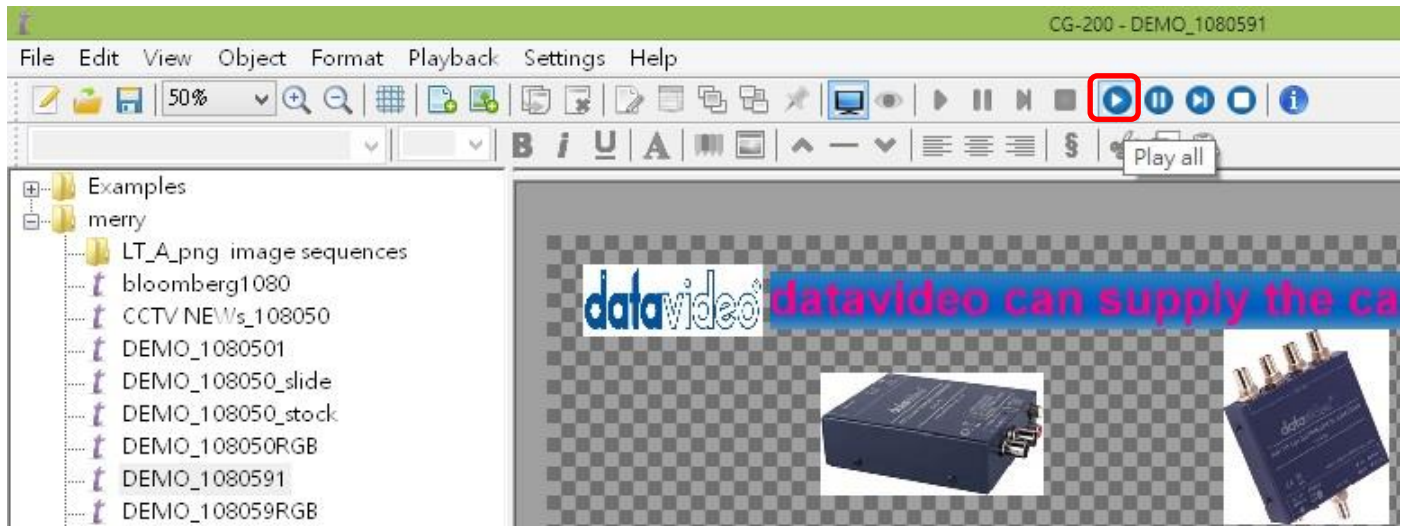

6.2 HS-2200 Video Layers

The HS-2200 is a Standard Definition or High Definition Digital Video Switcher as well as mixing video and audio sources. It has additional functions such as Picture in Picture (PIP), DSK LUMA KEY and LOGOs.

Before attempting to use the HS-2200's PIP, DSK LUMA KEY and LOGO functions it may help to first understand the order of the video layers at the HS-2200 Program (PGM) outputs.

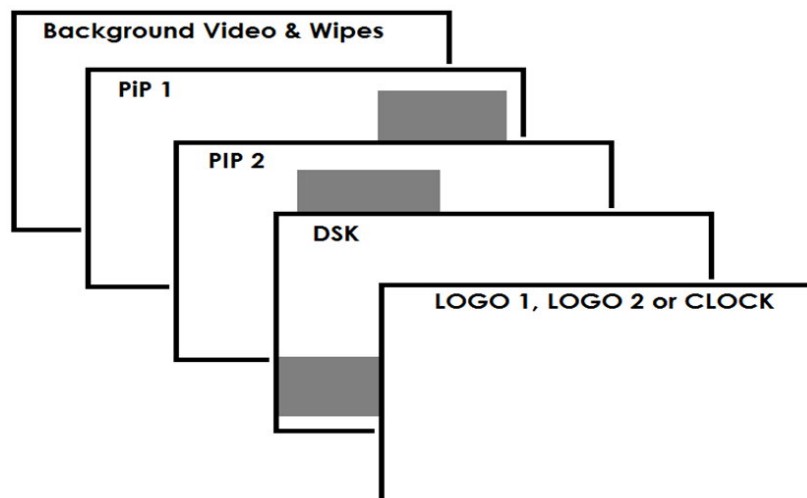

The **Background video layer** is the normal video layer when mixing and switching with the HS-2200. It occupies the whole screen area of the Program output. This layer can be hidden or partly hidden by the PIP, DSK and LOGO layers in front of it.

The **PIP 1 layer** does not occupy the whole screen and is shown in front of the Background video layer when enabled. In some setups the PIP 1 image can be hidden behind the PIP 2 image. This is not a fault. Change the position or size of the PIP 1 or PIP 2 image if required.

The **PIP 2 layer** does not occupy the whole screen and is shown in front of the Background video and PIP 1 layers when enabled. In some setups the PIP 1 image can hide the PIP 2 image. Change the position or size of the PIP 2 or PIP 1 image if required.

The **DSK layer** can occupy the whole screen. If set up incorrectly this layer can stop the video layers behind it from being seen properly. Re-adjust your DSK 1 settings or switch off the DSK1 function on the HS-2200 to restore the video behind it.

The **LOGO and Clock layer** does not occupy the whole screen and all other layers are visible through it. A logo if positioned incorrectly can partially hide an important part of the video, PIP or CG LUMA KEY layers. Typically logos or station ID bugs are placed in a corner of the screen.

NB: Where possible prepare and position the upper video layer elements in advance of the live production starting to avoid them appearing on the program output incorrectly.

Most broadcast networks have guidelines and advice on the use of video, images, music, logos and on screen text so it is best to check beforehand when planning a production. Do not use copyright protected content until you have the relevant permissions. Information on royalty free video, images and music is widely available, speak to your local dealer or search for advice on the internet.

6.3 Picture in Picture Function

The HS-2200 Picture in Picture function allows you to place one or two smaller PIP images over a chosen full size background image. The smaller PIP images can be set to pre-defined sizes and positioned almost anywhere within the Preset/Program screen area. These PIP windows can also have a coloured border applied, and can be brought into the production with a default PIP dissolve transition.

PIP Settings

Before trying to activate the PIP function it is best to understand how to set up or choose the right options for your production. Press the **ENTER Key** in the **MENU** area of the HS-2200 keyboard. Navigate to the **PIP Settings** option using the down arrow key. The PIP menu options provided here are:

PIP Settings	PIP1	Horizontal Position = 000 to 107 (Left to right)
	PIP2	Vertical Position = 000 to 108 (Lower to Upper)
		Window Size = 1 (small) to 33 (large)
		Border Width = 0 (OFF), 1 (Thin) to 5 (Thick)
		Border Color 1 = White, 2 = Yellow, 3 = Light Blue, 4 = Green, 5 = Purple, 6 = Red, 7 = Dark Blue, 8 = Black.

PIP Preset and PIP Program

When looking at the top right corner of the HS-2200 Control Panel / Keyboard there are four PIP keys. These are labelled Program and Preset.

The upper PIP1 and PIP2 keys relate to activating Picture In Picture images on the Program outputs.

The lower PIP1 and PIP2 keys relate to activating Picture In Picture images on the Multi-view or Preview outputs.

Assigning a video source input to a PIP

Using the lower PIP1 or PIP2 buttons you can assign a selected video input to the chosen PIP video layer.

1. First press and hold down the required PIP button on the lower row. The Preset row of input sources will light.
2. While still holding down the PIP button, press to select the required input from the Preset row.

3. The input will flash to confirm it is selected.

This selection will also be confirmed on the HDMI Multi-view, with a P1 or P2 label shown next to the selected input image.

6.4 DSK Function

The HS-2200 has two Down Stream Keys (**DSK PGM**, **DSK PVW**). This means it is able to take a key source video input and replace the white or black parts of this image with the video from another source. If the input video carries an alpha channel it is also possible to key in this way too.

DSK Settings

Before trying to activate the DSK function it is best to understand how to set up or choose the right options for your production well in advance of the production.

Press the **ENTER Key** in the **MENU** area of the HS-2200 keyboard. Navigate to the **DSK Settings** option using the down arrow key. The DSK menu options provided here are:

DSK Settings	Titles + α Channel Luma Key Mode Luma Key Level	Luma Key Level 0 (black) to 255 (white)
---------------------	----------------------------------------------------------------------------------------------	------------------------------------------------

DSK PVW and DSK PGM

When looking at the top right corner of the HS-2200 Control Panel / Keyboard there are two DSK keys. These are labelled Program and Preset.

The upper DSK PGM key relates to activating Down Stream Keying on the Program outputs.

The lower DSK PVW key relates to activating Down Stream Keying on the Multi-view or Preview outputs.

Assigning an input to a DSK PVW channel for keying

Using the lower DSK PVW button you can assign a selected video input to the chosen DSK video layer.

1. First press and hold down the DSK PVW button on the lower row. The Preset row of input sources will light.
2. While still holding down the DSK PVW button, press to select the required input from the Preset row.
3. The input will flash to confirm it is selected.

This selection will also be confirmed on the HDMI Multi-view, with a T1 label shown next to the selected input image.

6.5 AUDIO Function

Overview

The HS-2200 has the ability to take audio from several sources such as XLR analogue, SDI and/or HDMI inputs. The audio can be embedded onto the HDMI and SDI outputs and/or fed to the analogue XLR audio connections.

When using the audio functions of the HS-2200 switcher you may de-embed audio from selected SDI or HDMI inputs and then output this audio from the XLR outputs of the switcher to a separate audio mixer like the Datavideo AM-100 audio mixer.

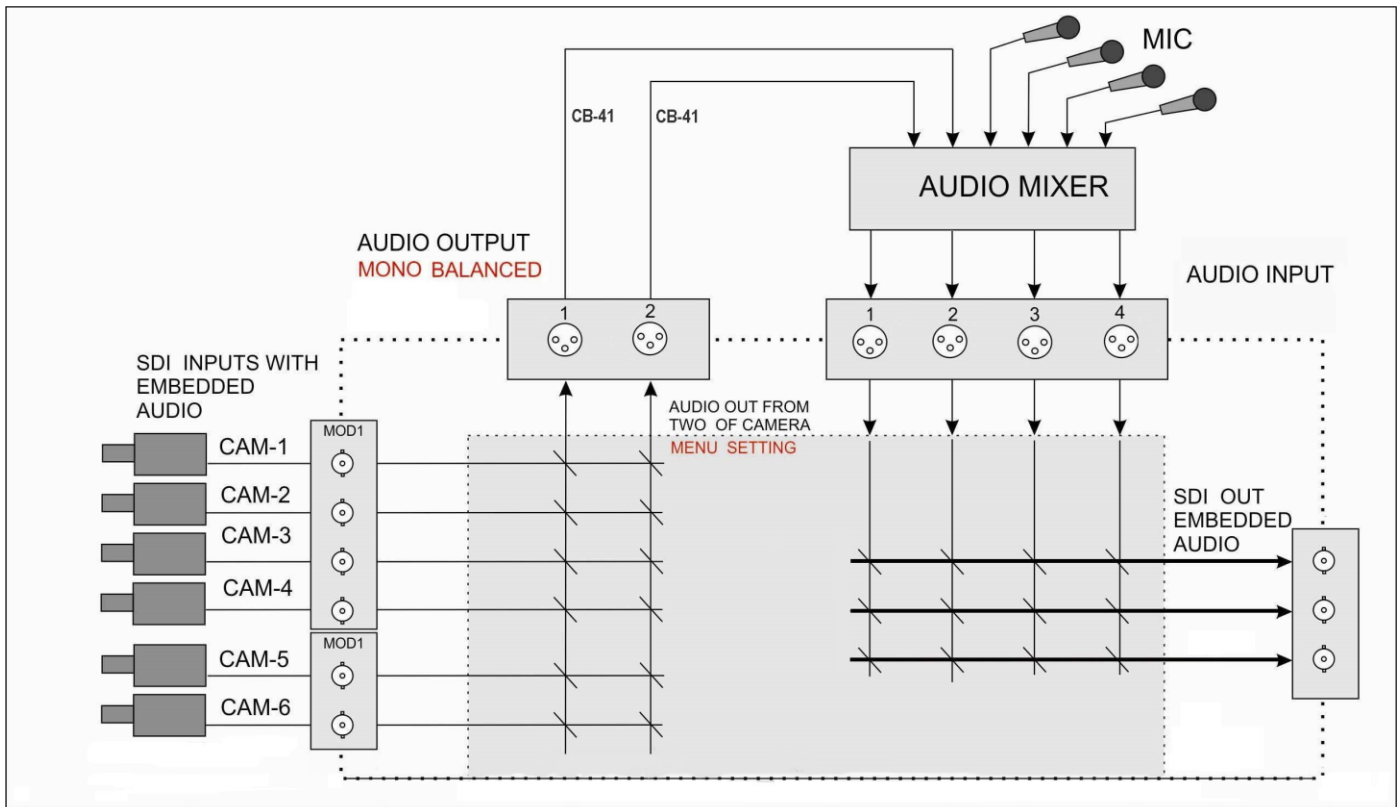

Once the audio is mixed externally with any microphones or audio sources it can then be fed back into the HS-2200 on the analogue XLR inputs. The HS-2200 can then embed this externally mixed audio on to the Program SDI outputs.

AUDIO FOLLOW VIDEO



AUDIO FOLLOW VIDEO function is also known as audio follow video. This means that the audio source will switch with the corresponding video input, and actually follow the T-bar function. The active audio is de-embedded and sent to the audio output terminals for processing and/or audio levelling/ and or adding more audio sources. The resulting audio will return and be connected to the audio inputs for the purpose of (re)-embedding the audio to the SDI output. The selection of the audio groups determines the SDI channel that the audio will be embedded to exactly.

AUDIO FOLLOW VIDEO function is primarily used in talk show or live news broadcasting. Voices of different guests are directly collected by the corresponding cameras, thus, when the program director switches between different guests, the video is switched at the same time with voice of the guest during program broadcasting. This function is definitely an indispensable function during live broadcasting.

AUDIO FIXED



The **AUDIO FIXED** method, allows a user to manually select which audio input can be matched to the SDI video input and assigned to the audio output terminals, which is shown in the example below:

The table below illustrates that the sound of video input 1 is used for all individual video inputs.

HS-2200 Audio INPUT Channel

HS-2200 Assigned Audio Output Channel

AUDIO ASSOCIATIONS	INPUT 1 (BUTTON 1)	1
	INPUT 2 (BUTTON 2)	1
	INPUT 3 (BUTTON 3)	1
	INPUT 4 (BUTTON 4)	1
	INPUT 5 (BUTTON 5)	1
	INPUT 6 (BUTTON 6)	1

The **AUDIO FIXED** function is mainly used in big (concert) events and (wedding) parties. One camera picks up the audio of the audience and/or ambience of that video input 1, which is assigned to be sent to the audio output. The other cameras are assigned to this same audio of video input 1. When the operator switches between the video sources, the sound of video input 1 remains on all the time.

Audio Menu Options – De-embedding SDI or HDMI audio

Using the following HS-2200 menu options audio can be selected from the SDI or HDMI video inputs.

SDI De-EMB. Audio Setup	Inputs 1 to 6	User choice of	Group 1,2,3 or 4 Pair 1 or 2
HDMI De-EMB. Audio Setup	Input 5 or 6	User choice of	Pair 1,2,3 or 4

As each SDI / HD-SDI source can have up to sixteen channels of audio, and HDMI eight channels, we need to choose the audio channels with the options above and by the following reference tables.

SDI Inputs Embedded Audio		
Group	Stereo Pair	Channel
Group 1	Stereo pair 1	1
		2
	Stereo pair 2	3
		4
Group 2	Stereo pair 3	5
		6
	Stereo pair 4	7
		8
Group 3	Stereo pair 5	9
		10
	Stereo pair 6	11
		12
Group 4	Stereo pair 7	13
		14
	Stereo pair 8	15
		16

HDMI Inputs Embedded Audio	
Stereo Pair	Channel
Stereo pair 1	1
	2
Stereo pair 2	3
	4
Stereo pair 3	5
	6
Stereo pair 4	7
	8

In some cases there may only be two channels of audio associated with the video: Stereo Pair 1.

Working with a fixed or single audio source

Example 1:

We have two mono mics (channels 1 & 2) connected to an HD camera. These embedded audio channels are then sent from the output of this camera (HD-SDI) to the HS-2200 switcher. If we want to only hear these two audio channels regardless of the video channel used then we would set up the switcher in the following way.

Press the ENTER key in the MENU area of the HS-2200 keyboard to display the on screen menu on the AUDIO ASSOCIATION of AUDIO SETTING.

Change the Audio Association settings in the menu system to show a value of 1 for each video input channel. Press the ENTER key to store the audio values chosen for each video input.

Change the SDI Embedded Audio setting in the switcher's menu system to show a value of Group 1 and Pair 1. Press the ENTER key to store the audio values chosen for each video input.

Now exit the menu by pressing any wipe key and look at the **AUDIO FIXED** button in the wipes area of the keyboard.

Select the **AUDIO FIXED** status with this button when looking at the status area of the HDMI multi-view. The button will be backlit red.

Switching between different embedded audio sources

Example 2:

We have two mono mics each connected to a different HD camera. The embedded audio is then output from each camera, HD-SDI, to the HS-2200 switcher. If we want to hear the audio from each camera as the video channels are switched, **audio follows video**, and then we would set up in the following way.

Press the ENTER key in the MENU area of the HS-2200 keyboard to display the on screen menu on the AUDIO ASSOCIATION of AUDIO SETTING.

Change the **Audio Association** settings in the menu system to show a value of 1 for each video input channel that is associated with audio input 1. Then change to a value of 2 each video input channel that is associated with audio input 2. Press the **ENTER** key to store the audio values chosen for each video input.

Change the **SDI Embedded Audio** setting in the switcher’s menu system to show a value of Group 1 and Pair 1. Press the **ENTER** key to store the audio values chosen for each video input.

Now exit the menu by pressing any wipe key and look at the **AUDIO FIXED** button in the wipes area of the keyboard.

Select the **AUDIO FOLLOW VIDEO** status with this button when looking at the status area of the HDMI multi-view. The button will be off. The status area is located just below or near the Preset image on the HDMI multi-view monitor.

When switching between the video sources the audio sources will also change. We can choose how the audio will change sources, whether it is a clean cut (immediate switch) or some sort of transitioned change (cross fade or fade out & in). To do this we would need to set up with the following menu options.

Auto Audio Mixing Type	User choice of	X type or V type Tick selection	X type = A/B cross fade V type = Fade out A then fade in B
T-Bar Audio Mixing Type	Tick selection of	Follow auto audio mixing type (use above option) By the end (clean cut or immediate audio switch)	

Chapter 7 Appendices

Appendix 1 Firmware Upgrade

Datavideo usually releases new firmware containing new features or reported bug fixes from time to time. Customers can either download the HS-2200 firmware as they wish or contact their local dealer or reseller for assistance.

This section outlines the firmware upgrade process which should take **approximately 10 minutes to complete**. The existing HS-2200 settings should persist through the **firmware upgrade process, which should not be interrupted once started** as this could result in a non-responsive unit.

A working HS-2200 will require:

- The latest firmware update file for the HS-2200. This can be obtained from your local Datavideo office or dealer.
- The HS-2200 Power Supply
- The SEConfig Software
- A Windows 7 Computer with Ethernet Port
- An Ethernet Cable

To change the HS-2200 video standard:

1. Switch off the HS-2200 and shut down the Computer.
2. Connect the HS-2200 rear panel to the Windows 7 Computer using an Ethernet cable.
3. Turn on the Windows 7 Computer.
4. Unzip the firmware update folder to the Computer Desktop for easy access.
5. Double click the firmware update icon to launch the Flash Update Utility.



FlashUpdate_V3.93

6. Check the supported devices list which should display HS-2200 and then click **NEXT**.

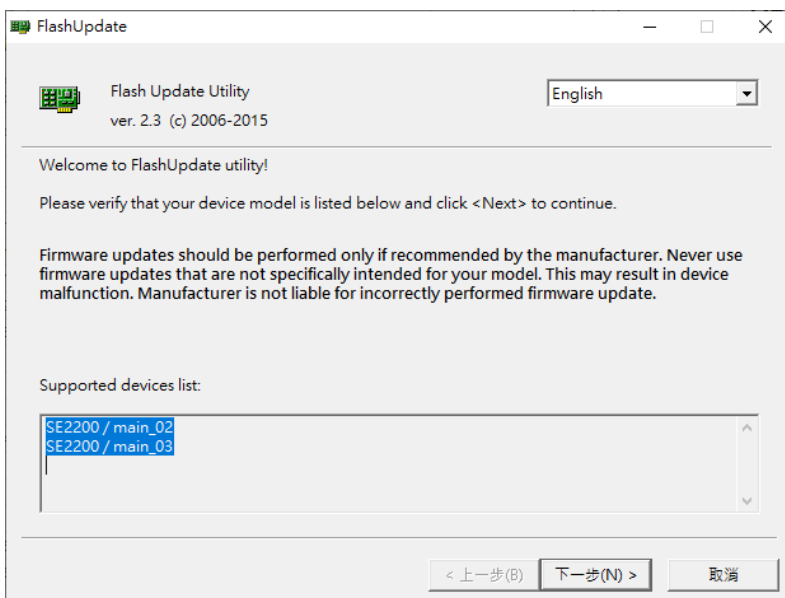

7. The following window will be displayed. Select “Device is connected via Ethernet” and then click **NEXT**.

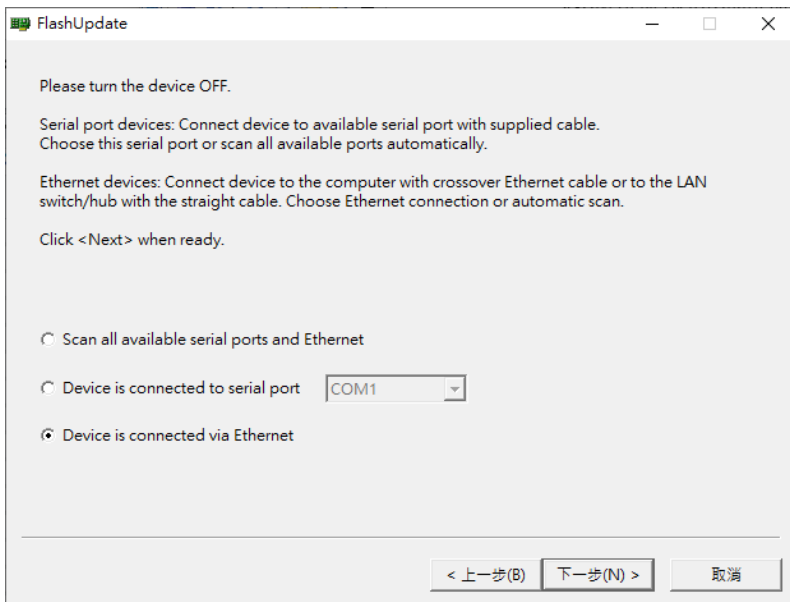

8. As soon as the following window is displayed, you can now **POWER ON** the **HS-2200** which will be discovered by the Computer.

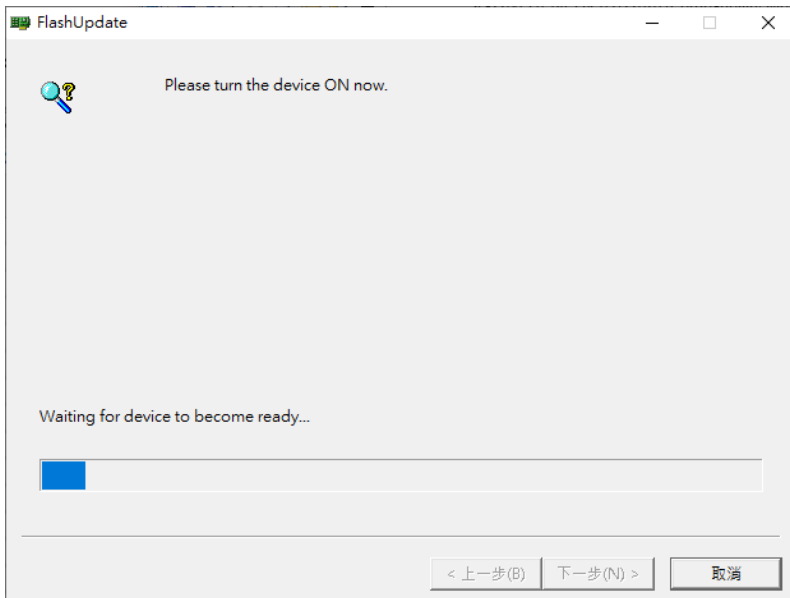

9. Select “**Manually select a firmware version**” and then click **NEXT**.



10. Click **Yes button** to proceed.

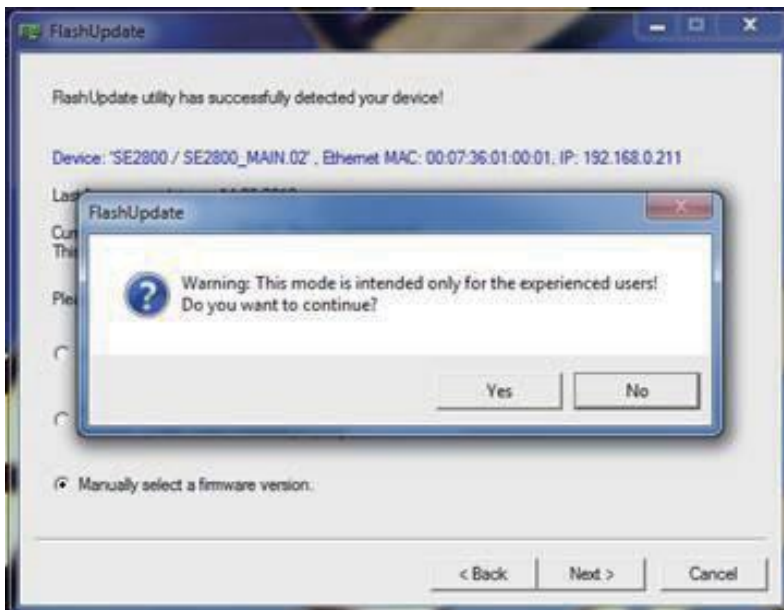

11. Select the desired standard. The available standards are:

- **1920x1080i 50**
- **1920x1080i 59.94**
- **1920x1080i 60**

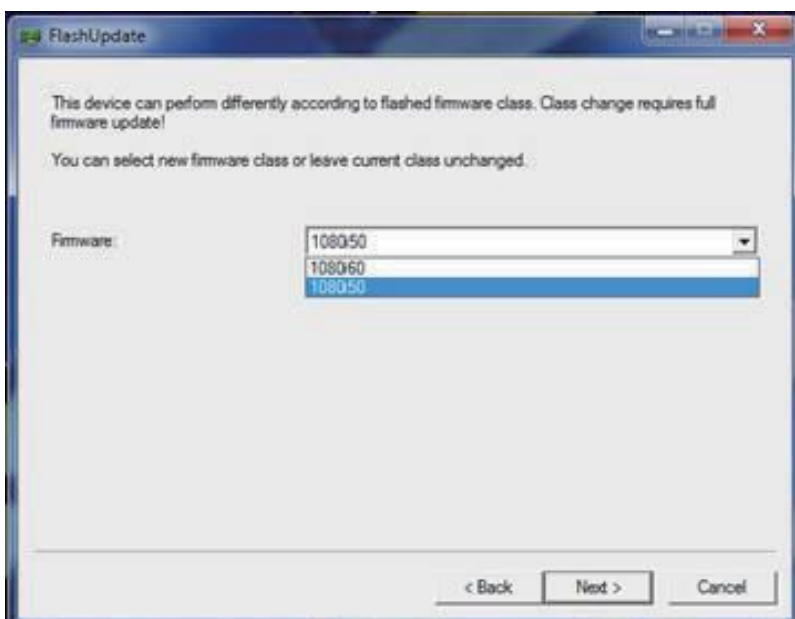

12. Select and update the corresponding firmware.

13. Click **NEXT** at the bottom of the flash update window and then click **Yes button** to proceed.

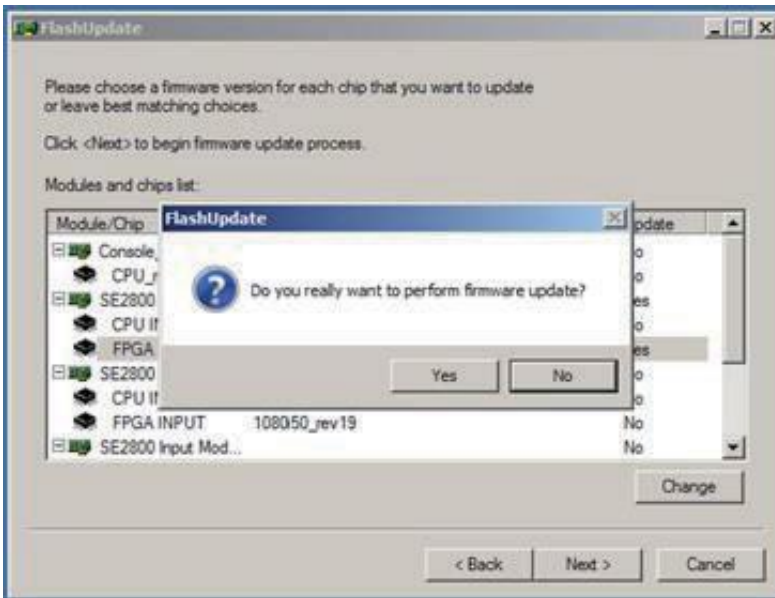

14. Wait for the update to finish.

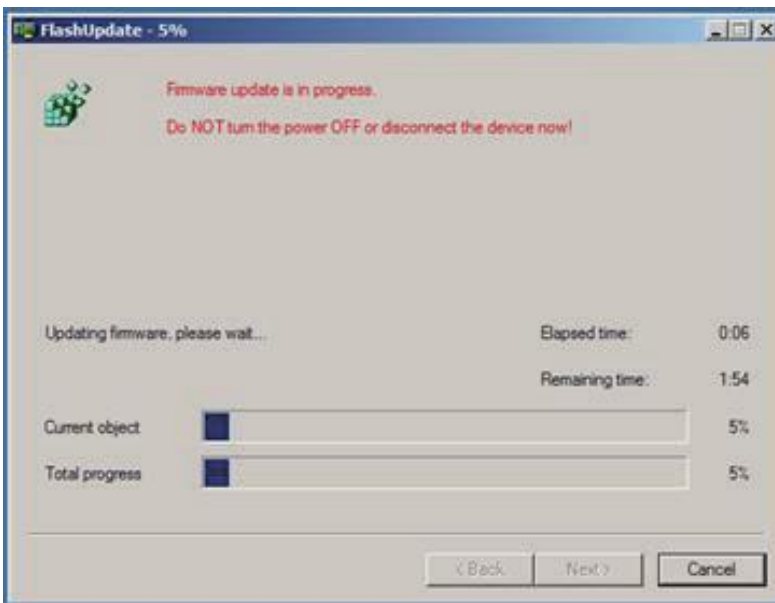

15. Reboot the switcher once the process is complete.

16. Check the output resolution and make sure it is at the desired 1080i standard.

17. Check the T-Bar and other functions and make sure they work properly.

T-Bar Re-Calibration

After a firmware update of the switcher it will be necessary to re-calibrate the T-Bar to get it working correctly.

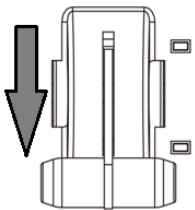
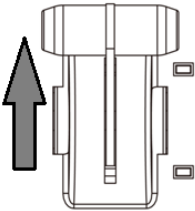
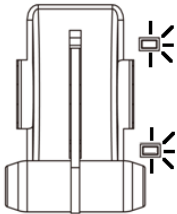
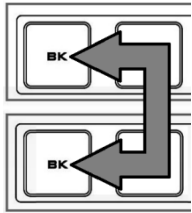
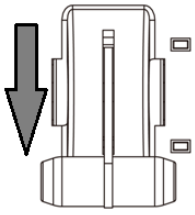

1. Move the T-Bar to its **lowest position**.
2. **Power OFF** the HS-2200 switcher.
3. Press and **hold down BK button on both the Program and Preset** rows of the switcher's keyboard.
4. **Power ON** the HS-2200 switcher while **still holding down the buttons** in step 3.
5. The switcher will start but the keyboard lights will remain dead except for the T-Bar progress LEDs. When these **LEDs flash ON and OFF** release the buttons from step 3.
6. Move the T-Bar to its **top position** and then press the **CUT button**.
7. Move the T-Bar **back to its lowest position** and then press the **AUTO TAKE button**.
8. To exit the calibration procedure, press the **CLOCK button**.
9. Ensure the **TIMER button** is **OFF**.
10. Test the T-Bar.
If necessary change the **T-Bar Mode** in the **OSD MENU options**.

Appendix 2 GPI Connections

The HS-2200 can control external recorder/playback devices like the HDR-60/70 via simple contact closure GPI switch.

The GPI interface is a 3.5mm Jack Socket which is situated on the rear panel of the HS-2200. Contact closure between the Outer and Inner contacts on the jack plug will trigger a user selected event. Power is supplied by the HS-2200 and is less than 5V DC.

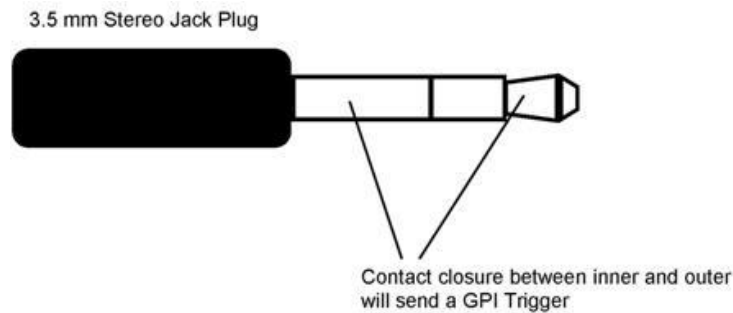

This GPI socket can also be used as a socket to trigger record or playback events with other equipment such as the Datavideo HDR-70 recorder.

SAFETY FIRST The cabling required needs to be designed specifically to connect the HS-2200 to the chosen record or playback device as they are not all the same. The cabling required can be made by yourself or a competent technician. Please speak with your Dealer or local Datavideo office to get further help and advice.

Appendix 3 Dimensions

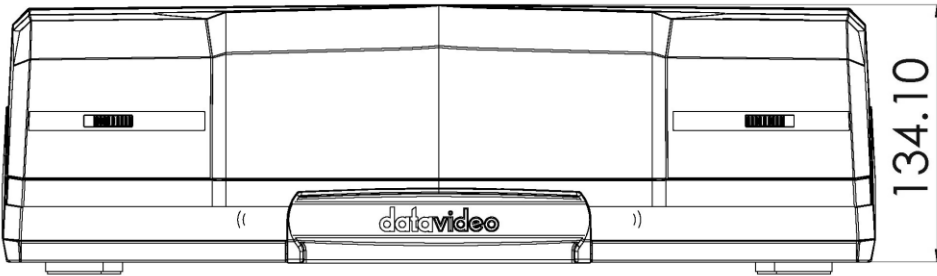
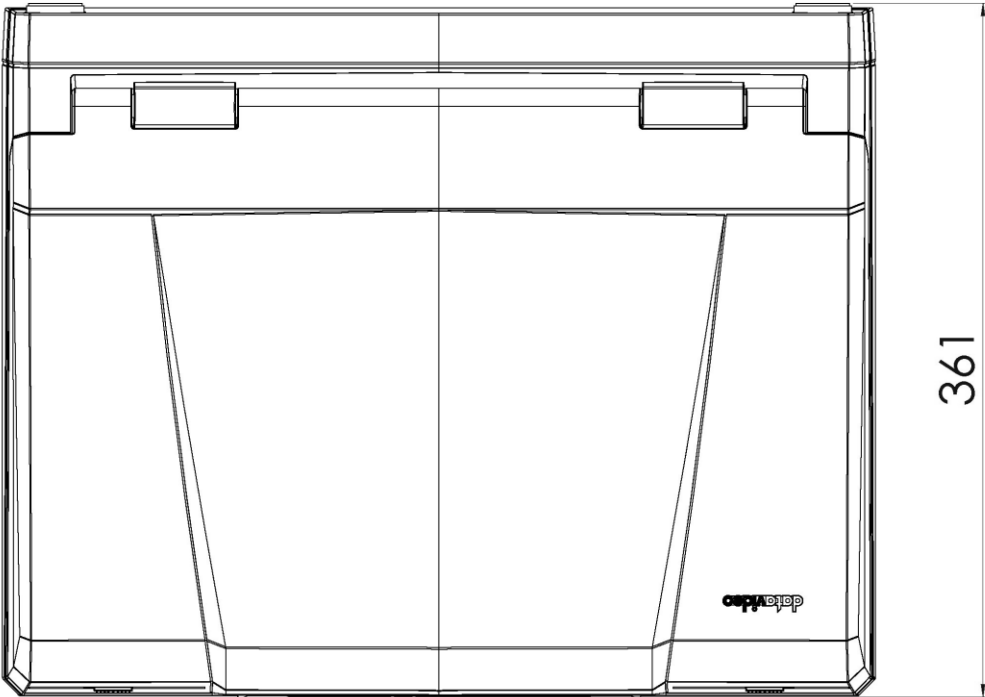
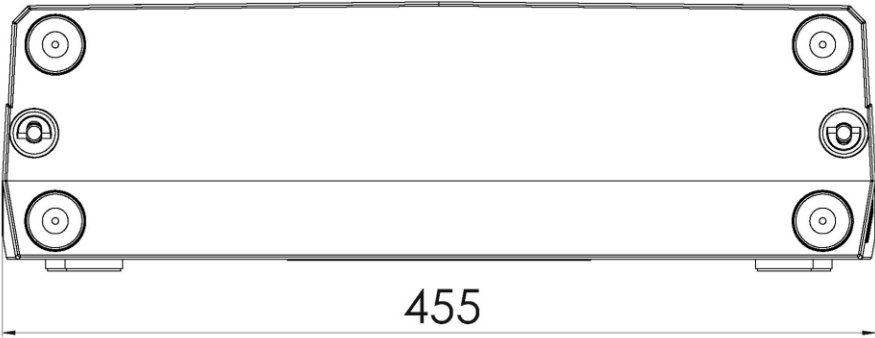

All measurements in millimetres (mm)

Appendix 4 Specifications

Model Name	HS-2200
Product Name	6-Channel HD/SD Mobile Cast Video Studio
Video Standard	HD & SD
Video Format	1080i 50/59.94/60Hz 720p 50/59.94/60Hz 576i 50Hz 480i 59.94Hz
Input Routable / Crosspoint	All 6, repeatable
Video Input	6 x HD-SDI 2 x HDMI (on CH 5/6)
Computer Graphical Interface	2 via HDMI
Down-Converted Output	N/A
Video Output	5 x SDI Outputs assignable: AUX 1 – 4 / PGM / PVW / PGM Clean / Multiview 1 x HDMI assignable: PGM / Multiview
Analogue Audio Input	4 x Balanced XLR
Analogue Audio Output	2 x Balanced XLR
Digital Embedded Audio Support	Input up to 16 Channels 4 Output Channels
Audio Delay Calibration	N/A
A+V Switching	Yes
USK	N/A
DSK	1 supporting Lumakey & Linear Key (Key/Fill)
Picture in Picture	2
Logo Insertion	2 (or 1 logo / 1 clock)
Title Creator	Yes, CG-200 is available for free
Built-in Audio Mixer	N/A
Built-in Monitor Display	17.3" HD TFT LED backlit, 1920x1080 pixels
Built-in Intercom & Tally	8 Channels (4 belt-packs incl.)
Special Features	Built-in TC-200 CG Interface 6x6 Matrix Seamless Switch
Weight	16.5 lbs (7.5 Kg), Reinforce Plastic Case
Power	DC 12V, 5A

Model Name	HS-2200
Product Name	6-Channel HD/SD Mobile Cast Video Studio
Operating Temperature	0 – 40°C
Accessory	CB-22H/23H/46/47/60/61/62

Service & Support

It is our goal to make owning and using Datavideo products a satisfying experience. Our support staff is available to assist you to set up and operate your system. Contact your local office for specific support requests. Plus, please visit www.datavideo.com to access our FAQ section.



Please visit our website for latest manual update.

www.datavideo.com/product/HS-2200

datavideo
www.datavideo.com



@DatavideoUSA @DatavideoIndia2016
@DatavideoEMEA @Datavideojapan
@DatavideoTaiwan @DatavideoLatam
@DatavideoAsia @DatavideoBrasil



@Datavideo
@Datavideo_EMEA
@Datavideo_Taiwan



@DatavideoUSA
@DVTWDCN



@DatavideoUSA
@DatavideoEurope

All the trademarks are the properties of their respective owners.
Datavideo Technologies Co., Ltd. All rights reserved 2020

Sep-08.2020
Version E8