

datavideo

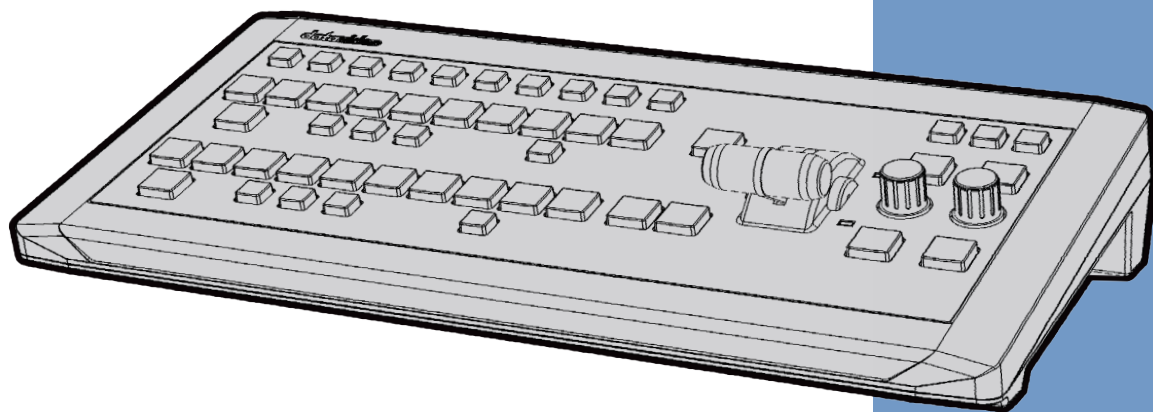

SE-1200MU
CONTROL UNIT
RMC-260
Instruction Manual

www.datavideo.com

Table of Contents

FCC COMPLIANCE STATEMENT	4
WARNINGS AND PRECAUTIONS	4
WARRANTY	5
STANDARD WARRANTY	5
THREE YEAR WARRANTY.....	5
DISPOSAL	6
1. PRODUCT OVERVIEW	6
1.1 FEATURES	6
2. OVERVIEW OF CONNECTIONS & CONTROLS	7
2.1 CONTROL PANEL OVERVIEW	7
2.2 REAR PANEL TERMINALS.....	7
3. KEYBOARD CONTROLS	9
3.1 USER MEMORY & WIPE TRANSITION COMBINATION KEYS	9
3.2 PROGRAM SOURCE ROW	10
3.3 PREVIEW SOURCE ROW	11
3.4 TRANSITION AND TRANSITION EFFECT.....	12
3.5 KEYER ASSIGNMENT AND ADJUSTMENT	14
4. OSD MENU	15
4.1 START	15
<i>Transition</i>	15
<i>Wipe Effects</i>	16
<i>Border</i>	16
<i>Position</i>	16
<i>Matte</i>	16
4.2 KEYER	16
<i>Keyer Control</i>	16
<i>Key Source</i>	17
<i>Fill Source</i>	17
<i>Mask</i>	17
4.3 CHROMA	17
<i>Keyer</i>	18
<i>CK Setup</i>	18
<i>Mask</i>	18
4.4 P-IN-P	18
<i>Position</i>	19
<i>Border</i>	19
<i>Border Width</i>	19
<i>Crop</i>	19
4.5 P-IN-P LITE	20
<i>Position</i>	20
<i>Border</i>	20
<i>Border Width</i>	20
<i>Crop</i>	20
4.6 INPUTS	20
<i>Input 1-4</i>	21
<i>Freeze</i>	21
<i>Crosspoint</i>	21
4.7 OUTPUTS.....	21
<i>Outputs</i>	22
<i>Audio</i>	22
<i>GPI Out</i>	23
<i>Multiviewer</i>	23

4.8	STILLS	23
	<i>Load Still</i>	24
	<i>Save Still</i>	24
	<i>Freeze</i>	24
4.9	USER MEMS.....	24
	<i>Load Memory</i>	25
	<i>Save Memory</i>	25
4.10	SETUP	25
	<i>Menu Preference</i>	25
	<i>Standard</i>	26
	<i>Menu Mode</i>	26
	<i>Auto Save</i>	26
	<i>Factory Default</i>	26
	<i>Reset Names</i>	26
	<i>Language</i>	26
	<i>Software</i>	26
5.	CONFIGURATION AND DEBUG MODE	27
5.1	ENTER CONFIGURATION AND DEBUG MODE	27
5.2	SELECTION OF CONFIGURATION AND DEBUG MODE FUNCTIONS.....	27
5.3	USER 1 – VERSION DISPLAY	28
5.4	USER 2 – LED BRIGHTNESS ADJUSTMENT AND MEMORY	29
5.5	USER 3 – BUTTON FUNCTIONAL CHECK	29
5.6	USER 4 – T-BAR AND KNOB FUNCTIONAL CHECK	29
5.7	USER 5 – EXIT CONFIGURATION AND DEBUG MODE	30
6.	RS-232 PIN DEFINITION	31
6.1	DEVICE PORT.....	31
6.2	CABLE CONNECTORS	31
7.	FIRMWARE UPDATE	32
8.	FREQUENTLY-ASKED QUESTIONS	33
9.	DIMENSIONS	34
10.	SPECIFICATIONS	34
	SERVICE AND SUPPORT	35

Disclaimer of Product and Services

The information offered in this instruction manual is intended as a guide only. At all times, Datavideo Technologies will try to give correct, complete and suitable information. However, Datavideo Technologies cannot exclude that some information in this manual, from time to time, may not be correct or may be incomplete. This manual may contain typing errors, omissions or incorrect information. Datavideo Technologies always recommend that you double check the information in this document for accuracy before making any purchase decision or using the product. Datavideo Technologies is not responsible for any omissions or errors, or for any subsequent loss or damage caused by using the information contained within this manual. Further advice on the content of this manual or on the product can be obtained by contacting your local Datavideo Office or dealer.

FCC Compliance Statement

This device complies with part 15 of the FCC rules. Operation is subject to the following two conditions:

1. This device may not cause harmful interference, and
2. This device must accept any interference received, including interference that may cause undesired operation.

Warnings and Precautions

1. Read all of these warnings and save them for later reference.
2. Follow all warnings and instructions marked on this unit.
3. Unplug this unit from the wall outlet before cleaning. Do not use liquid or aerosol cleaners. Use a damp cloth for cleaning.
4. Do not use this unit in or near water.
5. Do not place this unit on an unstable cart, stand, or table. The unit may fall, causing serious damage.
6. Slots and openings on the cabinet top, back, and bottom are provided for ventilation. To ensure safe and reliable operation of this unit, and to protect it from overheating, do not block or cover these openings. Do not place this unit on a bed, sofa, rug, or similar surface, as the ventilation openings on the bottom of the cabinet will be blocked. This unit should never be placed near or over a heat register or radiator. This unit should not be placed in a built-in installation unless proper ventilation is provided.
7. This product should only be operated from the type of power source indicated on the marking label of the AC adapter. If you are not sure of the type of power available, consult your Datavideo dealer or your local power company.
8. Do not allow anything to rest on the power cord. Do not locate this unit where the power cord will be walked on, rolled over, or otherwise stressed.
9. If an extension cord must be used with this unit, make sure that the total of the ampere ratings on the products plugged into the extension cord do not exceed the extension cord rating.
10. Make sure that the total amperes of all the units that are plugged into a single wall outlet do not exceed 15 amperes.
11. Never push objects of any kind into this unit through the cabinet ventilation slots, as they may touch dangerous voltage points or short out parts that could result in risk of fire or electric shock. Never spill liquid of any kind onto or into this unit.
12. Except as specifically explained elsewhere in this manual, do not attempt to service this product yourself. Opening or removing covers that are marked "Do Not Remove" may expose you to dangerous voltage points or other risks, and will void your warranty. Refer all service issues to qualified service personnel.
13. Unplug this product from the wall outlet and refer to qualified service personnel under the following conditions:
 - a. When the power cord is damaged or frayed;
 - b. When liquid has spilled into the unit;
 - c. When the product has been exposed to rain or water;
 - d. When the product does not operate normally under normal operating conditions. Adjust only those controls that are covered by the operating instructions in this manual; improper



- adjustment of other controls may result in damage to the unit and may often require extensive work by a qualified technician to restore the unit to normal operation;
- e. When the product has been dropped or the cabinet has been damaged;
 - f. When the product exhibits a distinct change in performance, indicating a need for service.

Warranty

Standard Warranty

- Datavideo equipment are guaranteed against any manufacturing defects for one year from the date of purchase.
- The original purchase invoice or other documentary evidence should be supplied at the time of any request for repair under warranty.
- The product warranty period begins on the purchase date. If the purchase date is unknown, the product warranty period begins on the thirtieth day after shipment from a Datavideo office.
- All non-Datavideo manufactured products (product without Datavideo logo) have only one year warranty from the date of purchase.
- Damage caused by accident, misuse, unauthorized repairs, sand, grit or water is not covered under warranty.
- Viruses and malware infections on the computer systems are not covered under warranty.
- Any errors that are caused by unauthorized third-party software installations, which are not required by our computer systems, are not covered under warranty.
- All mail or transportation costs including insurance are at the expense of the owner.
- All other claims of any nature are not covered.
- All accessories including headphones, cables, and batteries are not covered under warranty.
- Warranty only valid in the country or region of purchase.
- Your statutory rights are not affected.

Three Year Warranty

- All Datavideo products purchased after July 1st, 2017 are qualified for a free two years extension to the standard warranty, providing the product is registered with Datavideo within 30 days of purchase.
- Certain parts with limited lifetime expectancy such as LCD panels, DVD drives, Hard Drive, Solid State Drive, SD Card, USB Thumb Drive, Lighting, Camera module, PCIe Card are covered for 1 year.
- The three-year warranty must be registered on Datavideo's official website or with your local Datavideo office or one of its authorized distributors within 30 days of purchase.



Disposal



For EU Customers only - WEEE Marking

This symbol on the product or on its packaging indicates that this product must not be disposed of with your other household waste. Instead, it is your responsibility to dispose of your waste equipment by handing it over to a designated collection point for the recycling of waste electrical and electronic equipment. The separate collection and recycling of your waste equipment at the time of disposal will help to conserve natural resources and ensure that it is recycled in a manner that protects human health and the environment. For more information about where you can drop off your waste equipment for recycling, please contact your local city office, your household waste disposal service or the shop where you purchased the product.



CE Marking is the symbol as shown on the left of this page. The letters "CE" are the abbreviation of French phrase "Conformité Européene" which literally means "European Conformity". The term initially used was "EC Mark" and it was officially replaced by "CE Marking" in the Directive 93/68/EEC in 1993. "CE Marking" is now used in all EU official documents.

1. Product Overview

The RMC-260 is a cost effective controller designed specifically for the SE-1200MU Digital Video Switcher. The RMC-260 interfaces with the SE-1200MU via an RS-232 interface.

The RMC-260 is designed to be a user switcher-style controller to allow easy & quick control SE-1200MU, with hard keys for the main switcher functions and on-screen menu controls for quick & easy adjustment of parameters in the field.

The RMC-260 can be used with or without the PC Control Software, although the PC Control software must still be used for Software Upgrades and Import/Export of UserMems, Stills, and Clips.

That's Datavideo, sharing the value!

1.1 Features

- A switcher style keyboard for SE-1200MU operation
- Clear key definitions
- Support Keyers enable and quick function assignment
- Save user behaviour to user memory keys for quick access
- Two keyers with two corresponding knobs for assignment of Keyer 1/2 sources
- XPT (Cross Point Assignment)
- Take button to switch between PVW and PGM views
- FTB button fades the PGM view to a black screen
- Still Grab function for capturing instantaneous video image
- RS-232 interface for communication between RMC-260 and SE-1200MU
- Bright LED lighting

2. Overview of Connections & Controls

2.1 Control Panel Overview

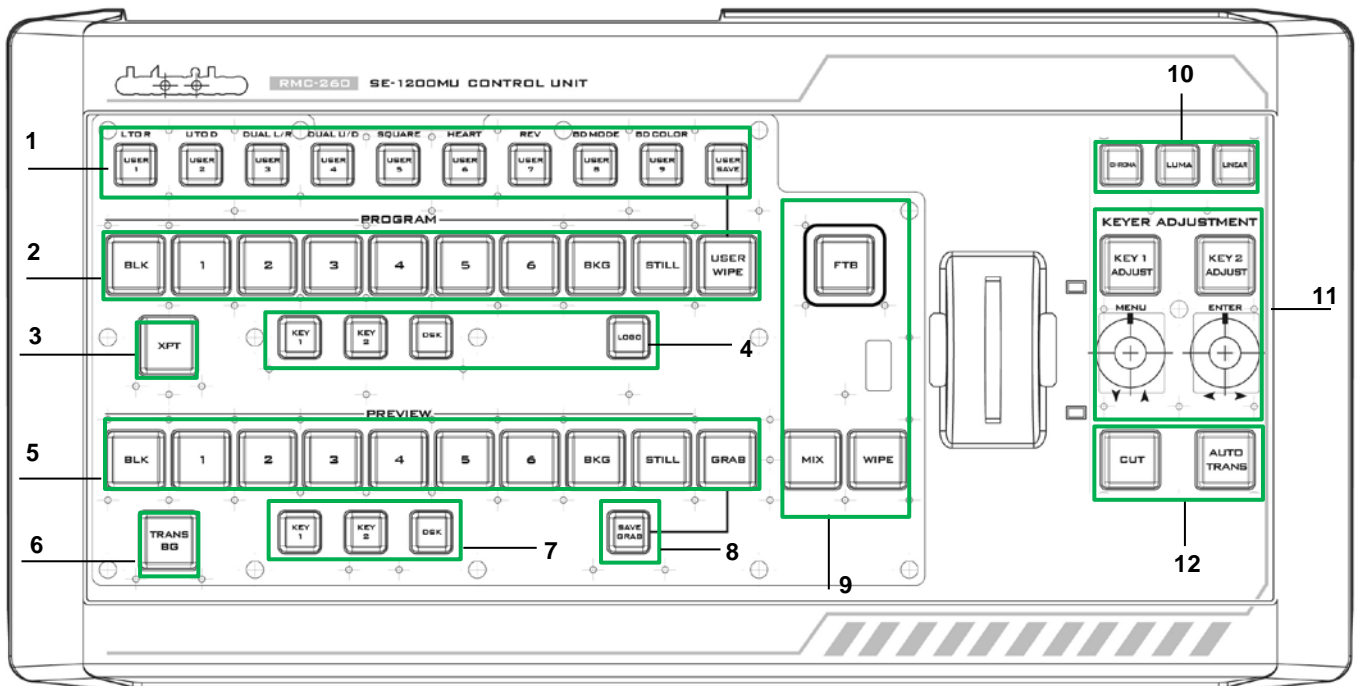

1	User Memory & WIPE Transition Selection	7	Keys / DSK Function on PVW
2	Program Source Row	8	Save Grab Image
3	XPT Cross-Point Function	9	Transition Effect
4	Keys / DSK Function on PGM	10	Keyer Assignment Button Row
5	Preview Source Row	11	Keyer Adjustment / Menu Control
6	Background Transition	12	Transition

2.2 Rear Panel Terminals

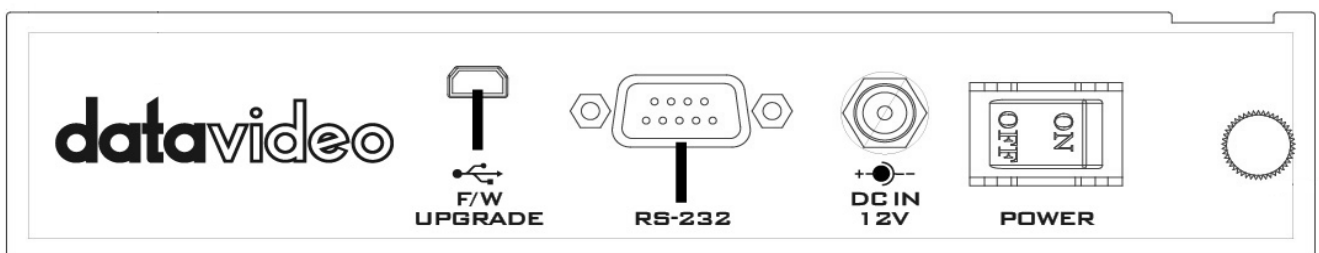

POWER

Power ON/OFF Switch

Switches the power ON/OFF.



DC In Socket

Connect the supplied 12V PSU to this socket. The connection can be secured by screwing the outer fastening ring of the DC-IN plug to the socket.



USB Firmware Upgrade

For connection to PC during the firmware upgrade process.

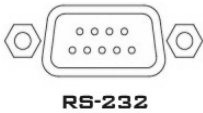

RS-232 Interface

RS-232 interface for communication between RMC-260 and SE-1200MU. Please refer to the [RS-232 PIN Definition](#) section for details.

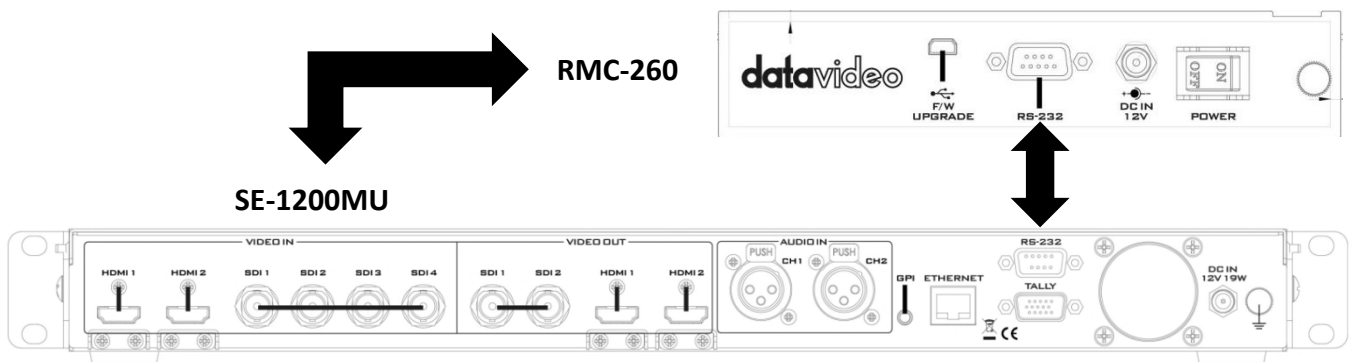

Note: As soon as the RS-232 connection is established, buttons will be lit in its corresponding functional color. After the RS-232 cable is disconnected, all button LEDs will turn white after a few seconds.

3. Keyboard Controls

3.1 User Memory & WIPE Transition Combination Keys

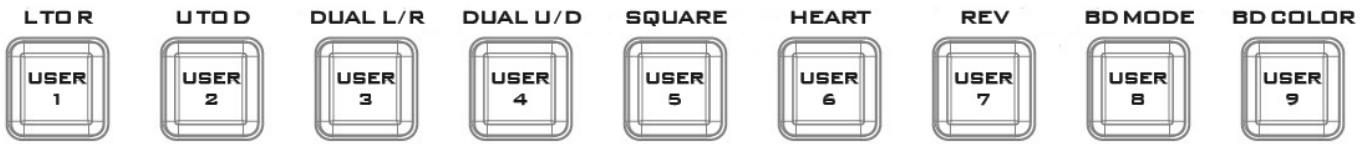

User Memory buttons 1-9: The User buttons are a shortcut way of loading previously saved user configurations, thus allowing the user to recall the last saved switcher settings.



USER SAVE

Pressing this button allows selection of the User Memory number from the User Memory button row for saving user defined settings.

After the **USER SAVE** button is pressed, the **USER SAVE** button LED will be turned on and the **USER 1-9** buttons will start flashing. Pick and press one USER button, all other USER buttons will be turned off except the selected USER button (**USER SAVE** button will remain ON). After the User settings are saved successfully, the selected USER button and the **USER SAVE** button will be turned off.

When the **USER SAVE** button and the **USER WIPE** button are OFF, the user defined settings may be recalled by pressing one of the USER buttons from the USER memory button row.

When the **USER SAVE** button and the **USER WIPE** button are ON at the same, the **USER SAVE** button will take precedence over the **USER WIPE** button.

WIPE Transition Selection: There are a total of 6 wipe transition types with details of each described in the table below.



L T O R

Wipe from left to right.



DUAL U/D

Wipe from Top and Bottom to Centre.



U T O D

Wipe from top to bottom.



SQUARE

SQUARE

Box Wipe from Centre to outside edges.



DUAL L/R

Wipe from Left and Right sides to Centre.

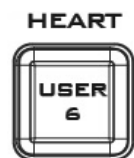

HEART

HEART

Heart Wipe from Centre to outside edges.



REV

When the REV button is ON then the selected transition will operate in the reverse direction only.

After the desired WIPE transition effect is selected, the user may turn on the WIPE border by pressing the **BD MODE** button and apply the border color by pressing the **BD COLOR** button.



BD MODE

Border width increment / decrement



BD COLOR

Optional color border applied

3.2 Program Source Row

The Program row of buttons is for control of the program output, which is the live output. You can switch or CUT from one video source to another directly on the Program row. You will see the PGM output changes as you press different keys along this top row of buttons.



Buttons 1, 2, 3, 4, 5 and 6: Video source buttons.

BLK button: Black background for use on the Program row.

BKG button: Background button that assigns a background color or color bars for use on the Program row.

STILL button: Press this button to cycle through Live Video, Freeze and Still.

USER WIPE: Press this button to swap between User Memory function and WIPE transition function. WIPE is enabled after **USER WIPE** button is ON. When the **USER SAVE** button and the **USER WIPE** button are ON at the same time, the **USER SAVE** button will take precedence over the **USER WIPE** button.

STILL: Press to cycle through Live Video/Freeze/Still of PGM

Note: If you are not sure what you are seeing is Freeze or Still, please enable the Multiview label info.



PGM XPT

Video source and channel assignments in accordance with the user's preference.

1. First press the **XPT** button. Buttons of Program and Preview rows will flash.
2. Press an output button on the Program row and the selected output button will turn red.
3. Press an input button on the Preview row and the selected input button will turn green.
4. At this point, the selected input on the Preview row is assigned to the corresponding output on the Program row.
5. The user may continue the assignment by pressing another output button on the program row or press the **XPT** button to complete the assignment.



PGM KEY 1
Enable / Disable Keyer 1



PGM KEY 2
Enable / Disable Keyer 2



PGM DSK
Pressing **DSK** places logo or animations on the program view. Before placing the DSK on the program view, make sure it is correct on the PVW screen first.

Note: DSK transition can only be executed using the CUT and AUTO buttons; T-BAR cannot be used for DSK transition.



PGM LOGO
Display of pre-selected logo on the Preview and Program outputs

3.3 Preview Source Row

The Preview row of buttons is for control of the Preview window. The Preview row sets the next transitioned program by pressing the corresponding key to select the source.



Buttons 1, 2, 3, 4, 5 and 6: Video source buttons.

BLK button: Black background for use on the Preview row.

BKG button: Background button that assigns a background color or color bars for use on the Preview row.

STILL button: Press this button to cycle through Live Video, Freeze and Still.

Note: If you are not sure what you are seeing is Freeze or Still, please enable the Multiview label info.

GRAB button: Pressing the **GRAB** button will capture a frame of video.



PVW TRANS BG

Background transition, **TRANS BG** specifies that the Background will be “transitioned” from the Program source to the Preview Source.



PVW KEY 1

Press to Enable / Disable Keyer 1 on Multiview and PVW Output or display keyer type.

Press and hold this button allows the user to select the desired keyer function from the KEYER ASSIGNMENT ROW (labelled number 10 in the Control Panel Overview section). As soon as Chroma/Luma/Linear buttons flash, press the corresponding button once to select the desired keyer.



PVW KEY 2

Press to Enable / Disable Keyer 2 on Multiview and PVW Output or display keyer type.

Press and hold this button allows the user to select the desired keyer function from the KEYER ASSIGNMENT ROW (labelled number 10 in the Control Panel Overview section). As soon as Chroma/Luma/Linear buttons flash, press the corresponding button once to select the desired keyer.



PVW DSK

Enable / Disable DSK on Multiview and PVW Output.

Press and hold this button allows the user to select the desired keyer function from the KEYER ASSIGNMENT ROW (labelled number 10 in the Control Panel Overview section). As soon as Chroma/Luma/Linear buttons flash, press the corresponding button once to select the desired keyer.

Note: DSK transition can only be executed using the CUT and AUTO buttons; T-BAR cannot be used for DSK transition.



SAVE GRAB

Pressing the **SAVE GRAB** button to save the grabbed picture to storage media

3.4 Transition and Transition Effect

The Transition Control controls what the “next” transition (mix, wipe, cut, Auto TRANS or the T-bar) will do, i.e. they specify what is “in the transition.”

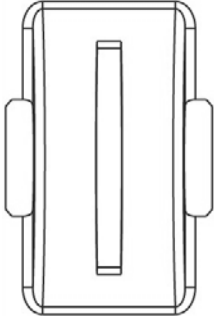

T-Bar

This performs a manually controlled transition from the current program source to the selected Preview source. When the **T-Bar** has travelled as far as it can go, the transition between sources is complete.



CUT Button

The **CUT** button is used to instantaneously switch between the currently selected Program and a Preview source.



AUTO TRANS Button

Instead of using the manually operated **T-Bar**, the **Auto TRANS** button is used to automatically transition between the selected Program and a Preview source over a set period.

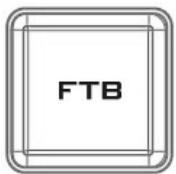

FTB

Fade To Black, this button fades the current video program source to black. When pressed again it acts in reverse from complete black to the currently selected program video source.



MIX Button

The **MIX** button is selected when a dissolve transition between the selected Program and a Preview source is required. This **Mix** transition is generated by moving the **T-Bar** manually or Pressing the **Auto TRANS** button.



WIPE Button

The **WIPE** button is selected when a wipe effect transition between the selected Program and a Preview source is required. This WIPE effect is generated by moving the **T-Bar** manually or by pressing the **Auto** button.

Clip transition mode is activated when **MIX/WIPE** buttons are enabled simultaneously.

3.5 Keyer Assignment and Adjustment



CHROMA

Press to select Chroma Keyer



LUMA

Press to select Luma Keyer



LINEAR

Press to select Linear Keyer

KEYER ADJUSTMENT



KEYER ADJUSTMENT

Press **KEY 1/2 ADJUST** buttons to activate the adjustment of the keyer type assigned to **KEY 1/2**. The knob is designed for the user to fine-tune the keyer.

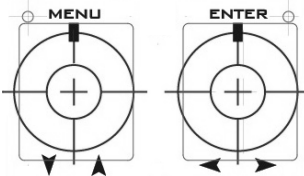

OSD MENU

- Press the left knob (MENU label) to open the OSD menu.
- To browse through the menu, simply rotate the left knob to move up/down the Main Menu Options
- Press the right knob (ENTER label) to select an option on the Menu and rotate the right knob to move left/right across the Sub-Menu Options.
- Press the right knob (ENTER label) to select a Sub-Menu Option and rotate the right knob to adjust the parameter values.
- To exit a particular sub-menu option, press the left knob.

Note: Refer to [OSD MENU](#) section for in-depth menu functional description.

MENU RESET

Long-pressing the menu knob for 2-3 seconds resets the MENU to their factory defaults.

4. OSD MENU

The SE-1200MU Control Unit (RMC-260) offers the user an OSD menu to perform several image effect configurations, such as Picture-in-Picture, keyers, downstream keys, still pictures and etc. The user can also configure the I/O by selecting the Inputs and Outputs options. In addition, under the setup options, the user is allowed to set the menu color, size, position and language.

The OSD Menu also gives the user the flexibility to switch between basic and advanced modes. The basic mode is generally a condensed version of the advanced menu mode. The following sections will show you the options available in these two modes.

4.1 Start

The “Start” option generally allows the user to set the Transition duration, the Transition type, and various WIPE effect parameters. The OSD menu display is illustrated in the table below.

Advanced Mode

Start	Transition	M/E 60	DSK 60	FTB 60
Keyer	Type	Wipe		
Chroma				
P-in-P	Wipe Effects	Wipe 1	Soft 0%	Width 0%
P-in-P Lite	Border	Luma 100%	Sat 80%	Hue 178
Inputs	Position	X 0%	Y 0%	
Outputs				
Stills	Matte	Luma 100%	Sat 80%	Hue 0
User Mems				
Setup				

Basic Mode

Start	Transition	M/E 60	DSK 60	FTB 60
Keyer				
Chroma	Wipe Effects	Wipe 1	Soft 0%	Width 0%
P-in-P				
P-in-P Lite				
Inputs				
Outputs				
Stills				
User Mems				
Setup				

Transition

The transition option allows the user to set the transition duration, in frames, for switching to the PGM view when using the **AUTO**, **DSK** and **FTB** buttons. The sub-options are (AUTO) Mix Effect (**M/E**), Downstream Key (**DSK**) and Fade-To-Black (**FTB**). If the M/E is set to a value of 50 then the transition will take effect over a period of 50 frames or roughly 2 seconds. When the **AUTO button** is pressed, the transition will take the current M/E value.

The three available transition types (**Type**) are **Clip/Wipe/Mix**.

Note: DSK transition can only be executed using the CUT and AUTO buttons; T-BAR cannot be used for DSK transition.

Wipe Effects

This sub-option allows the user to select the desired Wipe Transition Effect and configure the wipe’s border softness and width.

- **Wipe** – Wipe Effect Selection.
- **Soft** – A low value results in a solid edge border and a high value gives a soft diffused border.
- **Width** – A low value results in a thin border and a high value gives a wide border.

Border

After selecting this sub-option, the user will then be allowed to fine-tune the border color by adjusting the Luma, Saturation and Hue values, i.e. Luma, Sat and Hue.

Position

Position allows the user to adjust the centre position of some wipes (e.g Circle & Elipse). X represents the horizontal position and Y represents the vertical position.

X	Y
Positive value: position the wipe centre to the right Negative value: position the wipe centre to the left Zero value: Position the wipe centre at the screen centre	Positive value: move the wipe centre up Negative value: move the wipe centre down Zero value: Position the wipe centre at the screen centre

Matte

The user can configure the Matte Luma, Saturation and Hue under this sub-option.

4.2 Keyer

In this option, the user is able to configure four keyers, which are **Key 1**, **Key 2**, **DSK 1** and **DSK 2**.

Advanced Mode = Basic Mode

Start	Keyer	Key 1		
Keyer				
Chroma	Keyer Ctrl	Chroma	P-in-P	Priority Bot
P-in-P		Lift 0%	Gain 1.0	Opac 100%
P-in-P Lite	Key Source	Input 1	Fill Input 3	
Inputs				
Outputs	Mask	Left 0%	Right 0%	
Stills		Top 0%	Bot 0%	
User Mems				
Setup				

Keyer Control

There are three keying modes available: **Linear**, **Luma**, and **Chroma**.

After the keying mode is chosen, select **Self** if only one source is enabled for the keyer, which is **Key** source and select **Split** if two sources are enabled for the keyer, which are **Key** and **Fill** sources. You may also select **P-in-P** or **P-in-P Lite** to apply the keying effect to the P-in-P window.

Please note:

If Luma is selected, fine tune the Luma Keyer parameters (Lift, Gain and Opac) in the Keyer option.

If Chroma is selected, fine tune the Chroma Keyer parameters in the Chroma option.

If P-in-P is selected, fine tune its parameters in the P-in-P option.

If P-in-P Lite is selected, fine tune its parameters in the P-in-P Lite option.

For example, if the user selects **Key 1** → **Chroma** → **P-in-P**, you will be performing chromakeying of the P-in-P image after the corresponding chroma keyer parameters are adjusted in the **Chroma** option.

Priority sets the key image to either the top layer or bottom layer and is only available if **Key 1** or **Key 2** is selected.

The Keyer Control also allows the user to adjust lift, gain and opacity of the key image.

Lift adjusts the dark/black areas of the key image.

Gain adjusts the light/white areas of the key image.

Opacity adjusts the transparency of the overall foreground key image.

Key Source

This sub-option allows the user to assign the key source; various options are listed below:

Bars	Matte	Input6	Input5	Input4	Input3	Input2	Input1	Black
------	-------	--------	--------	--------	--------	--------	--------	-------

Fill Source

This sub-option allows the user to assign the fill source if **Split** is selected; various options are listed below:

Bars	Matte	Input6	Input5	Input4	Input3	Input2	Input1	Black
------	-------	--------	--------	--------	--------	--------	--------	-------

Mask

The Mask feature allows the user to configure the Mask in chroma, luma or linear mode.

- Left – Left sets the left edge of the keyer mask.
- Right – Right sets the right edge of the keyer mask.
- Top – Top sets the top edge of the keyer mask.
- Bottom – Bottom sets the bottom edge of the keyer mask.

4.3 Chroma

In this option, the user will be able to find all the parameters needed to perform chromakeying of the green backdrop.

Advanced Mode = Basic Mode

Start	Keyer	Key 1		
Keyer	Key Source	Input 5		
Chroma				

P-in-P	CK Setup	CK Auto	Hue	120	Luma	100%	
P-in-P Lite		KRange	170	K Fgnd	15%	K Bgnd	67%
Inputs		Hi-Light	0%	Lo-Light	0%	Bg-Supp	On
Outputs							
Stills	Mask	Left	0%	Right	0%		
User Memos		Top	0%	Bot	0%		
Setup							

Keyer

First of all, select the **Keyer** that you would like to enable for the chromakeyer (**Key 1**, or **Key 2**) and then select one Key Source from all available **Key Sources** listed in the table below.

Bars	Matte	Input6	Input5	Input4	Input3	Input2	Input1	Black
------	-------	--------	--------	--------	--------	--------	--------	-------

CK Setup

In this sub-option, the user will be able to fine tune various chroma keyer parameters.

CK Auto: This function calculates the best Hue & Luma values for the current Key Source.

Hue: This parameter adjusts the color of the chroma key. A typical green screen value will be around 120. Blue screen value will be around 240.

Luma: This parameter adjusts the luma value of the chroma key

Key Range (KRange): Key Range sets the range of hues or colors (0 – 360 degrees) that closely match the background color to be keyed. The user can start with a value of 120 degrees and this value can be fine-tuned up or down depending on the setup of the green or blue screen studio.

Key Foreground (K Fgnd): Key Foreground adjusts the performance of the chroma key in dark or black areas. Increase the value if the dark areas are becoming too transparent.

Key Background (K Bgnd): Key Background adjusts the performance of the chroma key in light or white areas. Increase the value if the light areas are becoming too transparent.

Hi-Light: Hi-light boosts the foreground key in high luminance area.

Lo-Light: Lo-light boosts the foreground key in low luminance area.

Bg-Supp: Background Suppress removes the Luma (Brightness) of the background from the final image. Bg-Supp turns ON/OFF background suppression.

Mask

The Mask feature allows the user to configure the Mask in chroma mode.

- Left – Left sets the left edge of the Chroma keyer mask.
- Right – Right sets the right edge of the Chroma keyer mask.
- Top – Top sets the top edge of the Chroma keyer mask.
- Bottom – Bottom sets the bottom edge of the Chroma keyer mask.

4.4 P-in-P

P-in-P option allows the user to adjust all related P-in-P parameters. Enter this option if the user selects **P-in-P** in the **Keyer** option. “**P-in-P Scr**” sub-option will indicate the keyer enabled for P-in-P. In our example below, the **Key 1** keying effect will be applied to the P-in-P window.

Please note that the “P-in-P Scr” sub-option can only be changed in the **Keyer** option.

Advanced Mode = Basic Mode

Start	P-in-P Src	Key 1			
Keyer	Position	X 20%	Y 10%	Size 50%	
Chroma	Border	Luma 0%	Sat 0%	Hue 0	
P-in-P		Width 0%			
P-in-P Lite					
Inputs	Crop	Left 0%	Right 0%	Size 0%	
Outputs		Top 0%	Bot 0%		
Stills					
User Mems					
Setup					

Position

The user can adjust the P-in-P window position by adjusting values of **X**, **Y** and **SIZE**, where X is the horizontal position, Y is the vertical position and Size is the P-in-P window size.

X	Y	Size
Positive value: position the P-in-P window to the right. Negative value: position the P-in-P window to the left. Zero value: Position the P-in-P window at the center.	Positive value: move the P-in-P window up. Negative value: move the P-in-P window down. Zero value: Position the P-in-P window at the center.	Ranges from 0 to 100 with 1% being the smallest and 100 being the largest. So 50% would represent a P-in-P window which is half the size of the background image. 100% would see the PIP image totally cover the background image unless offset to one side.

Border

P-in-P window border color can be set by adjusting the **Luma**, **Saturation** and **Hue** values.

Border Width

The “**Width**” sub-option adjusts the border width. A width of zero (0) will turn the P-in-P window border off.

Crop

The P-in-P window crop can be adjusted by modifying the following parameters:

- **Left** – Adjusts the position of the left edge of the P-in-P window.
- **Right** – Adjusts the position of the right edge of the P-in-P window.
- **Size** – Adjusts the P-in-P window crop size.
- **Top** – Adjusts the position of the top edge of the P-in-P window.
- **Bot** – Adjusts the position of the bottom edge of the P-in-P window.

4.5 P-in-P Lite

P-in-P Lite option allows the user to adjust related P-in-P parameters **EXCEPT** its vertical position and the P-in-P window size. Enter this option if the user selects **P-in-P Lite** in the **Keyer** option. “**P-in-P Keyer**” sub-option will indicate the keyer enabled for P-in-P Lite. In our example below, the **Key 1** keying effect will be applied to the P-in-P Lite window.

Please note that the “**P-in-P Keyer**” sub-option can only be changed in the **Keyer** option.

Advanced Mode = Basic Mode

Start	P-in-P Keyer	Key 1				
Keyer	Position	X	-22%			
Chroma	Border	Luma	100%	Sat	80%	Hue 0
P-in-P		Width	2%			
P-in-P Lite						
Inputs	Crop	Left	32%	Right	22%	Size 0%
Outputs		Top	2%	Bot	24%	
Stills						
User Memos						
Setup						

Position

The user can adjust the horizontal position of the P-in-P window by adjusting the **X** value.

- Positive X value positions the P-in-P window to the right.
- Negative X value positions the P-in-P window to the left.
- Zero X value positions the P-in-P window at the center.

Border

P-in-P window border color can be set by adjusting the **Luma**, **Saturation** and **Hue** values.

Border Width

The “**Width**” sub-option adjusts the border width. A width of zero (0) will turn the P-in-P window border off.

Crop

The P-in-P window crop can be adjusted by modifying the following parameters:

- **Left** – Adjusts the position of the left edge of the P-in-P window.
- **Right** – Adjusts the position of the right edge of the P-in-P window.
- **Size** – Adjusts the P-in-P window crop size.
- **Top** – Adjusts the position of the top edge of the P-in-P window.
- **Bot** – Adjusts the position of the bottom edge of the P-in-P window.

4.6 Inputs

This feature allows the user to configure the color of the Inputs 1-4. In addition, the user can shuffle the contents between Inputs 1-6 or turn off the input channel.

Advanced Mode

Start	Input 1	Black	0%	White	100%	Chrom	1.0
Keyer	Input 2	Black	0%	White	100%	Chrom	1.0
Chroma	Input 3	Black	0%	White	100%	Chrom	1.0
P-in-P	Input 4	Black	0%	White	100%	Chrom	1.0
P-in-P Lite							
Inputs	Freeze	1	Still	2	Live	3	Still
Outputs		4	Still	5	Still	6	Live
Stills							
User Mems	Crosspoint	1	Input 1	2	Input 2	3	Input 3
Setup		4	Input 4	5	Input 5	6	Input 6

Basic Mode

Start	Freeze	1	Still	2	Live	3	Still
Keyer		4	Still	5	Still	6	Live
Chroma							
P-in-P	Crosspoint	1	Input 1	2	Input 2	3	Input 3
P-in-P Lite		4	Input 4	5	Input 5	6	Input 6
Inputs							
Outputs							
Stills							
User Mems							
Setup							

Input 1-4

By selecting the corresponding input (Inputs 1-4), the user will then be allowed to configure the colour of the inputs 1-4 by adjusting its Black Level, White Clip and Chroma Gain parameters.

Freeze

“Freeze” allows the user to load an image to **Inputs 1-6** from one of the four sources listed as follows:

- **Clip**
- **Still**
- **Freeze**
- **Live**

Crosspoint

Crosspoint gives the user the ability to shuffle the contents between Inputs 1-6. In other words, the user will be able to assign any of the sources of Inputs 1-6 to the 6 input buttons (1, 2, 3, 4, 5 and 6) of the Program and Preset rows as desired.

4.7 Outputs

This option allows the user to configure various output settings such as video output, audio output, and GPI Out.

Advanced Mode

Start	Output	Sdi 1	Pgm	Sdi 2	Input 2	HDMI	MultiV
Keyer						HDMI	1080P
Chroma	Audio	Mode	On	Level	Auto		
P-in-P		Sdi 1	On	Sdi 2	On	HDMI	On

P-in-P Lite					
Inputs	GPI Out	Off	Mode	Pulse	Width 1
Outputs		Input 1	Delay	0	
Stills					
User Memos	MultiViewer	AutoNum	Off	Label Inf	Off Trns Lab Off
Setup					

Basic Mode

Start	Output	Sdi 1	Pgm	Sdi 2	Input 2	HDMI	MultiV
Keyer						HDMI	1080P
Chroma	Audio	Mode	On	Level	Auto		
P-in-P		Sdi 1	On	Sdi 2	On	HDMI	On
P-in-P Lite							
Inputs							
Outputs							
Stills							
User Memos							
Setup							

Outputs

In general, there are three output ports (**SDI 1**, **SDI 2** and **HDMI**) available, which can be configured to output one of the following:

- Input 6
- Input 5
- Input 4
- Input 3
- Input 2
- Input 1
- CLN PVW (Clean PVW)
- CLN PGM (Clean PGM)
- PG + DSK
- PVW
- PGM
- MultiV (Multi view)

In addition to selecting your output source, you are also allowed to set two different resolutions to the HDMI output port. The two available resolutions are 1080i and 1080p.

Please note that when HDMI OUT is set to 1080i, image will be enlarged on the DELL 24" monitor (Wide Mode = 1:1), exceeding the viewable screen area (overscan). In 1080p and 720p modes, image overscan and shifts are seen on BENQ 37"/SONY 42" TV.

Audio

The Audio sub-option for the SDI and HDMI outputs allows the user to individually turn ON/OFF the embedded audio component at the **SDI1-out**, **SDI2-out** and **HDMI-out**.

Mode (On/Off): The SE-1200MU can only accept external audio using the analogue XLR inputs on the rear panel. Ideally a master audio mixer would be used alongside the SE-1200MU. A Datavideo AM-100 or AD-200 could be considered. By changing the Audio sub option from ON to OFF will mute the incoming XLR audio from the external master audio mixer.

Level (EBU/SMPTE/AUTO): There are two different audio standards available for selection. The user can either select the EBU or SMPTE standard. By selecting AUTO allows the device to automatically detect the audio standard.

GPI Out

This allows the user to perform GPI configuration. After turning on the GPI, select the GPI **mode**, which is either level or pulse. The pulse width can also be configured in the sub-option **Width** (1-9). GPI out can then be assigned to one of Inputs 1-6 and the **delay** can be set to between 1 and 99. This feature could be used to trigger playback from an external playback device such as Datavideo’s NVP-20 or HRS-30 unit.

Multiviewer

AutoNum: The Multiview windows can be automatically numbered, and this sub-option turns ON/OFF automatic numbering.

Label Inf: This sub-option turns ON/OFF Label information. Input label is followed by information which describes the input as still, live or frozen image.

Trns Lab: This sub-option turns ON/OFF Label Transparency. Once enabled, the background of the label is then turned from a solid colour to transparent.

4.8 Stills

Still allows the user to load images from the memory, save images to the memory, and save the images captured.

Advanced Mode

Start	Load Still	Load	Still Num 13	Input 5
Keyer		Thumbnail Picture - 1	Thumbnail Picture	Thumbnail Picture + 1
Chroma				
P-in-P				
P-in-P Lite	Save Still	Save	Input 5	Still Num 13
Inputs				
Outputs	Freeze	1 Still	2 Live	3 Still
Stills		4 Still	5 Still	6 Live
User Mems				
Setup				

Basic Mode

Start	Load Still	Load	Still Num 13	Input 5
Keyer		Thumbnail Picture - 1	Thumbnail Picture	Thumbnail Picture + 1
Chroma				
P-in-P				
P-in-P Lite	Save Still	Save	Input 5	Still Num 13
Inputs				
Outputs				
Stills				
User Mems				
Setup				

Load Still

Upon selecting “Load Still”, the user can then choose the memory location from which the still image is loaded. The following are the destinations to which the still image can be loaded:

- Input 6
- Input 5
- Input 4
- Input 3
- Input 2
- Input 1

Select “Load” to load the still image to the determined destination.

Image Preview is available below the “Load Still” row. “**Image Preview – 1**” allows the user to preview the previous image, “**Image Preview**” displays the image that will be loaded when “**Load**” is selected, and “**Image Preview + 1**” shows the next image.

Save Still

“Save Still” allows the user to save the still image to a specific memory location. The user should determine the source of the still image first. The available sources are listed below:

- Input 6
- Input 5
- Input 4
- Input 3
- Input 2
- Input 1

To complete the save, the user can simply select “Save” after determining the memory location.

Freeze

“Freeze” allows the user to load an image to **Inputs 1-6** from one of the four sources listed as follows:

- Clip
- Still
- Freeze
- Live

4.9 User Mems

In this option, the user is allowed to **load** previously saved settings and **save** the currently configured settings.

Advanced Mode = Basic Mode

Start	Load Mem	Memory	1	Load	
Keyer					
Chroma	Save Mem	Memory	1	Save	
P-in-P					
P-in-P Lite					
Inputs					
Outputs					
Stills					
User Mems					
Setup					

Load Memory

Use the up/down arrow to scroll to the desired memory location (1-999) and load the saved setting by selecting "Load". The user can also press one of the USER memory shortcut buttons (USER 1-9) on the control panel as a quick way of loading those previously saved User configurations.

Save Memory

Use the up/down arrow to scroll to the desired memory location and save the current setting by selecting "Save"

4.10 Setup

In the "Setup" menu, the user can change the **resolution**, switch between full and simplified menu versions, adjust the **menu preferences**, enable/disable **Auto Save**, reset the machine to its **Factory Default** settings, choose the preferred OSD menu **language**, **upgrade firmware** and view the **current firmware versions** (Interface, Mainboard and Keyboard).

Start	Standard	1080i/59.94	Save Setup	
Keyer	Menu Mode	Advanced		
Chroma	Menu Pref	Blue	Transp	1 Size Normal
P-in-P	Menu Pos	Centre		
P-in-P Lite				
Inputs	Auto Save	On		
Outputs	Factory Def	Reset	Reset Names	
Stills	Language	English		
User Mem				
Setup		S/W: v1.2.2.8	F/W: 2016-03-15	KBD: v2.26

Menu Preference

In menu preference, the user is allowed to set the menu color, menu transparency level, menu size and the display position.

Menu color: the available colors are blue and grey

Options of **Menu Transparency** are listed below:

0: No Transparency

1: Background 50% Transparent (buttons not Transparent)

2: All Menu 50% Transparent

Menu Size

The menu size options are:

1. Normal

2. Small (1080i Mode)

3. Large (720p Mode)

Menu Position

Menu Position gives the user ability to select several positions for the Menu area on the Screen. The current options are Centre, Top, Left, Right and Bottom.

Standard

This option allows the user to choose the appropriate output resolution such as 1080i/50. Once done, simply select “**Save Setup**” to confirm the selected output resolution. The available resolutions are 1080i/50/59.94/60, 720p/60/59.94/50.

Menu Mode

The user is allowed to switch between full and simplified menu versions. Select “Advanced” for full menu display or “Basic” to display a simplified version of the OSD menu.

Auto Save

When enabled, your last settings will be automatically saved before the machine is shut down. At the next boot, the machine will automatically load the last saved settings. In addition, a Still Load will cause the auto save to occur.

Factory Default

Reset: This option resets the machine to the factory default settings by loading the default configuration from memory point 0 for all configuration options except for the **Setup**.

Reset Names

This resets the Multiviewer labels (Inputs 1-6) to their default settings.

Language

The available languages for OSD menu are English, Traditional Chinese and Simplified Chinese.

Software

This option is only available when the USB storage device containing the latest firmware file is inserted. Select Upgrade to start the firmware upgrade process. Refer to the [FIRMWARE UPDATE](#) section for more details.

At the bottom of the menu, you will be able to view the version number of the latest firmware installed.

5. Configuration and Debug Mode

5.1 Enter Configuration and Debug Mode

While SE-1200MU is not connected (all button LEDs are white), simultaneously press **USER 1** and **USER SAVE** buttons and all button LEDs will flash; wait till all buttons return to white color and once the **USER 1** button turns red, the device is in the Configuration and Debug Mode.

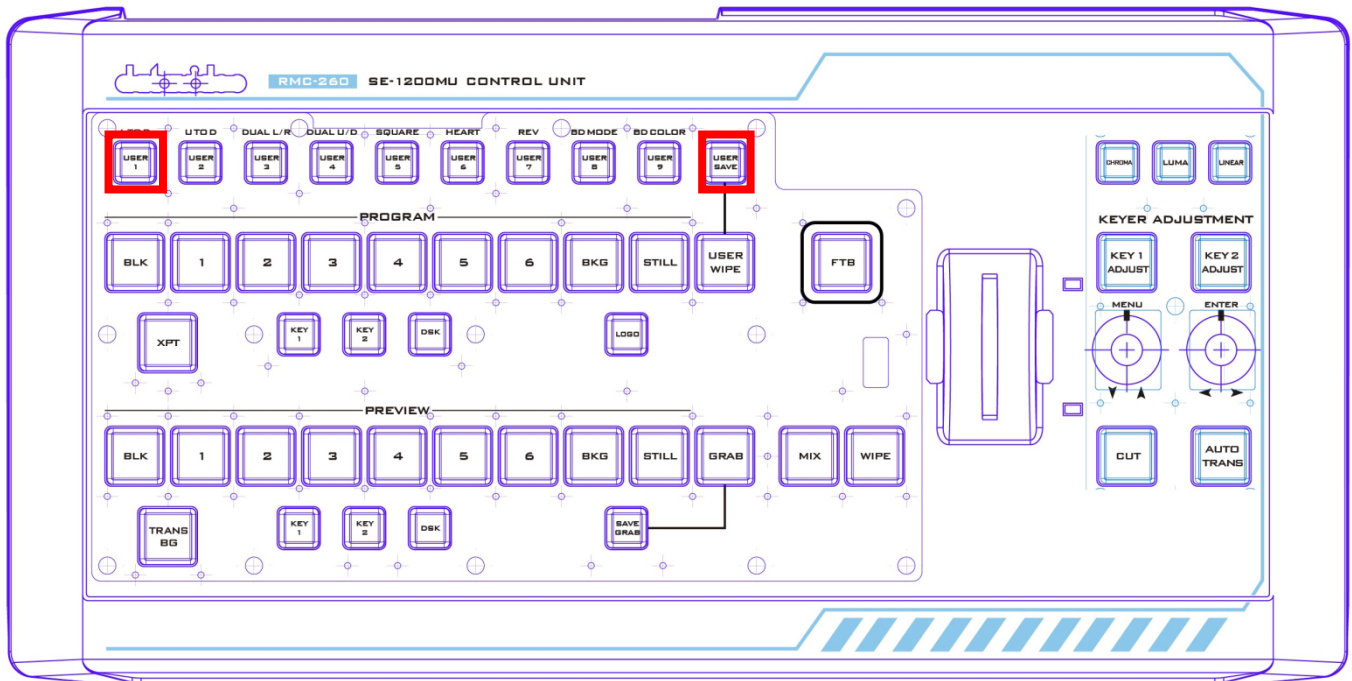

5.2 Selection of Configuration and Debug Mode Functions

Rotate the **MENU** knob below the **KEY1 ADJUST** button to cycle through **USER 1-5** (F1-F5) and as you rotate the **MENU** knob, you will see the **USER 1-5** buttons turn red one at a time.

To enter a particular menu function, simply press the **MENU** knob.

To exit, press the **MENU** knob again.

The available functions are listed as follows:

- USER 1** – Version information display
- USER 2** – LED brightness adjustment and memory
- USER 3** – Button functional check
- USER 4** – T-Bar and knob functional check
- USER 5** – Exit configuration and debug mode

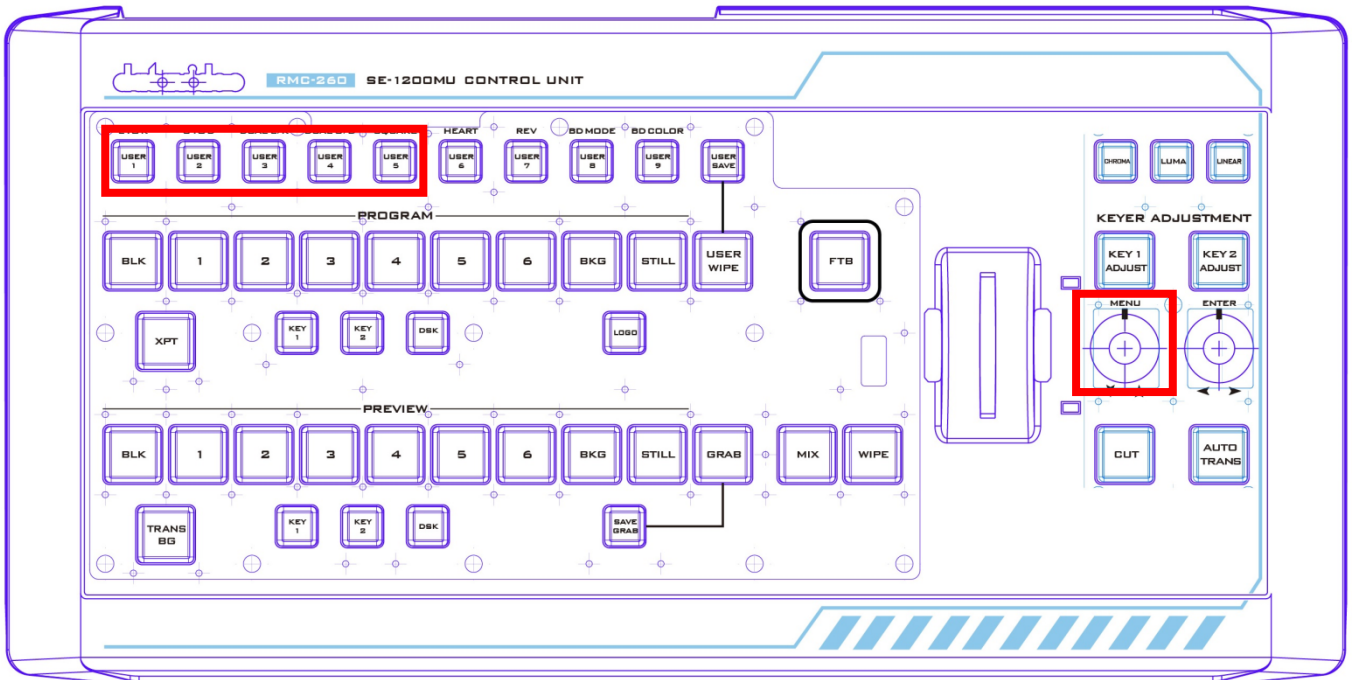

5.3 USER 1 – Version Display

Once the **USER 1** button is selected after pressing the **MENU** knob, the user will immediately see some buttons on the **PROGRAM** row turn red and some buttons on the **PREVIEW** row turn green, which represent the current firmware version loaded on the device.

VERSION is displayed in HEX format. PROGRAM row indicates Major version digits, and PRESET row indicates Minor version digits. **BLK** is the most significant bit and **BKG** is the least significant bit.

Bit 7	Bit 6	Bit 5	Bit 4	Bit 3	Bit 2	Bit 1	Bit 0
BLK	1	2	3	4	5	6	BKG

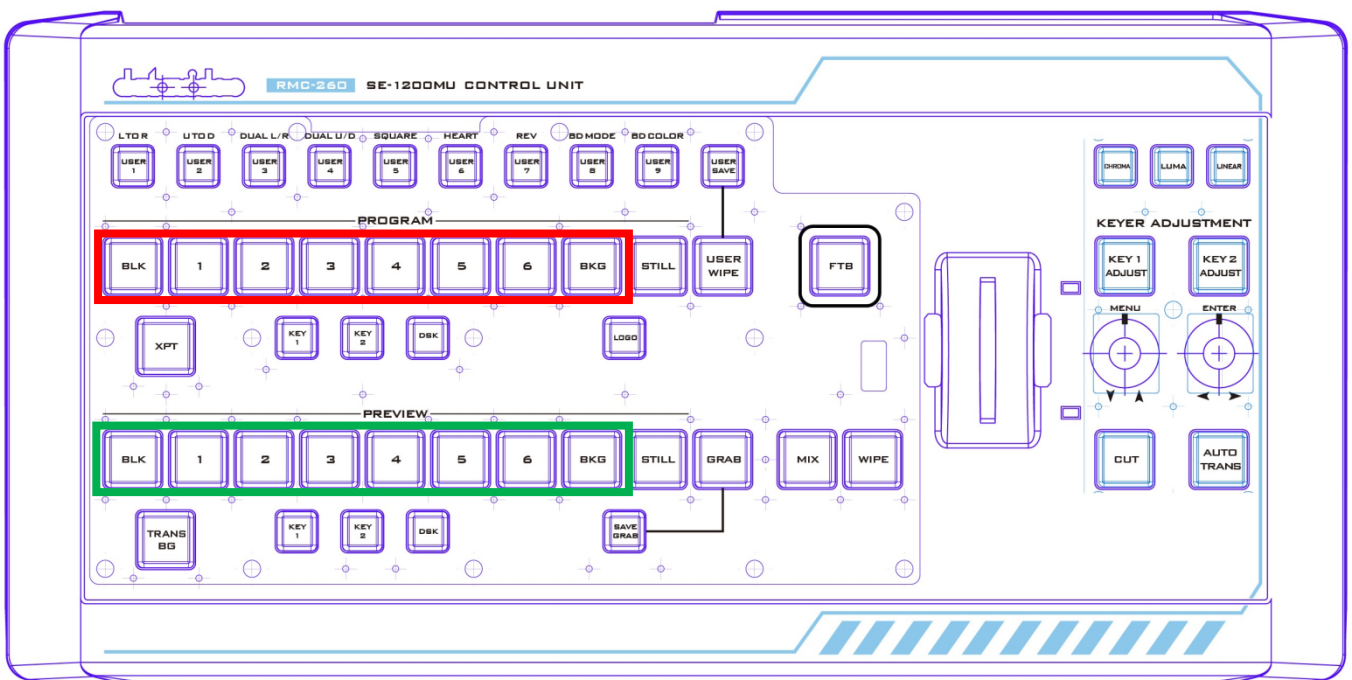

5.4 USER 2 – LED Brightness Adjustment and Memory

To adjust the button LED brightness, simply press the MENU knob to select **USER 2** button. Immediately after the **USER 2** button is selected, the user will see some or all of buttons BLK/1/2/3/4 turn red along the PROGRAM row depending on the previous brightness setting.

- **MENU Knob** – Rotate left and right to adjust the LED brightness
- **ENTER Knob** – Press to save the current brightness setting and upon the knob press, **KEY 2 ADJUST** button will start flashing red. After the new setting is saved, **KEY 2 ADJUST** button will remain constant red.
- **DSK 2 Button** – Flashing red indicates the SAVE is in progress and constant red indicates that brightness level is successfully saved.
- **Buttons BLK/1/2/3/4** along the PROGRAM row indicate the current LED brightness level.

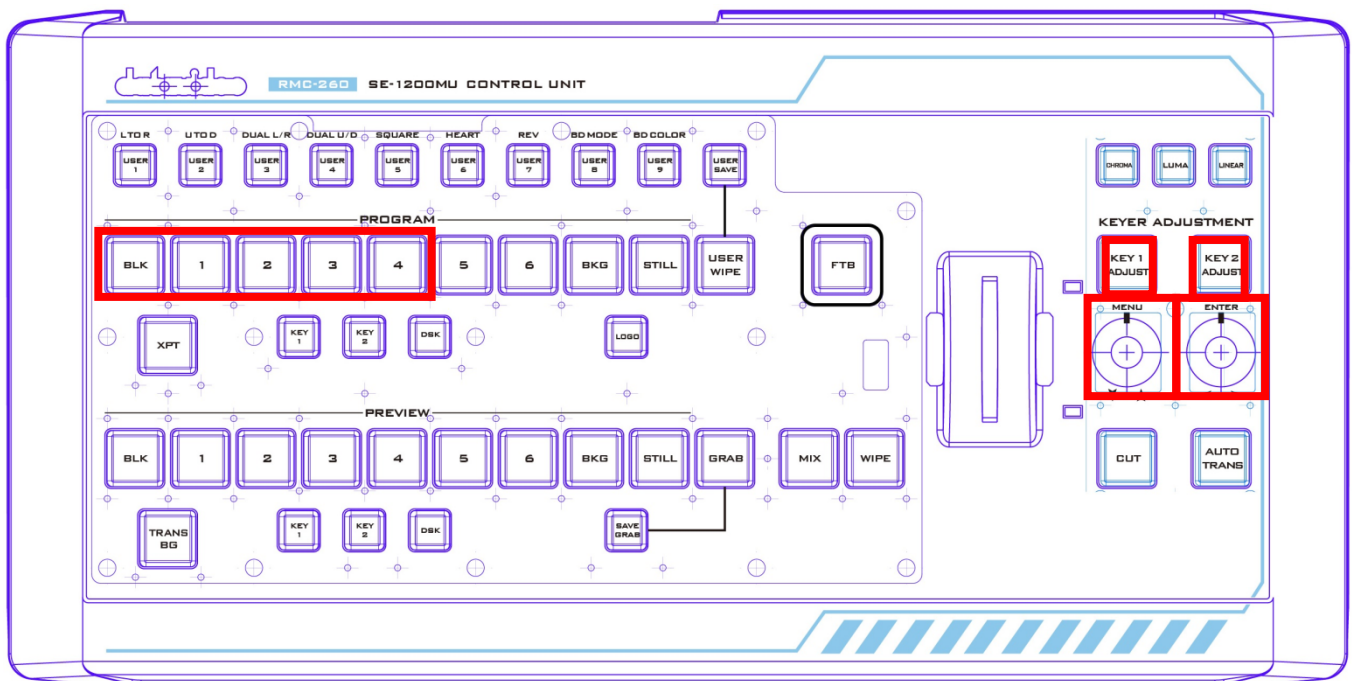

5.5 USER 3 – Button Functional Check

Press the **MENU** knob to select **USER 3** button to perform button functional check and press the **MENU** knob to exit.

5.6 USER 4 – T-Bar and Knob Functional Check

Press the **MENU** knob to select **USER 4** button to perform T-Bar and knob functional check.

PROGRAM row (**BLK/1/2/3/4/5/6/BKG/STILL/USER WIPE**) indicates **T-Bar** position, so moving **T-Bar** will turn on/off the corresponding button LEDs along the PGM row.

KEY 1 ADJUST / KEY 2 ADJUST button LEDs indicate knob functionality. Rotate the knob right and the **KEY 2 ADJUST** button will turn red and the **KEY 1 ADJUST** button remains white; rotate the knob left and the **KEY 1 ADJUST** button will turn red and **KEY 2 ADJUST** button remains white.

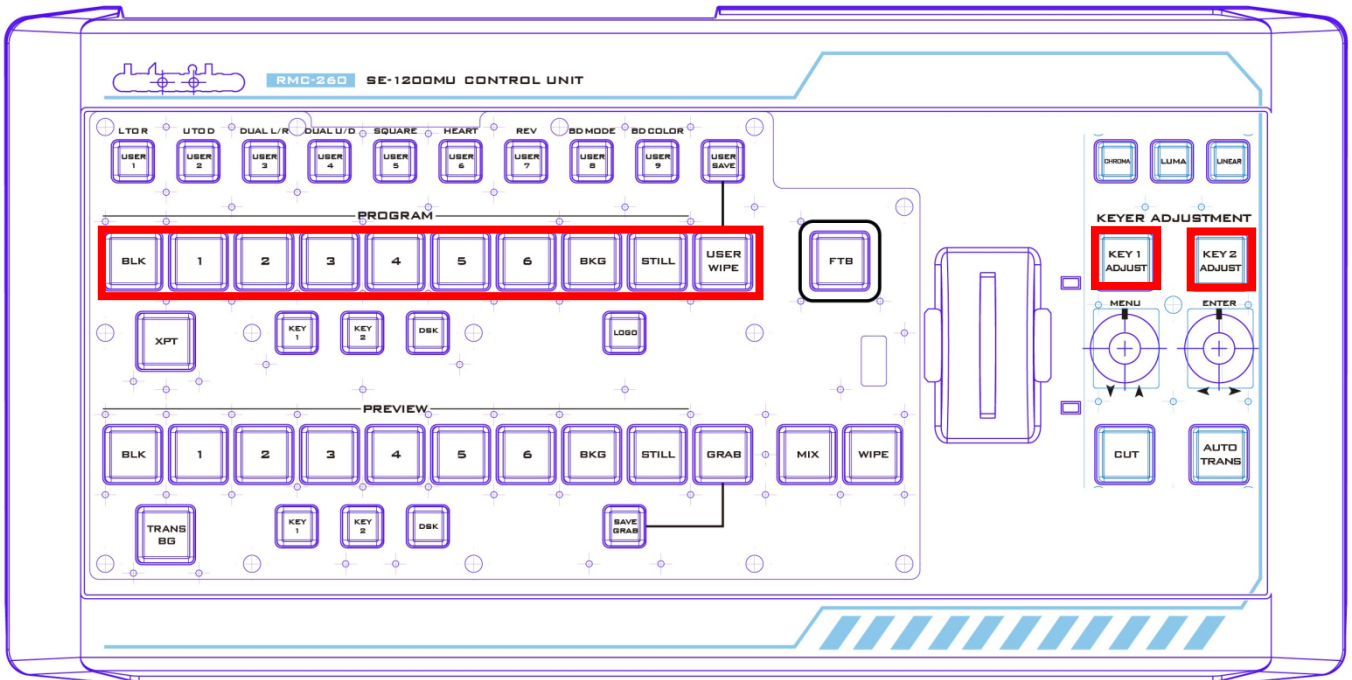

5.7 USER 5 – Exit Configuration and Debug Mode

To exit the configuration and debug mode, press the **MENU** knob to select the **USER 5** button.

6. RS-232 PIN Definition

6.1 Device Port

The table below provides PIN definition of the device's RS-232 port.

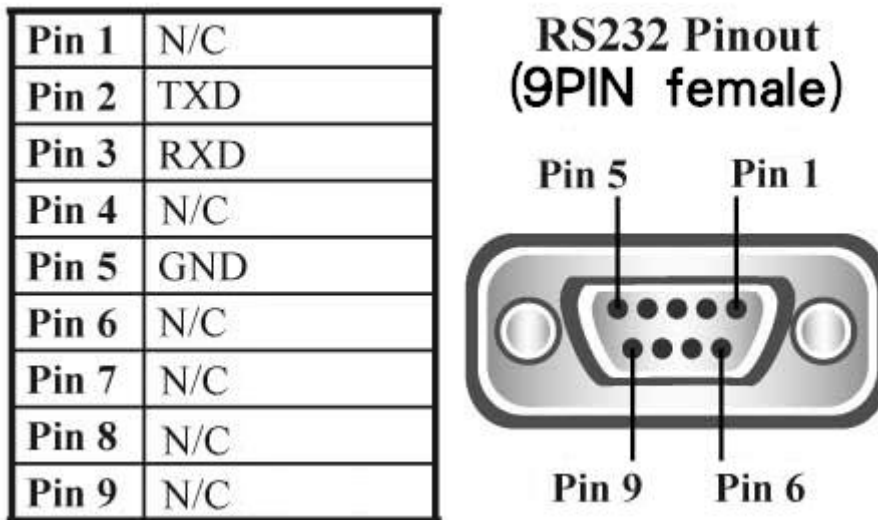

6.2 Cable Connectors

The user may connect the RS-232 cable between the RMC-260 and the SE-1200 MU using a male-to-male cable with the wiring scheme as depicted in the diagram below.

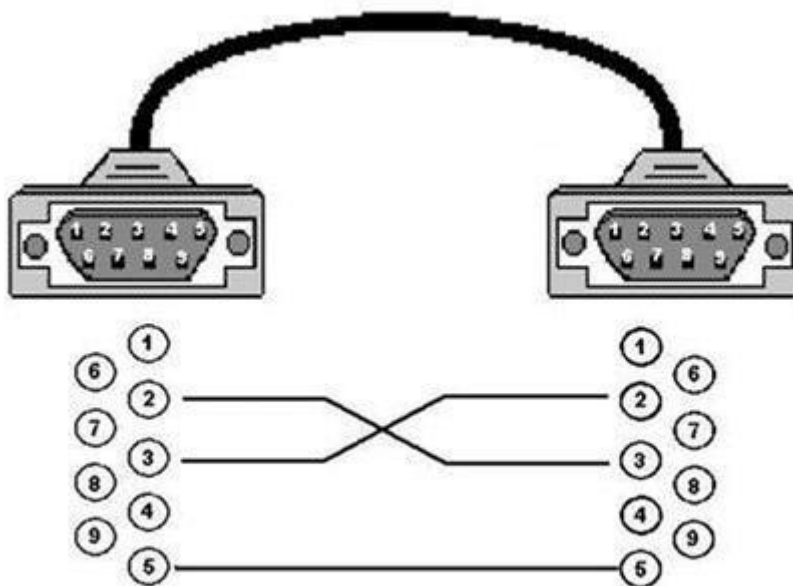

Note: All panel buttons will be lit white after the RMC-260 is powered ON. As soon as the RS-232 connection is established, buttons will be lit in its corresponding functional color. After the RS-232 cable is disconnected, all button LEDs will turn white after a few seconds.

7. Firmware Update

From time to time, Datavideo may release new firmware to either add new features or fix reported bugs in the current RMC-260 firmware. Customers can update the firmware themselves if they wish or they can contact their local dealer or reseller for assistance should they prefer this method.

This section describes the firmware update process and it should take **approximately few minutes to complete**. Once started, **the update process should not be interrupted in any way** as this could result in a non-responsive unit.

Requirement

- Latest firmware update files (bootloader and application firmware)
 - A USB cable not longer than 2 meters
 - A Windows PC with USB 2.0 ports
1. Connect the PC to the F/W UPGRADE connector on the rear panel of the RMC-260 via a USB cable.

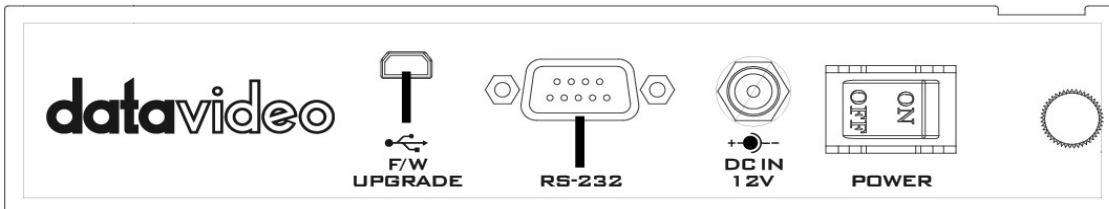

2. Connect the power and switch on the device.
3. The PC will automatically detect the RMC-260 device.
4. Remove firmware.bin file from the device.
5. Copy the latest firmware version file to the device.
6. Firmware update is complete after the firmware file is copied to the device.
7. Safely remove the USB device.
8. Switch off the RMC-260 power.
9. Remove the USB cable connection between the RMC-260 and the PC.

8. Frequently-Asked Questions

This section describes problems that you may encounter while using the RMC-260. If you have questions, please refer to related sections and follow all the suggested solutions. If problem still exists, please contact your distributor or the service center.

1. My PC Control Panel UI cannot work with the RMC-260.
The RMC-260 has to work with the PC Control Panel UI of the version SE-1200MU V1.2.0.7 or above.
2. While SE-1200MU is ON, loss of connection between SE-1200MU and RMC-260 is experienced after hot plugging RS-232 connection repeatedly.
Loss of connection does not usually occur when hot plugging RS-232 connection repeatedly, however, after 5 to 6 times, connection might still be lost; wait for approximately 72 seconds, and the connection will be re-established.
3. The DSK is not transitioned when I move the T-bar.
DSK transition can only be executed using the CUT and AUTO buttons; T-BAR cannot be used for DSK transition.

9. Dimensions

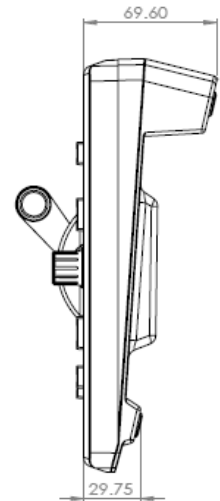
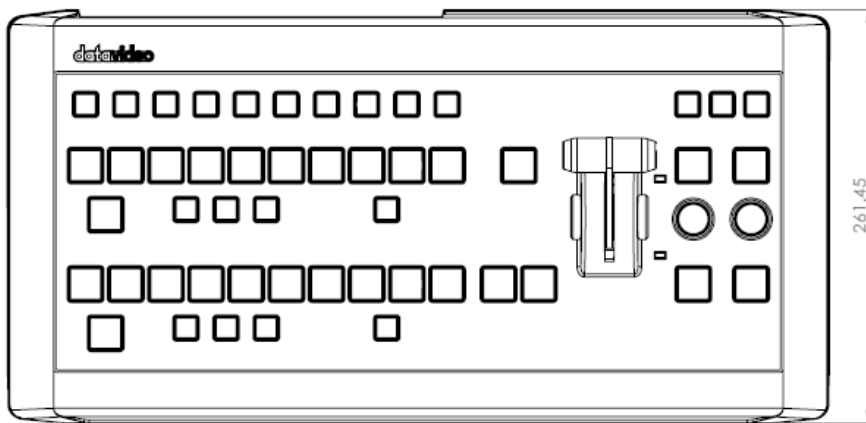
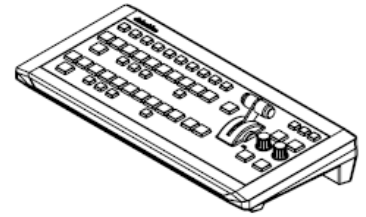
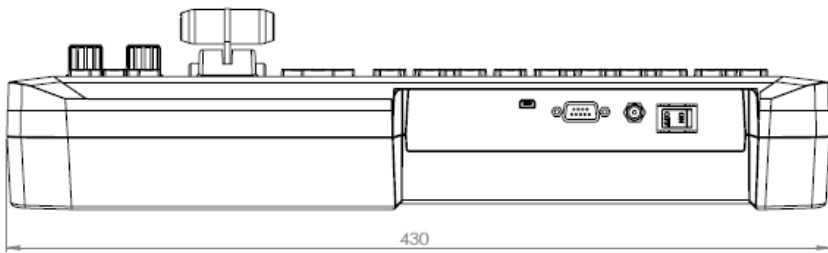

All measurements in millimetres (mm)

10. Specifications

Communication Interface	RS-232
Data Rate	19200 Baud
Firmware Update	USB
Power Supply	Input AC 100 ~ 240 V Switching Adapter Output DC 12V
Operating Temperature	0°C to 50°C (32°F to 122°F)
Storage Humidity	10% to 90% (non condensing)
Dimensions (mm)	430.0 x 216.5 x 69.6
Net Weight	1.28 Kg
Certification	CE, FCC

Service & Support

It is our goal to make owning and using Datavideo products a satisfying experience. Our support staff is available to assist you to set up and operate your system. Contact your local office for specific support requests. Plus, please visit www.datavideo.com to access our FAQ section.

China Shanghai
Datavideo Technologies China Co
601, Building 10, No. 1228,
Rd. Jiangchang,
Jingan District, Shanghai
Tel: +86 21-5603 6599
Fax: +86 21-5603 6770
E-mail: service@datavideo.cn

China Beijing
Datavideo Technologies China Co
No. 812, Building B, Wankai Center,
No. 316, Wan Feng Road, Fengtai District,
Beijing, China
Tel: +86 10-8586 9034
Fax: +86 10-8586 9074
E-mail: service@datavideo.cn

China Chengdu
Datavideo Technologies China Co
B-823, Meinian square, No. 1388,
Middle of Tianfu Avenue, Gaoxin District,
Chengdu, Sichuan
Tel: +86 28-8613 7786
Fax: +86 28-8513 6486
E-mail: service@datavideo.cn

China Fuzhou
Datavideo Technologies China Co
A1-2318-19 Room, No. 8, Aojiang Road,
Taijiang District, Fuzhou, Fujian, China
Tel: 0591-83211756 · 0591-83210187
Fax: 0591-83211262
E-mail: service@datavideo.cn

China Jinan
Datavideo Technologies China Co
902, No. 1 business building,
Xiangtai Square, No. 129,
Yingxiongshan Road, Shizhong District,
Jinan City, Shandong Province, China
Tel: +86 531-8607 8813
E-mail: service@datavideo.cn

Hong Kong
Datavideo Hong Kong Ltd
G/F., 26 Cross Lane
Wanchai, Hong Kong
Tel: +852-2833-1981
Fax: +852-2833-9916
E-mail: info@datavideo.com.hk

India Noida
Datavideo India Noida
A-132, Sec-63, Noida-201307,
India
Tel: +91-0120-2427337
Fax: +91-0120-2427338
E-mail: sales@datavideo.in

India Kochi
Datavideo India Kochi
2nd Floor- North Wing, Govardhan Building,
Opp. NCC Group Headquarters, Chittoor Road,
Cochin- 682035
Tel: +91 4844-025336
Fax: +91 4844-047696
E-mail: sales@datavideo.in

Netherlands
Datavideo Technologies Europe BV
Floridadreef 106
3565 AM Utrecht,
The Netherlands
Tel: +31-30-261-96-56
Fax: +31-30-261-96-57
E-mail: info@datavideo.nl

Singapore
Datavideo Visual Technology(S) Pte Ltd
No. 178 Paya Lebar Road #06-07
Singapore 409030
Tel: +65-6749 6866
Fax: +65-6749 3266
E-mail: info@datavideovirtualset.com

Singapore
Datavideo Technologies (S) PTE Ltd
No. 178 Paya Lebar Road #06-03
Singapore 409030
Tel: +65-6749 6866
Fax: +65-6749 3266
E-mail: sales@datavideo.sg

Taiwan
Datavideo Technologies Co. Ltd
10F. No. 176, Jian 1st Rd., Chung Ho
District, New Taipei City 235, Taiwan
Tel: +886-2-8227-2888
Fax: +886-2-8227-2777
E-mail: service@datavideo.com.tw

United States
Datavideo Corporation
7048 Elmer Avenue.
Whittier, CA 90602,
U.S.A.
Tel: +1-562-696 2324
Fax: +1-562-698 6930
E-mail: sales@datavideo.com

United Kingdom
Datavideo UK Limited
Brookfield House, Brookfield Industrial
Estate, Peakdale Road, Glossop,
Derbyshire, SK13 6LQ
Tel: +44-1457 851 000
Fax: +44-1457 850 964
E-mail: sales@datavideo.co.uk

France
Datavideo France s.a.r.l.
Cit  Descartes 1, rue Albert Einstein
Champs sur Marne 774477 –
Marne la Vall e cedex 2
Tel: +33-1-60370246
Fax: +33-1-60376732
E-mail: info@datavideo.fr



Please visit our website for latest manual update.
www.datavideo.com/product/RMC-260

datavideo
www.datavideo.com