

datavideo

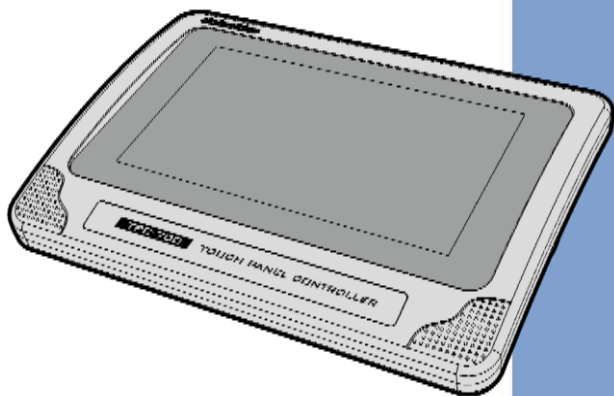

**TOUCH PANEL
CONTROLLER**

TPC-700

Instruction Manual

www.datavideo.com

Table of Contents

TABLE OF CONTENTS	2
WARNINGS AND PRECAUTIONS	4
WARRANTY	5
<i>STANDARD WARRANTY</i>	5
<i>THREE YEAR WARRANTY</i>	6
DISPOSAL	7
CHAPTER 1 INTRODUCTION	8
1.1 FEATURES	8
CHAPTER 2 SYSTEM DIAGRAM	9
CHAPTER 3 CONNECTIONS	10
3.1 FRONT VIEW.....	10
3.2 REAR VIEW	11
3.3 LEFT VIEW	12
3.4 RIGHT VIEW	13
CHAPTER 4 BASIC SETUP	14
4.1 CONNECT BY STATIC IP ADDRESS	14
4.2 CONNECT BY DHCP	14
CHAPTER 5 NETWORK SETTINGS	15
5.1 CONNECT BY STATIC IP ADDRESS	15
5.2 CONNECT BY DHCP	21
5.3 HOW TO RESTORE THE NETWORK SETTINGS DEFAULT VALUES	24
CHAPTER 6 THE 8 PRE-SAVED VIRTUAL SCENES FOR THE SE-3200 & TPC-700 COMBINATION	26
6.1 THE INPUT INTERFACE SETTINGS FOR THE SE-3200 & TPC-700 COMBINATION	27
6.2 THE 8 PRE-SAVED VIRTUAL SCENES FOR THE SE-3200 AND TPC-700 COMBINATION	30
CHAPTER 7. HOW TO SET THE CHROMAKEY, SAVE A STILL TO MEMORY, P-IN-P AND STILL FUNCTIONS	33

CHAPTER 8 INTRODUCTION OF THE SE-3200 APP INTERFACE FOR THE TPC-700	34
8.1 VIRTUAL SCENES	34
8.1.1 HOW TO RECALL THE PRE-MAVED VIRTUAL SCENES BY THE TPC-700	39
8.2 AUX.....	39
8.2.1 HOW TO USE THE “AUX” FUNCTION	40
8.3 CROSS POINT	41
8.3.1 HOW TO USE THE CROSS POINT FUNCTION	41
8.4 FLEX SOURCE	44
8.4.1 HOW TO USE THE FLEX SOURCE FUNCTION.....	45
8.5 PIP	47
8.6 SETUP	48
CHAPTER 9. FIRMWARE UPDATE	52
CHAPTER 10. DIMENSIONS	54
CHAPTER 11. SPECIFICATIONS	55
SERVICE AND SUPPORT	56

Disclaimer of Product & Services

The information offered in this instruction manual is intended as a guide only. At all times, Datavideo Technologies will try to give correct, complete and suitable information. However, Datavideo Technologies cannot exclude that some information in this manual, from time to time, may not be correct or may be incomplete. This manual may contain typing errors, omissions or incorrect information. Datavideo Technologies always recommend that you double check the information in this document for accuracy before making any purchase decision or using the product. Datavideo Technologies is not responsible for any omissions or errors, or for any subsequent loss or damage caused by using the information contained within this manual. Further advice on the content of this manual or on the product can be obtained by contacting your local Datavideo Office or dealer.

FCC Compliance Statement

This device complies with part 15 of the FCC rules. Operation is subject to the following two conditions:

- (1) This device may not cause harmful interference, and
- (2) This device must accept any interference received, including interference that may cause undesired operation.

Warnings and Precautions



1. Read all of these warnings and save them for later reference.
2. Follow all warnings and instructions marked on this unit.
3. Unplug this unit from the wall outlet before cleaning. Do not use liquid or aerosol cleaners. Use a damp cloth for cleaning.
4. Do not use this unit in or near water.
5. Do not place this unit on an unstable cart, stand, or table. The unit may fall, causing serious damage.
6. Slots and openings on the cabinet top, back, and bottom are provided for ventilation. To ensure safe and reliable operation of this unit, and to protect it from overheating, do not block or cover these openings. Do not place this unit on a bed, sofa, rug, or similar surface, as the ventilation openings on the bottom of the cabinet will be blocked. This unit should never be placed near or over a heat register or radiator. This unit should not be placed in a built-in installation unless proper ventilation is provided.
7. This product should only be operated from the type of power source indicated on the marking label of the AC adapter. If you are not sure of the type of power available, consult your Datavideo dealer or your local power company.
8. Do not allow anything to rest on the power cord. Do not locate this unit where the power cord will be walked on, rolled over, or otherwise stressed.
9. If an extension cord must be used with this unit, make sure that the total of the ampere ratings on the products plugged into the extension cord do not exceed the extension cord rating.
10. Make sure that the total amperes of all the units that are plugged into a single wall outlet do not exceed 15 amperes.

11. Never push objects of any kind into this unit through the cabinet ventilation slots, as they may touch dangerous voltage points or short out parts that could result in risk of fire or electric shock. Never spill liquid of any kind onto or into this unit.
12. Except as specifically explained elsewhere in this manual, do not attempt to service this product yourself. Opening or removing covers that are marked "Do Not Remove" may expose you to dangerous voltage points or other risks, and will void your warranty. Refer all service issues to qualified service personnel.
13. Unplug this product from the wall outlet and refer to qualified service personnel under the following conditions:
 - a. When the power cord is damaged or frayed;
 - b. When liquid has spilled into the unit;
 - c. When the product has been exposed to rain or water;
 - d. When the product does not operate normally under normal operating conditions. Adjust only those controls that are covered by the operating instructions in this manual; improper adjustment of other controls may result in damage to the unit and may often require extensive work by a qualified technician to restore the unit to normal operation;
 - e. When the product has been dropped or the cabinet has been damaged;
 - f. When the product exhibits a distinct change in performance, indicating a need for service.

Warranty

Standard Warranty

- Datavideo equipment are guaranteed against any manufacturing defects for one year from the date of purchase.
- The original purchase invoice or other documentary evidence should be supplied at the time of any request for repair under warranty.
- The product warranty period begins on the purchase date. If the purchase date is unknown, the product warranty period begins on the thirtieth day after shipment from a Datavideo office.
- All non-Datavideo manufactured products (product without Datavideo logo) have only one year warranty from the date of purchase.

- Damage caused by accident, misuse, unauthorized repairs, sand, grit or water is not covered under warranty.
- Viruses and malware infections on the computer systems are not covered under warranty.
- Any errors that are caused by unauthorized third-party software installations, which are not required by our computer systems, are not covered under warranty.
- All mail or transportation costs including insurance are at the expense of the owner.
- All other claims of any nature are not covered.
- All accessories including headphones, cables, and batteries are not covered under warranty.
- Warranty only valid in the country or region of purchase.
- Your statutory rights are not affected.

Three Year Warranty

- All Datavideo products purchased after July 1st, 2017 are qualified for a free two years extension to the standard warranty, providing the product is registered with Datavideo within 30 days of purchase.
- Certain parts with limited lifetime expectancy such as LCD panels, DVD drives, Hard Drive, Solid State Drive, SD Card, USB Thumb Drive, Lighting, Camera module, PCIe Card are covered for 1 year.
- The three-year warranty must be registered on Datavideo's official website or with your local Datavideo office or one of its authorized distributors within 30 days of purchase.



Disposal

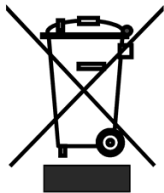

For EU Customers only - WEEE Marking

This symbol on the product or on its packaging indicates that this product must not be disposed of with your other household waste. Instead, it is your responsibility to dispose of your waste equipment by handing it over to a designated collection point for the recycling of waste electrical and electronic equipment. The separate collection and recycling of your waste equipment at the time of disposal will help to conserve natural resources and ensure that it is recycled in a manner that protects human health and the environment. For more information about where you can drop off your waste equipment for recycling, please contact your local city office, your household waste disposal service or the shop where you purchased the product.

Chapter 1 Introduction

Datavideo TPC-700 is the best assistant for all 3200 switchers, and VGB-2000 presentation system. The SE-3200 and VGB-2000 Apps that are installed on the TPC-700 contain presets of common operation functions. Just tap on the screen to easily select different presets. Each button can be customized to your liking. Multi-camera Virtual Studio switching, AUX output, Crosspoint, Flex Source, and PIP assignment can be done by the TPC-700. Easy to transport to your live production show on the go. Quick connection. Simple installation.

1.1 Features

- The Touch Panel supports 800 x 480 resolution.
- Supports Wall mount installation and complies to standard VESA dimensions: 10cm x 10cm, 7.5cm x 7.5cm
- 7" Capacitive Touch Panel

Chapter 2 System Diagram

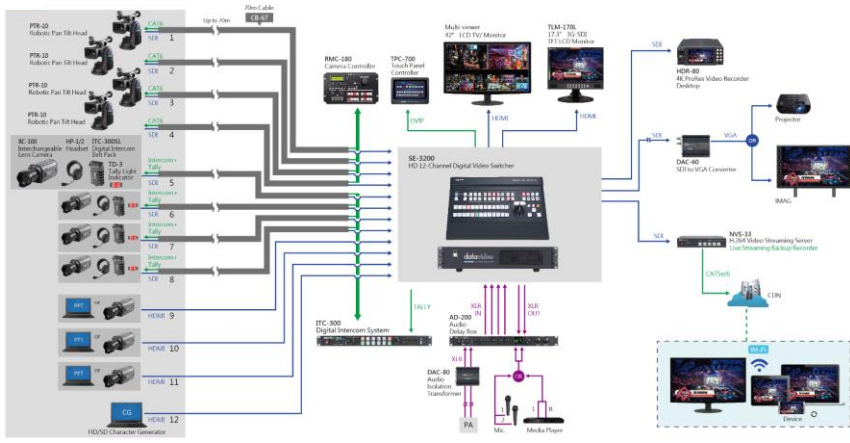

Chapter 3 Connections

This chapter will show you the connections of the TPC-700 Touch Panel Controller. For the details of the TPC-700, please refer to following chapters.

3.1 Front View



Interface	Description
	Touch Panel This is the touch panel of the TPC-700 touch panel controller.

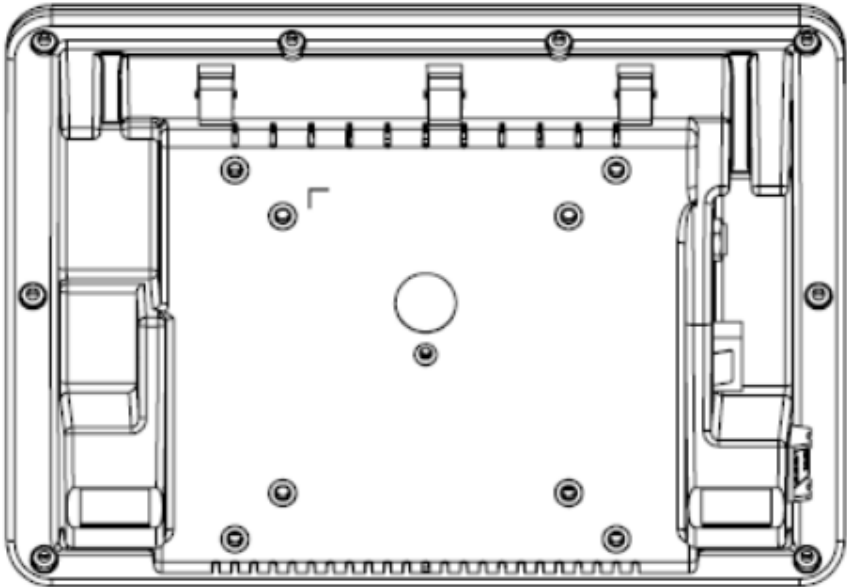

3.2 Rear View

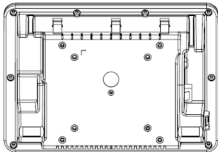

Interface	Description
	<p>Rear Panel This is the rear panel of the TPC-700 Touch Panel Controller. It provides standard VESA 10cm x 10cm & 7.5cm x 7.5cm mounting holes.</p>

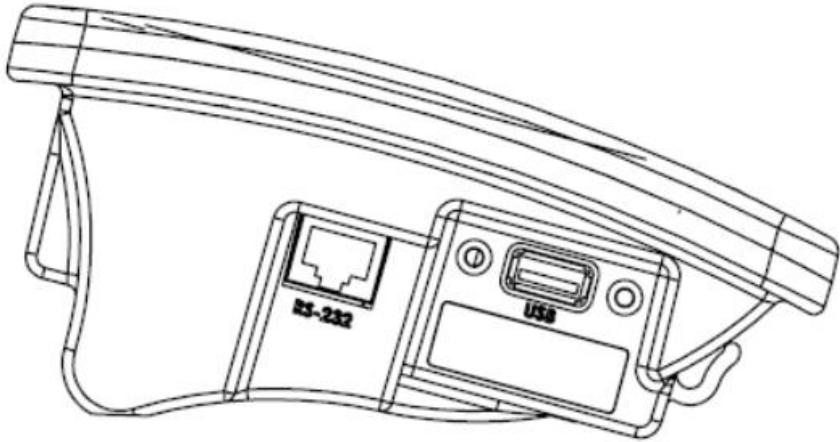

3.3 Left View

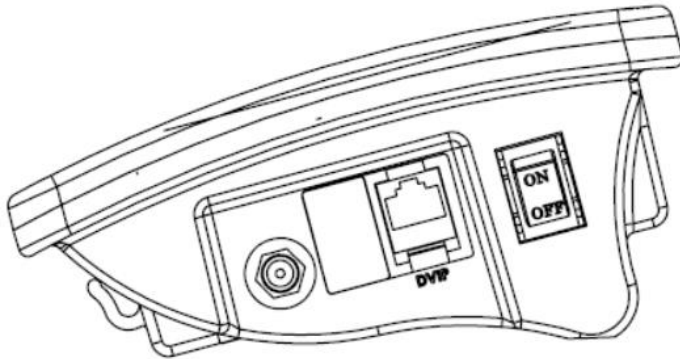

Interface	Description
	<p>RJ-45 Ethernet Interface (for RS-232 Control only)</p> <p>This RJ-45 interface is for RS-232 Control only. If users use the TPC-700 to control the SE-3200, it is no need for this interface to connect due to that the TPC-700 adopts the DVIP protocol to control the SE-3200.</p>
	<p>USB Interface</p> <p>Users can use this USB interface for updating the firmware and for installing the remote control software of other models.</p>

3.4 Right View



Interface	Description
	<p>12VDC IN interface Please connect a 12V DC power cable to this interface for powering the TPC-700.</p>
	<p>RJ-45 Ethernet Interface (For DVIP Control only) Please connect one end of an RJ-45 Ethernet cable to this interface and then please connect the other end of this cable to the device that must be controlled by the DVIP protocol.</p>
	<p>ON/OFF Power Switch Users can turn on or turn off the power of the TPC-700 by this switch.</p>

Chapter 4 Basic Setup

Before using the TPC-700 to control other devices, please make sure that the basic setup of the TPC-700 is done. This chapter will make the SE-3200 HD 12-Channel Digital Video Switcher as an example for explaining how to set the basic setup between the TPC-700 and the SE-3200. Please set the basic setup of the TPC-700 according to following steps.

4.1 Connect by Static IP Address

1. Please use an RJ-45 Ethernet cable to connect from the Ethernet interface on the rear panel of the SE-3200 to the DVIP RJ-45 Ethernet interface on the right side of the TPC-700.

4.2 Connect by DHCP

1. Please use an RJ-45 Ethernet cable to connect from the Ethernet interface on the rear panel of the SE-3200 main unit to the RJ-45 Ethernet interface on your router.
2. Please use an RJ-45 Ethernet cable to connect from the DVIP RJ-45 Ethernet interface on the right side of the TPC-700 to the RJ-45 Ethernet interface of the same router.

Chapter 5 Network Settings

For the network settings of the TPC-700, please see following chapters.

5.1 Connect by Static IP Address

- **If the TPC-700 and the SE-3200 are brand new devices.**

The default value of the **brand new** SE-3200 switcher is the static IP mode and the static IP address is **192.168.100.101**. For the brand new TPC-700 Touch Panel Controller, its default network mode is the static IP address mode and the IP address is **192.168.100.102**. If users want to connect the TPC-700 to the SE-3200 by the static IP mode, please connect the TPC-700 and the SE-3200 with an RJ-45 Ethernet cable.

- **If the IP address of the TPC-700 or the SE-3200 is not the default value**

If the IP address of the SE-3200 is not the default value, please refer to “**Network and Software Setup for Switcher**” in the SE-3200 user manual to know the IP address, subnet mask and default gateway of the SE-3200. And then please set the IP address of the TPC-700 to be within the same IP range for further operation.

Please follow following steps for operation.

1. After opening the TPC-700 interface, please select the “Setup” option.

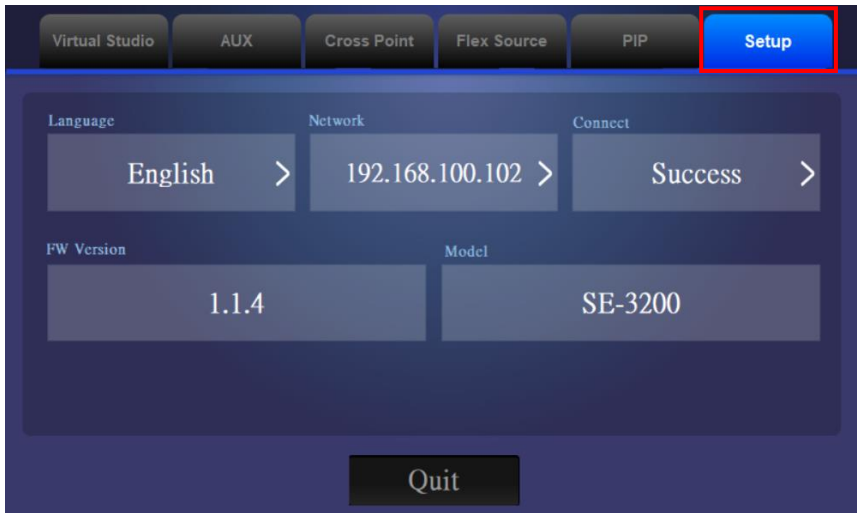

2. Please press the “Network” button.

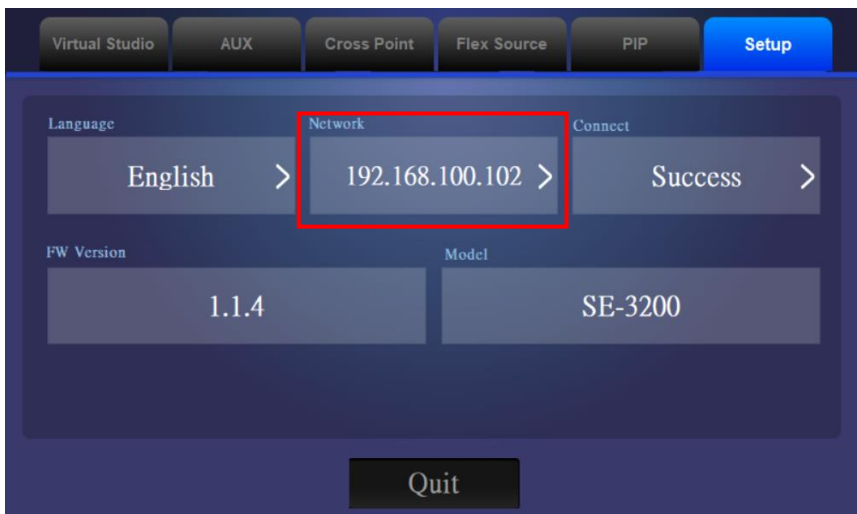

3. Please select the “Static” from the “Addr Mode” drop-down menu.

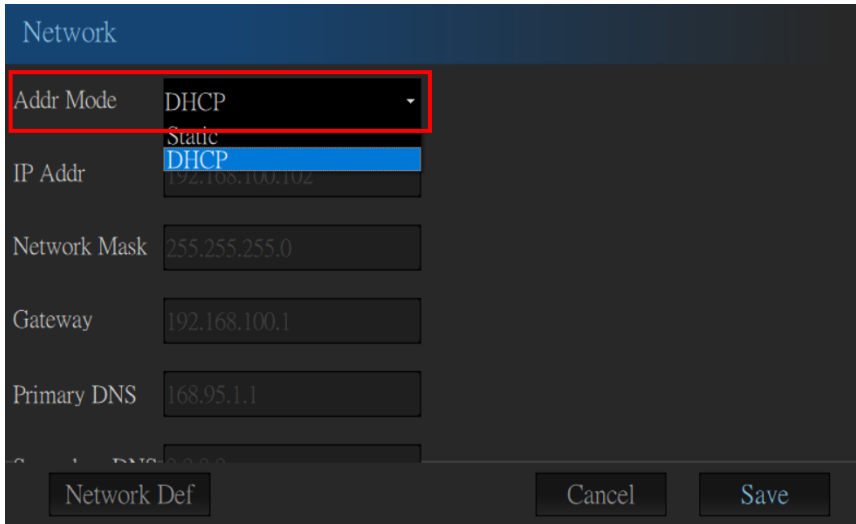

The screenshot shows a 'Network' configuration window with a dark background. The 'Addr Mode' dropdown menu is open, showing 'DHCP' as the current selection and 'Static' as the option being highlighted in blue. Other fields include 'IP Addr' (192.168.100.102), 'Network Mask' (255.255.255.0), 'Gateway' (192.168.100.1), and 'Primary DNS' (168.95.1.1). Buttons for 'Network Def', 'Cancel', and 'Save' are visible at the bottom.

4. Please press the “IP Addr” to enter the IP address which is within the same IP range as the SE-3200.

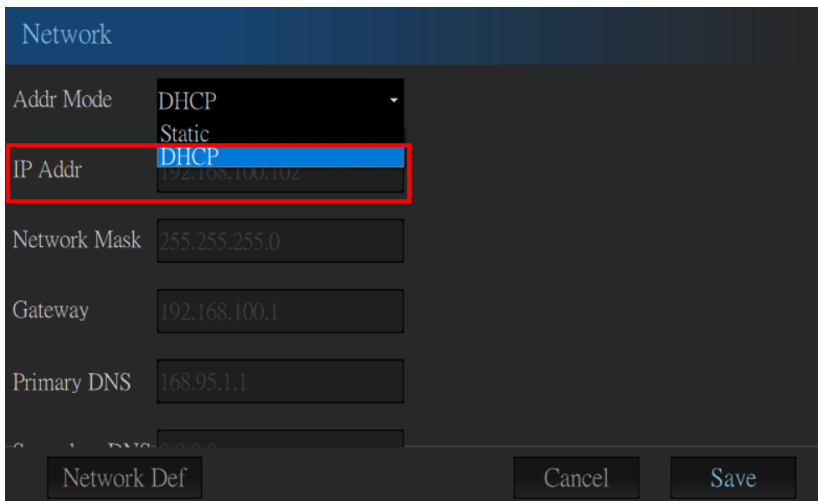

The screenshot shows the same 'Network' configuration window. The 'IP Addr' field is now highlighted with a red box, indicating it is the next step in the configuration process. The 'Addr Mode' dropdown is still open, showing 'Static' as the selected option. The other fields and buttons remain the same as in the previous screenshot.

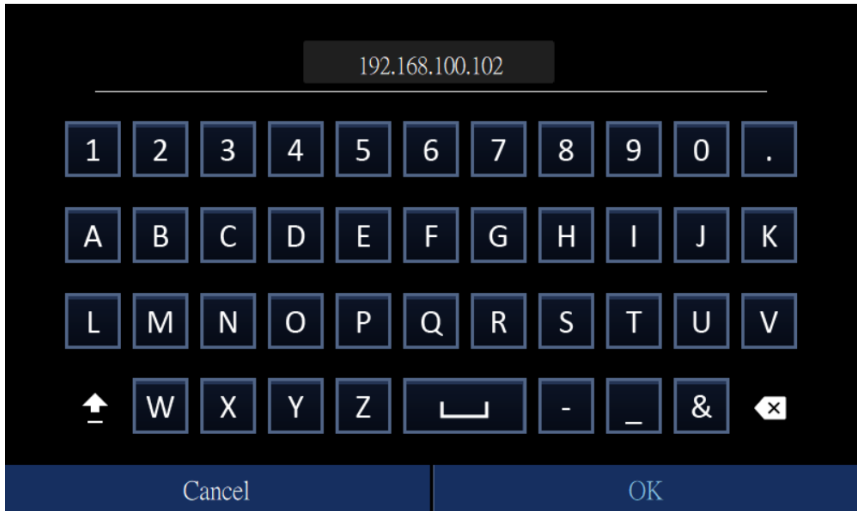

5. Please press the “Network Mask” and the “Gateway” respectively and then please set those two items to be the same value as the SE-3200.

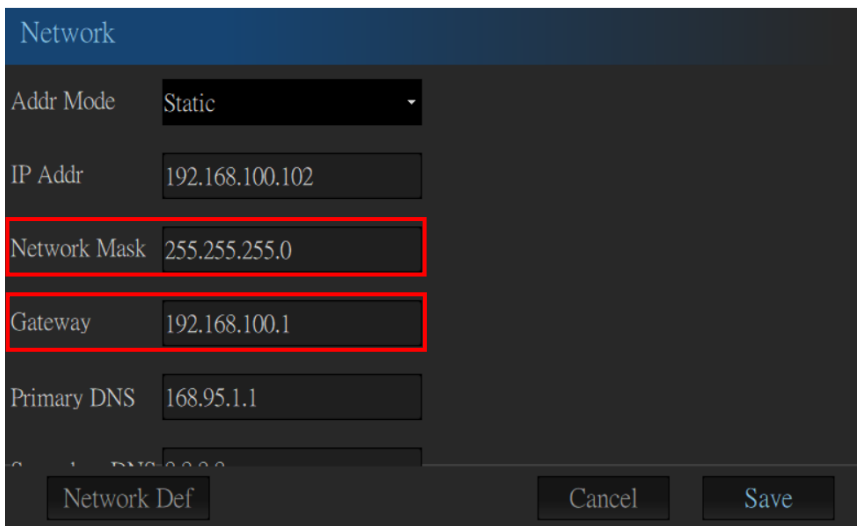

6. Please press the “Save” button.

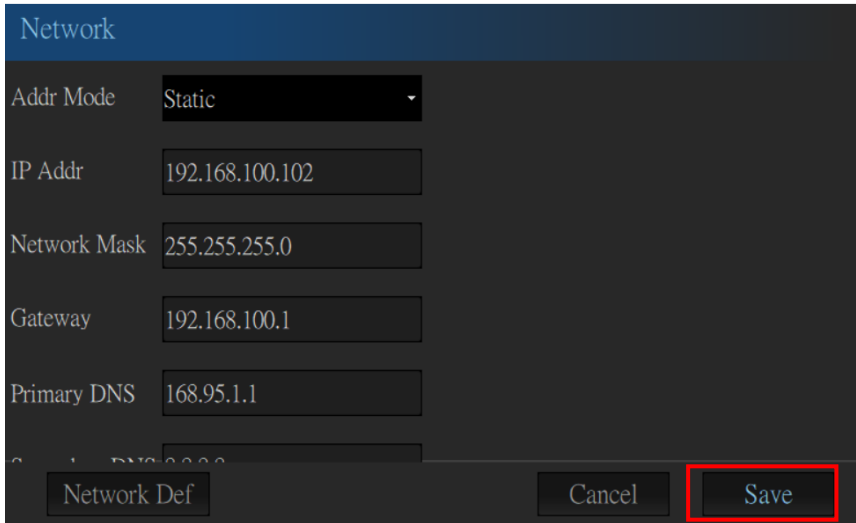

The image shows a network configuration interface with a dark blue header and a black background. The header contains the word "Network" in white. Below the header, there are several configuration fields: "Addr Mode" is set to "Static" in a dropdown menu; "IP Addr" is "192.168.100.102"; "Network Mask" is "255.255.255.0"; "Gateway" is "192.168.100.1"; and "Primary DNS" is "168.95.1.1". At the bottom, there are three buttons: "Network Def", "Cancel", and "Save". The "Save" button is highlighted with a red rectangular border.

7. Please press the “Connect” button.

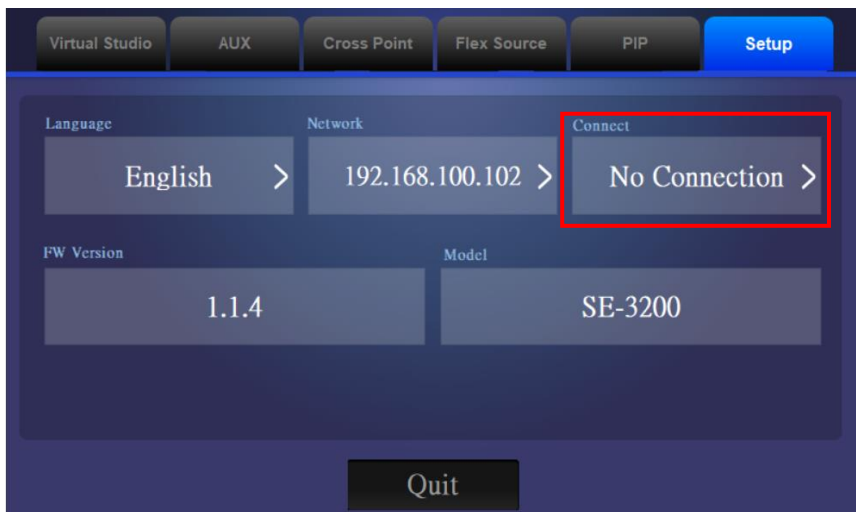

The image shows a main menu interface with a dark blue background. At the top, there are several buttons: "Virtual Studio", "AUX", "Cross Point", "Flex Source", "PIP", and "Setup". The "Setup" button is highlighted in blue. Below these buttons, there are four status indicators: "Language" is "English", "Network" is "192.168.100.102", "Connect" is "No Connection", and "FW Version" is "1.1.4". The "Model" is "SE-3200". At the bottom, there is a "Quit" button. The "Connect" indicator is highlighted with a red rectangular border.

8. Please press the “Scan” button and then it will scan the IP address of the connected device.

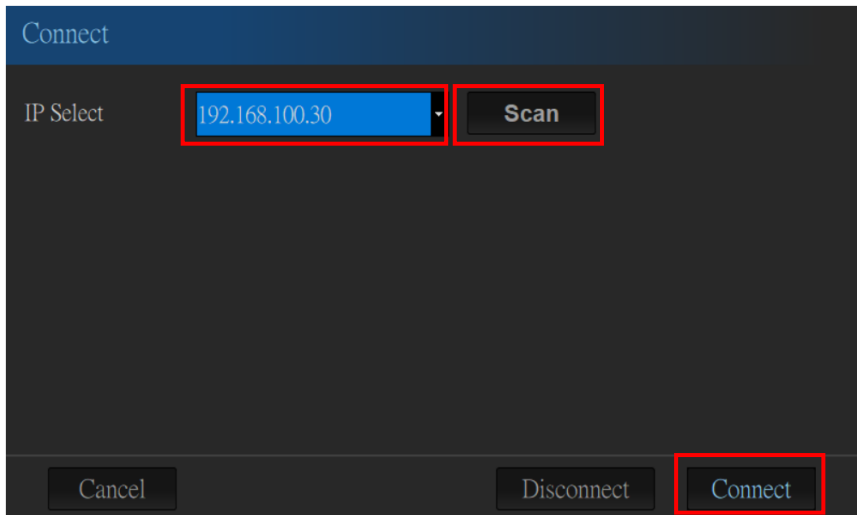

9. Please press the “Connect” button for completing the connection.

5.2 Connect by DHCP

Please follow following steps for connecting the TPC-700 and the SE-3200 by the DHCP Mode.

1. Please open the TPC-700 interface and then please press the “Setup” option.

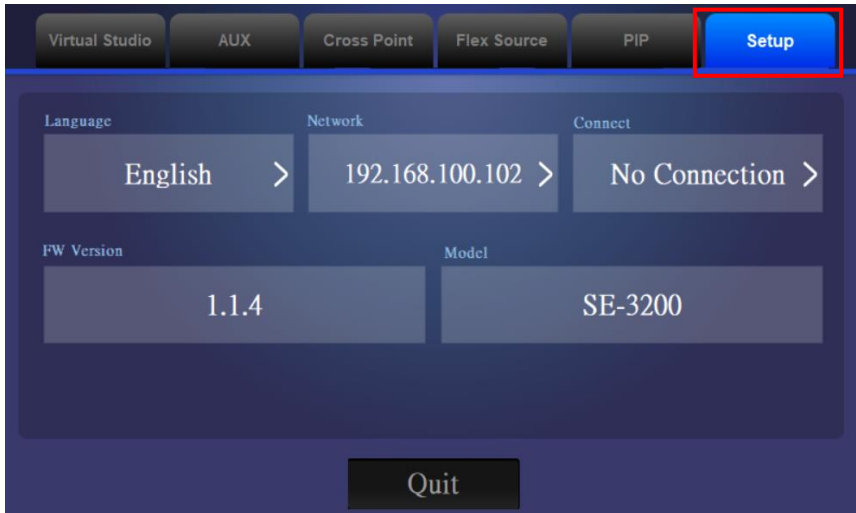

2. Please press the “Network” button.

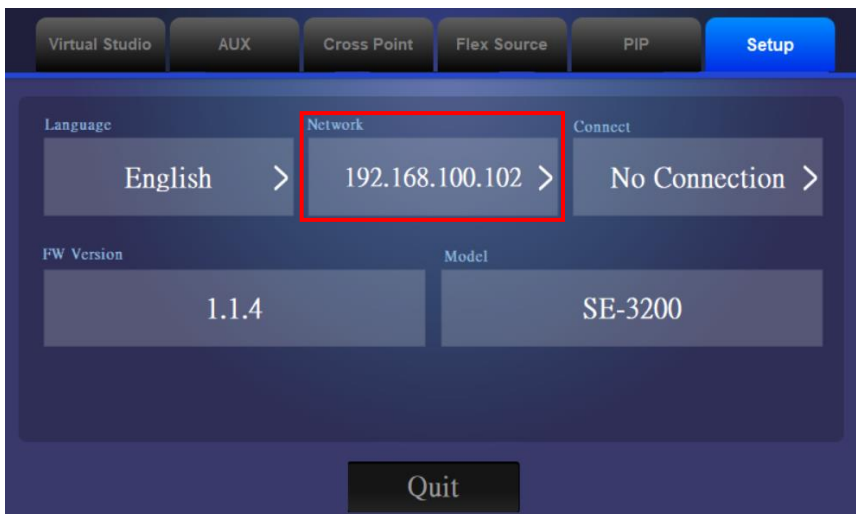

3. Please press the “DHCP” from the drop-down menu and then please press the “Save” button.

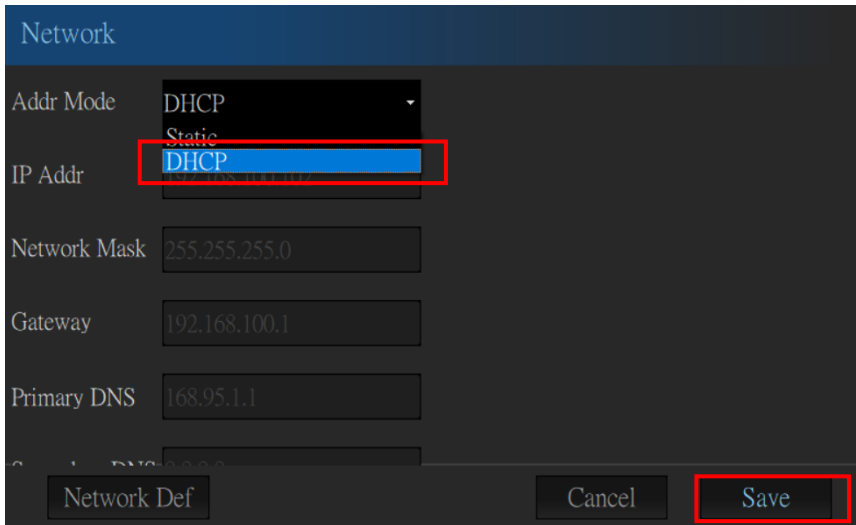

4. Please press the “Connect” button.

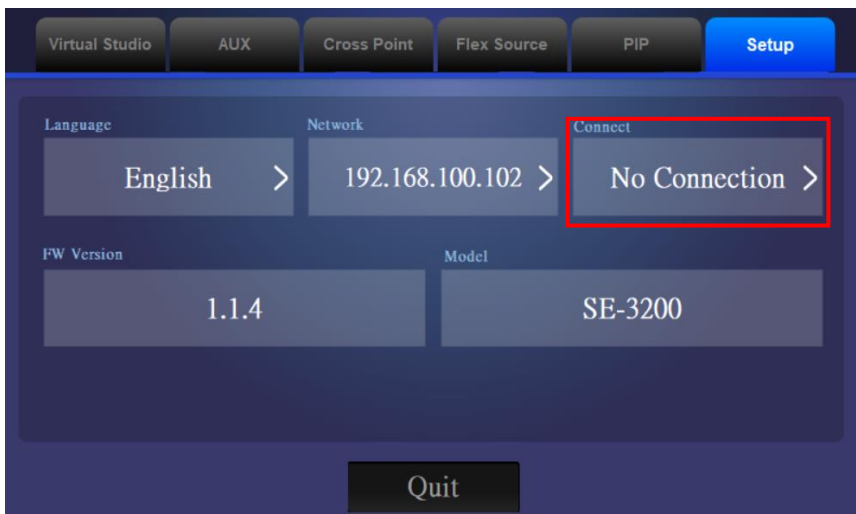

5. Please press the “Scan” button and then it will scan the IP address of the connected device.

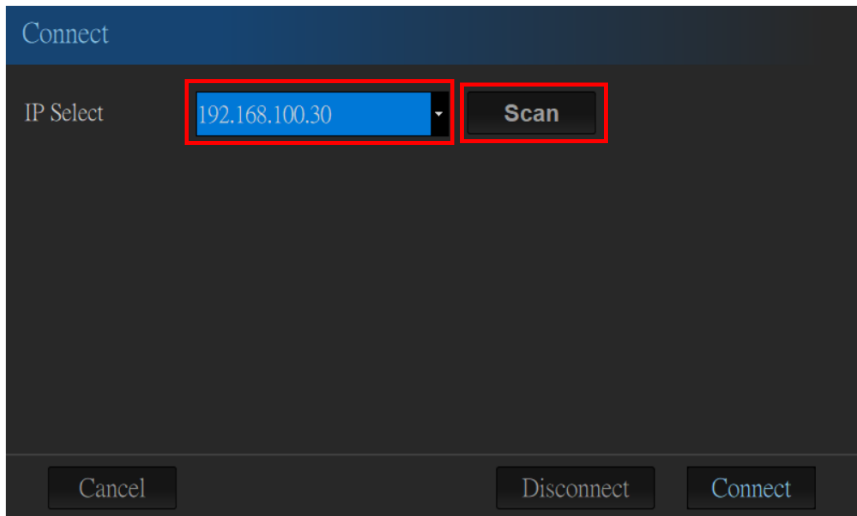

6. Please press the “Connect” button for completing the connection.

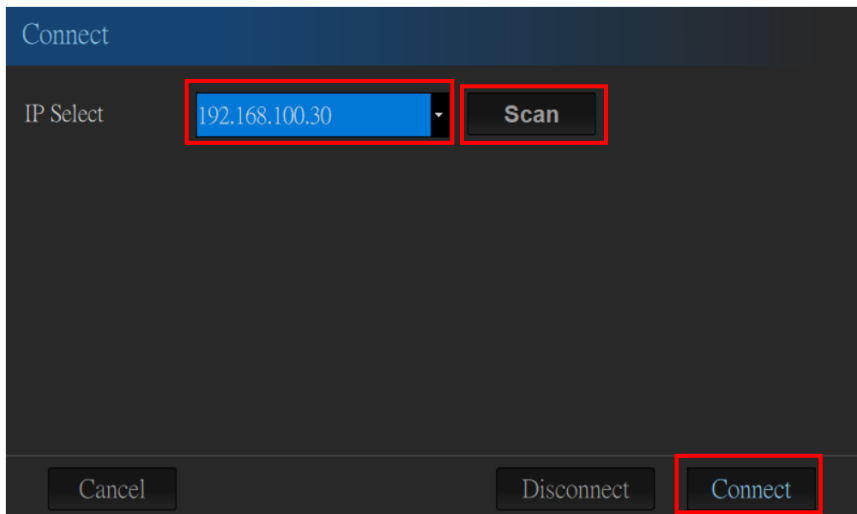

5.3 How to Restore the Network Settings Default Values

Please follow following steps for restoring the TPC-700 network related settings to default values.

1. Please open the TPC-700 App and then please press the “Setup” option.

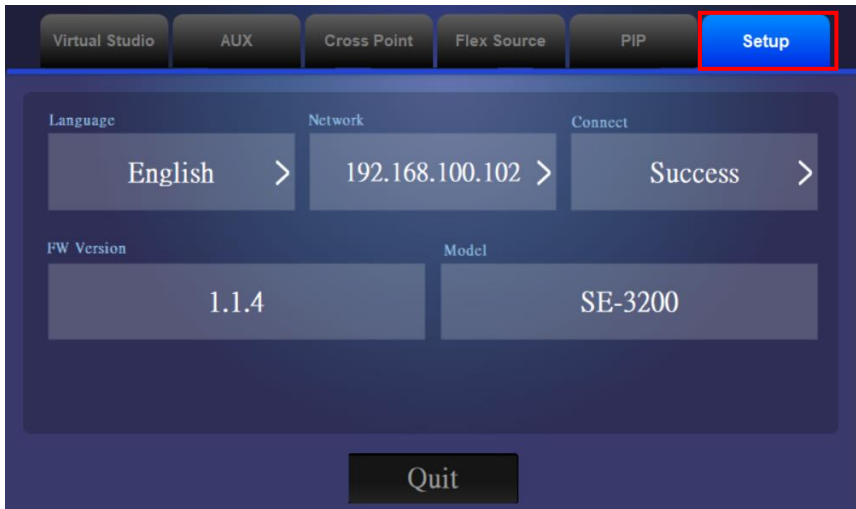

2. Please press the “Network” button.

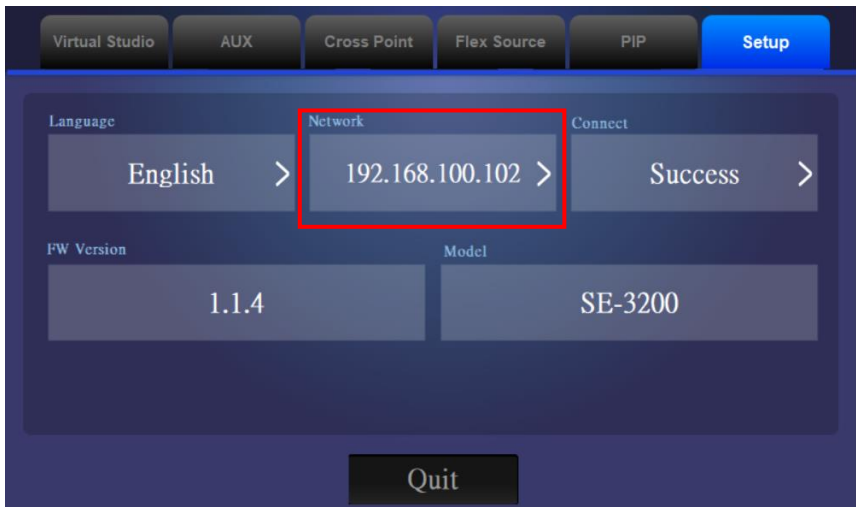

3. Please press the “Network Def” button.

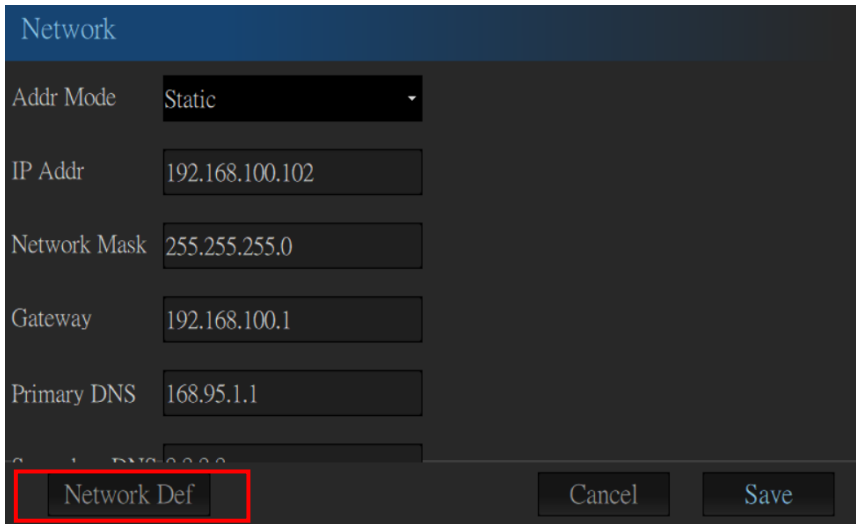

The image shows a network configuration window titled "Network". It contains several input fields: "Addr Mode" is set to "Static"; "IP Addr" is "192.168.100.102"; "Network Mask" is "255.255.255.0"; "Gateway" is "192.168.100.1"; and "Primary DNS" is "168.95.1.1". At the bottom, there are three buttons: "Network Def", "Cancel", and "Save". The "Network Def" button is highlighted with a red rectangular border.

4. The following dialogue box will appear. Please press the “Yes” button and then the network related settings will be restored to factory default values successfully.

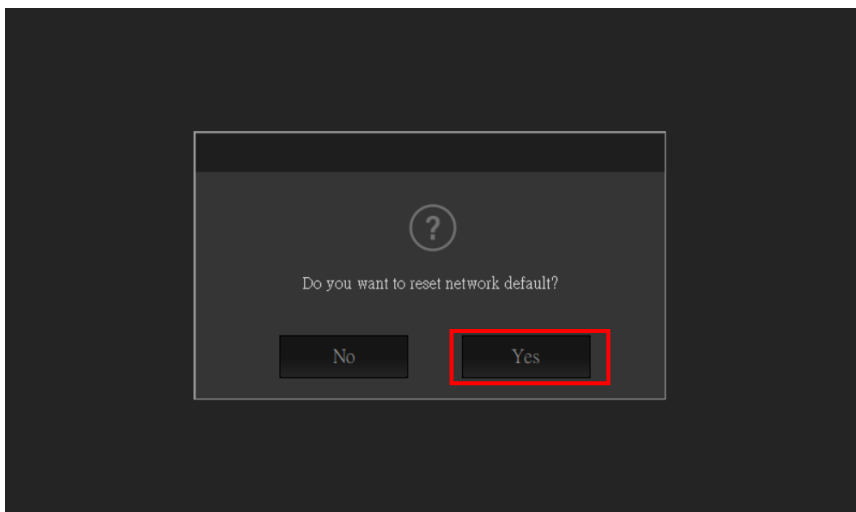

The image shows a confirmation dialog box with a question mark icon at the top. The text inside the dialog box reads "Do you want to reset network default?". At the bottom of the dialog box, there are two buttons: "No" and "Yes". The "Yes" button is highlighted with a red rectangular border.

Chapter 6 The 8 Pre-saved Virtual Scenes for the SE-3200 & TPC-700 combination

Datavideo SE-3200 HD 12-Channel Digital Video Switcher allows users to set up to 4-camera EFP Chromakey effect. So, the SE-3200 & TPC-700 combination allows users to recall the pre-saved 4-camera EFP Chromakey effect virtual scenes easily and rapidly. The default setting for the TPC-700 is that the TPC-700 will recall the No. 101~No. 108 virtual scenes that are pre-saved in the SE-3200. So, please follow following steps for setting the related “User Memory” contents. Please see the example which is shown as following diagram.

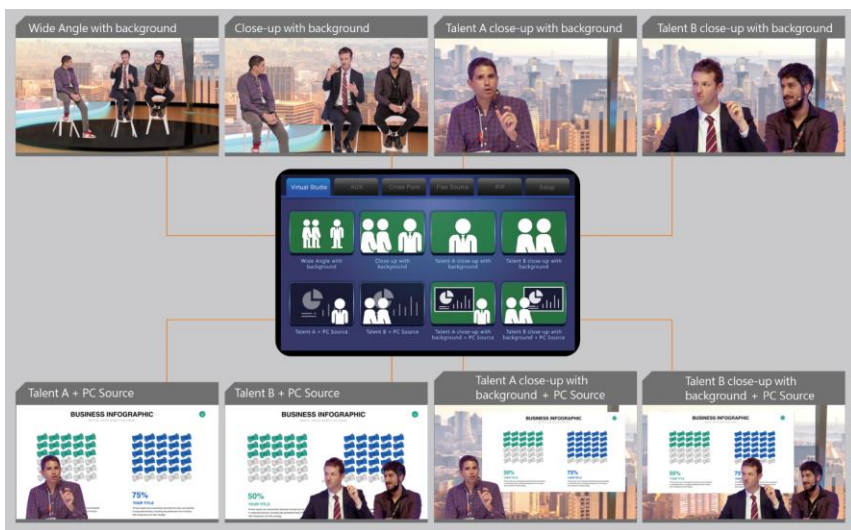

6.1 The Input Interface Settings for the SE-3200 & TPC-700 Combination

Before recalling the No. 108 to No. 108 user memories' virtual scenes, users need to know the corresponding relationship between each interface of the SE-3200 rear panel and the elements for each pre-saved virtual scene.

Connections for the SE-3200 rear panel	Reminders for Setting up the Cameras
SDI IN 1 (CH1)	<ul style="list-style-type: none"><li data-bbox="337 533 1033 639">• Please set the Camera 1 in the middle to shoot the full body shot for the talent and guests who are sitting in front of the green mat. (Wide Angle).  A wide-angle photograph showing three individuals seated on white chairs against a solid green background. The person on the left is wearing a purple jacket and dark pants. The person in the center is wearing a dark suit and a red tie, and is gesturing with their hands. The person on the right is wearing a dark jacket and dark pants. The camera angle is wide, capturing the full bodies of the individuals and the surrounding green space.

SDI IN 2
(CH2)

- Please set the Camera 2 in the middle to shoot the close-up for the talent and guests who are sitting in front of the green mat.



SDI IN 3
(CH3)

- The Camera 3 must be set on the right side to shoot the close-up for the talent who is sitting in front of the green mat.







<p>SDI IN 4 (CH4)</p>	<ul style="list-style-type: none"> The Camera 4 must be set on the left side to shoot the close-up for the guests who are sitting in front of the green mat. 
<p>CH5</p>	<p>The built-in virtual scene from the SE-3200(Wide Angle virtual scene)</p>
<p>CH6</p>	<p>The built-in virtual scene from the SE-3200(The close-up picture is located in the middle)</p>
<p>CH7</p>	<p>The built-in virtual scene from the SE-3200(The picture is located at the left side)</p>
<p>CH8</p>	<p>The built-in virtual scene from the SE-3200(The picture is located at the right side)</p>



CH9

Please connect a PC to the HDMI IN9 interface of the SE-3200(CH9)(for playing slides or videos)

6.2 The 8 Pre-saved virtual scenes for the SE-3200 and TPC-700 Combination

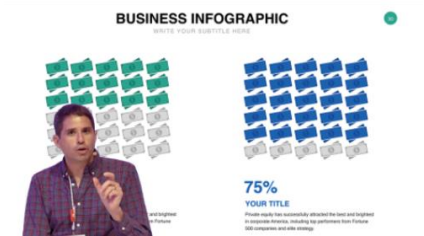
User No.	Combination of Screen Elements	Final Composite Screen
101	Wide Angle with Background (CH1 Chromakey+CH5 Virtual Scene)	Full-Body Chromakey with Virtual Scene 
102	Close-up with Background (CH2 Chromakey+CH6 Virtual Scene)	Half-Body Chromakey with Virtual Scene 

103	Talent A Close-up with Background (CH3 Chromakey+CH7 Virtual Scene)	Half-Body Talent A Chromakey with Virtual Scene 
104	Talent B Close-up with Background (CH4 Chromakey +CH8 Virtual Scene)	Talent B Chromakey with Virtual Scene 
105	Talent A+PC Source (CH3 Chromakey+CH9 Background)	Talent A Half-Body + Content 

<p>106</p>	<p>Talent B+ PC Source (CH4 Chromakey+CH9 Background)</p>	<p>Talent B Half-Body +Content</p> 
<p>107</p>	<p>Talent A Close-up with Background+ PC Source) (CH3 Chromakey +CH7 Background+CH9 PIP)</p>	<p>Talent A Half-Body Chromakey with Virtual Scene+ Content</p> 
<p>108</p>	<p>Talent B Close-up with Background +PC Source (CH4 Chromakey+CH8 Background+CH9 PIP)</p>	<p>Talent B Half-Body Chromakey with Virtual Scene+ Content</p> 

Chapter 7. How to Set the Chromakey, Save a Still to Memory, P-In-P and Still Functions

It is necessary to use the Chromakey and Still related functions of the SE-3200 for controlling the SE-3200 and for recalling the pre-saved virtual scenes directly by the TPC-700. For the setting details and the operating steps, please refer to the **4.2 Keyer**, **4.3 Chroma**, **4.4 P-In-P** and the **Still** related paragraphs of the **4.9 Files** from the SE-3200 user manual.

Chapter 8 Introduction of the SE-3200 App Interface for the TPC-700

The built-in SE-3200 control App for the Datavideo TPC-700 includes “Virtual Studio”, “AUX”, “Cross Point”, “Flex Source”, “PIP” and “Setup” options for users to control the SE-3200 remotely by the TPC-700 and an RJ-45 Ethernet cable. The main interface of the built-in SE-3200 control App for the TPC-7000 is shown as following diagram.

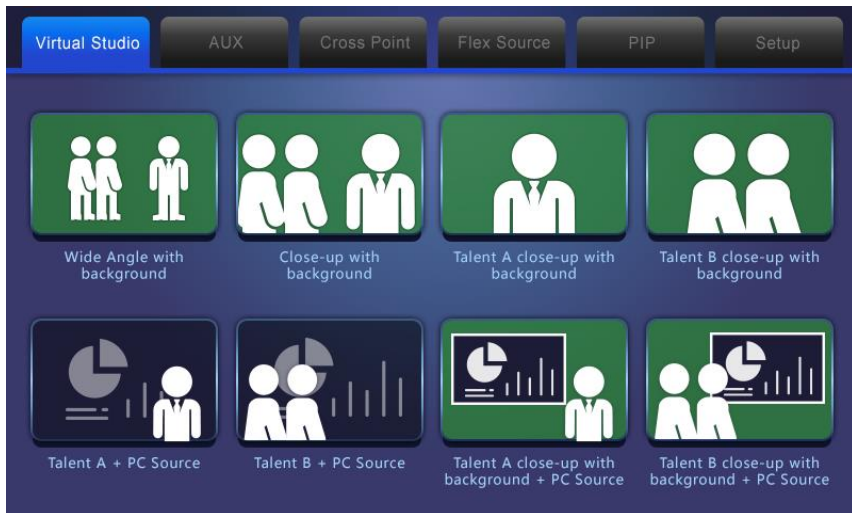

8.1 Virtual Scenes

The Virtual Studio option allows users to recall the pre-saved No. 101 to No. 108 User Mem settings in the SE-3200 by the TPC-700. There are 8 virtual scenes can be used by users including “Wide Angle with background”, “Close-up with background”, “Talent A close-up with background”, “Talent B close-up with background”, “Talent A + PC Source”, “Talent B + PC Source”, “Talent A close-up with background + PC Source”, “Talent B close-up with background + PC Source”. The final

effects of those 8 different virtual scenes will be listed as following diagrams for users' reference.

1. Wide Angle with background



2. Close-up with background



3. Talent A close-up with background



4. Talent B close-up with background



5. Talent A + PC Source

BUSINESS INFOGRAPHIC
WRITE YOUR SUBTITLE HERE

30



and brightest
in Fortune



75%
YOUR TITLE

Private equity has successfully attracted the best and brightest in corporate America, including top performers from Fortune 500 companies and elite strategy.

6. Talent B + PC Source

BUSINESS INFOGRAPHIC
WRITE YOUR SUBTITLE HERE

30



50%
YOUR TITLE

Private equity has successfully attracted the best and brightest in corporate America, including top performers from Fortune 500 companies and elite strategy.

7. Talent A close-up with background + PC Source.

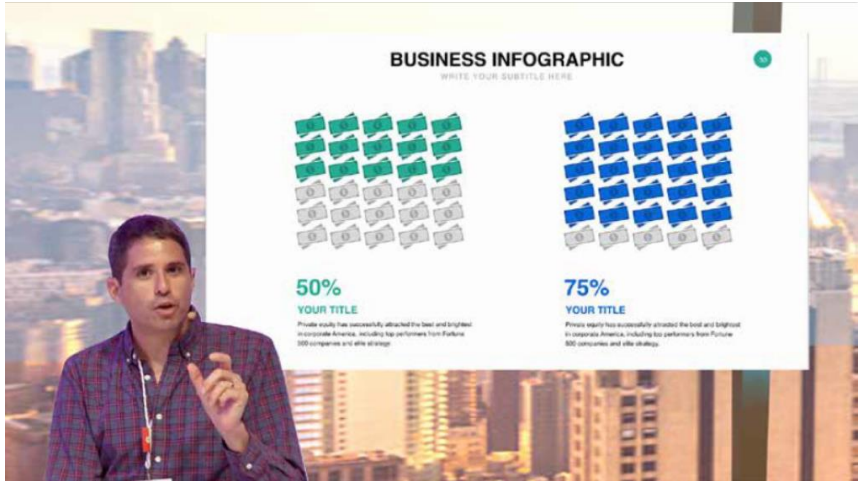

8. Talent B close-up with background + PC Source.



8.1.1 How to Recall the Pre-saved Virtual Scenes by the TPC-700

Please recall the pre-saved virtual scenes by following steps.

1. Please make sure that all of the 8 virtual scenes are saved into the No. 101 to No.108 User Memos in advance. Moreover, please make sure that the SE-3200 main unit, the control panel, the TPC-700 and the router are connected correctly.

2. Please tap your desired virtual scene mode directly from the TPC-700 for recalling the corresponding virtual scene.

8.2 AUX

The Datavideo TPC-700 with the SE-3200 control software allows users to use the “AUX” function. The “AUX” function allows users to assign signal sources including CH1 to CH-12 input sources, PGM, PVW, CLN PGM, CLN PVW, PG + DSK, MULTIV, MULTIV2, STILL1, STILL2, FLEX SRC and FLEX SRC2 randomly to the output interfaces such as SDI1, SDI2, SDI3, SDI4, SDI5, SDI6, SDI6, HDMI1, HDMI2 and HDMI3 to be the output sources. The main interface of the “AUX” option is shown as following diagram.



8.2.1 How to Use the “AUX” Function

Please follow following steps for using the “AUX” function.

1. Please select your desired output interface for outputting the signal source from the “OUTPUT” area.
2. Please select your desired signal source for output from the “SELECT” area.
3. Users can finish the signal assigning for the AUX function.



8.3 Cross Point

The “Cross Point” option allows users to adjust the sequence of the input signals by themselves without changing any input cables. For example, users can assign the signal source which is originally connected to input 2 to be the signal source of input 1. After the setting is finished, users can see that the source picture of the input 2 will be shown on the window of input 1. The main interface of the “Cross Point” is shown as following diagram.



8.3.1 How to Use the Cross Point Function

Please follow following steps for using the Cross Point Function.

1. Please select the input channel that you want to change the input signal source from the “INPUT” area.
2. Please select the channel No. that you want to use as the video input signal source from the “VIDEO XPT” area.
3. Please select the channel No. that you want to use as the audio input signal source from the “AUDIO XPT” area.

Note: If you want to turn off the output of the “VIDEO XPT” area, please tap the “OFF” button. If you want to use the embedded audio of the output video as the output audio source, please tap the “Follow” button.



- **How to Enter the PGM AUDIO SETTING Interface**

1. Please tap the “PGM AUDIO SETTING” button.



2. Users can enter the “PGM AUDIO SETTING” interface to adjust the audio Gain and audio Delay.

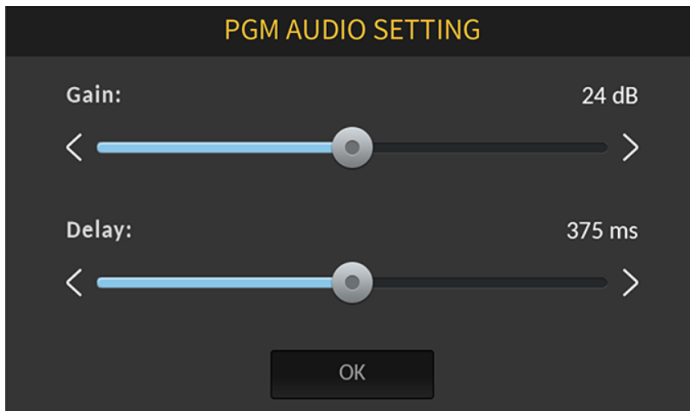

- **How to Use the “PGM AUDIO SETTING” Interface**

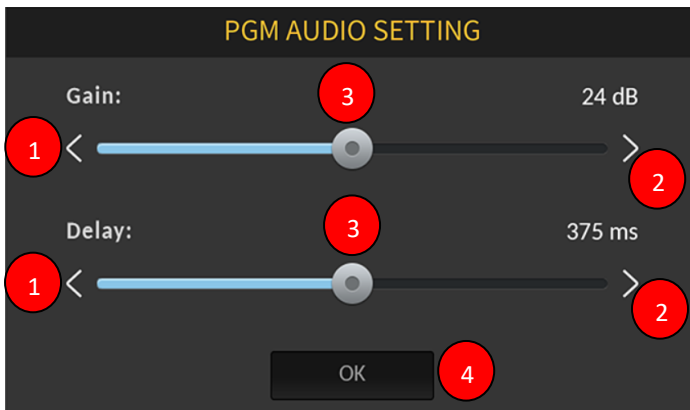

1. Please tap the No.1 arrow to decrease the Audio Gain and Audio Delay.

2. Please tap the No. 2 arrow to increase the Audio Gain and Audio Delay.

3. Please tap the No. 3 slider to increase or decrease the Audio Gain and Audio Delay by dragging the No.3 slider forward or backward.
4. Please tap the No. 4 “OK” button to make the setting effective and to go back to the previous screen.

8.4 Flex Source

The Flex Source function allows users to show videos in different sources simultaneously. Those videos can be shown in PROGRAM and PREVIEW simultaneously and can be set in different permutations.

The Flex Source output consists of a set of background picture and four sets of smaller source videos which are overlaid on the background picture. Those four smaller source videos will be displayed by their corresponding sub-picture windows.

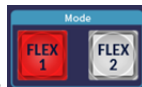

The FLEX1 & FLEX2 buttons within the Flex Source interface allow users to recall an independent different Bgnd background picture respectively and four PIP sub-pictures which are shared by the FLEX 1 and FLEX 2 to form a variety of Flex Source screen combinations. **The two Bgnds for the Flex 1 and Flex 2 are independent respectively. However, all of the four PIP sub-pictures are shared by the Flex 1 and the Flex 2 and those four PIP sub-pictures are linked.** The main interface of the Flex Source option is shown as following diagram.

8.4.1 How to Use the Flex Source Function

Please follow following steps for using the Flex Source function.



How to Set the Background Picture for the Flex Source

1. At first, please tap the “Src Bgnd” button which is located at the “FLEX 1” area to select the background function for the Flex Source.
2. Please tap the source signal channel that you want to use to be the Src background picture from the “SELECT” area. (The source signal channels include BLK, 1~12, Still 1 & Still 2, MATTE and BARS).

How to Set the Sub-Picture Source Signal for the P-In-P of Flex Source

1. At first, please tap the “Src 1”, “Src 2”, “Src 3” or “Src 4” button within the “FLEX 1” area.
2. Please tap the source signal channel that you want to use to be the Src 1, Src 2, Src 3 or Src 4 sub-signal from the “SELECT” area.
3. Please move the white cross box by your finger to determine the sub-picture placement for the Src 1, Src 2, Src 3 or Src 4.
4. Please tap the “X”, “Y” or “SIZE” and then those characters will become orange.

5. Please tap the left or the right arrow button to adjust the scale of the “X”, “Y” or “SIZE”.

Note: When the X, Y or Size character become orange, users can tap that character once again and then the character will become light blue. When the character becomes light blue, users are forbidden to adjust the scale of X, Y or SIZE.



The ON/OFF button allows users to open or to close the display of the Flex Source Src1 to Src 4.

How to Use the FLEX 1 & FLEX 2 Buttons

The FLEX 1 & FLEX 2 buttons allow users to recall an independent Bgnd background pictures for the FLEX 1 and FLEX 2 respectively and four PIP sub-pictures which are shared by the FLEX 1 and FLEX 2 to form a variety of Flex Source screen combinations. Please refer to following examples for realizing the relation between the FLEX 1 & FLEX 2 screen combinations.

Screen Combination No.	The Screen for FLEX 1	The Screen for FLEX 2
1	Flex 1 : Bgnd x 1, PIP x 2	Flex 2 : Different Bgnd x 1, PIP x 2
2	Flex 1 : Bgnd x 1, PIP x 3	Flex 2 : Different Bgnd x 1, PIP x 1
3	Flex 1 : Bgnd x 1, PIP x 4	Flex 2 : Different Bgnd x 1, PIP x 0

Users can know from the above-mentioned examples that the FLEX 1 mode and the FLEX 2 mode can display different Bgnd background screen respectively. However, the four PIP screens must be shared by the FLEX 1 and FLEX 2 together. It means that if all of the four PIP screens are opened, the same PIP screens will be shown on both FLEX 1 and FLEX 2.

Note: If users do not want to show the same PIP screens on both FLEX 1 and

FLEX 2, please remember to use the ON/OFF button  to hide the repetitive PIP screens.

8.5 PIP

The main interface of the PIP option allows users to set the PIP related functions. Please refer to following steps for setting the PIP function.

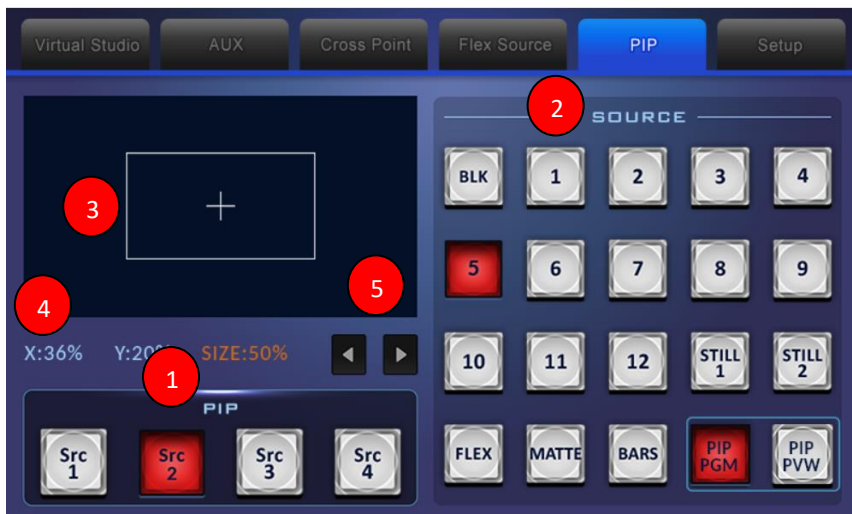

How to Set the Sub-Picture Source Signal for the PIP

1. At first, please tap the “Src 1”, “Src 2”, “Src 3” or “Src 4” button from the PIP area.
2. Please tap the source signal channel that you want to use to be the Src 1, Src 2, Src 3 or Src 4 sub-signal from the “SOURCE” area. (The source signal channels include BLK, 1~12, Still 1 & Still 2, FLEX, MATTE and BARS).
3. Please move the white cross box by your finger to determine the sub-picture placement for the Src 1, Src 2, Src 3 or Src 4.

4. Please tap the “X”, “Y” or “SIZE” and then those characters will become orange.

5. Please tap the left or the right arrow button to adjust the scale of the “X”, “Y” or “SIZE”.

Note: When the X, Y or Size character become orange, users can tap that character once again and then the character will become light blue. When the character becomes light blue, users are forbidden to adjust the scale of X, Y or SIZE.

8.6 Setup

The built-in SE-3200 control interface of the TPC-700 allows users to set many parameters including Language, Network, Connect, FW Version and Model.

The main interface for the Setup is shown as following diagram.

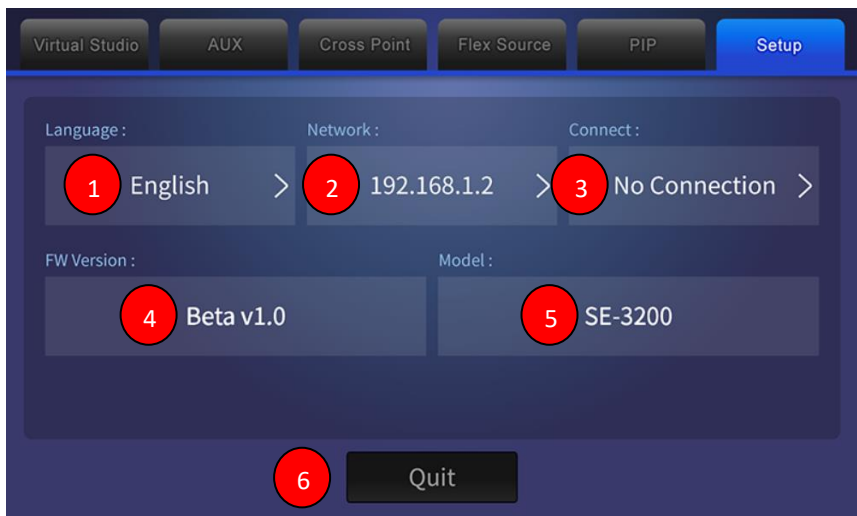

1. Language: This button allows users to select three different language interfaces including Traditional Chinese, English and Simplified Chinese.

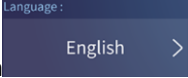
- Please tap this “Language” button .
- After that, users can select their desired language. If the “Save” button is pressed, it will go back to previous page after the setting is saved. If the “Cancel” button is pressed, it will go back to previous page directly.

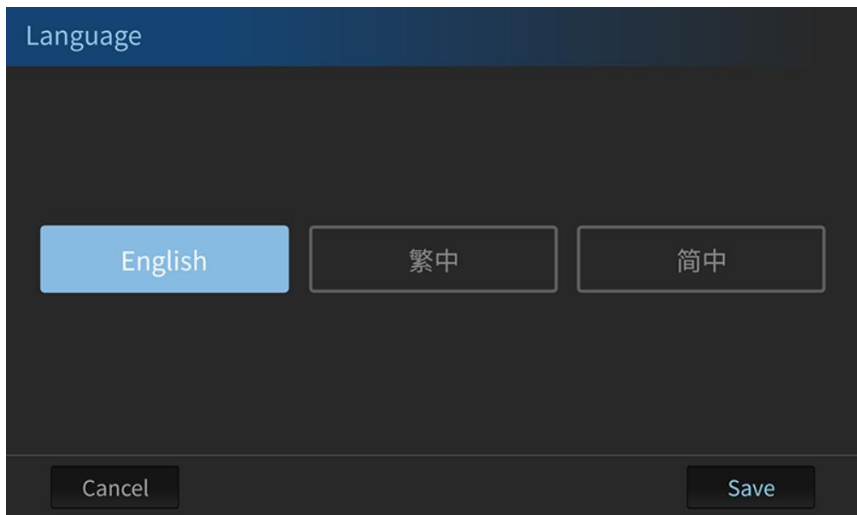

2. Network: This Network option will show current IP address.

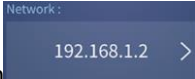
- Please tap the “Network” button .
- The following Network interface will be shown.

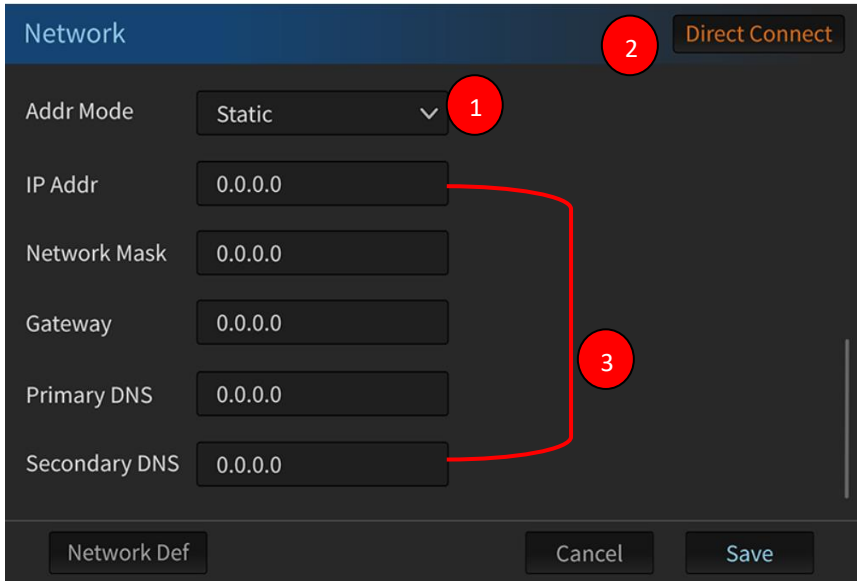

1. Addr Mode: Please select Static IP Mode or DHCP Mode from this drop-down menu.

2. Direct Connect: This is the Direct Connect button.

3. IP Address, Network Mask, Gateway, Primary DNS and Secondary DNS.

- Once the IP Addr, Network Mask, Gateway, Primary DNS or Secondary DNS is pressed, the keyboard which is shown as following diagram will be shown for users to enter related values.

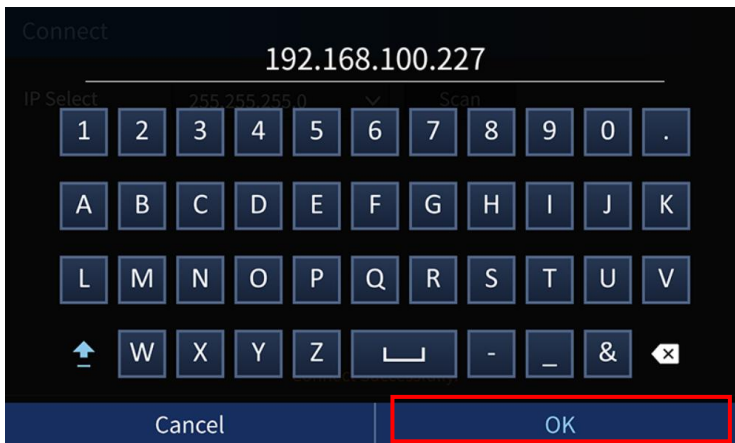

- Please press the “OK” button and then it will go back to previous page and apply those IP address related values which are entered by users respectively. If the “Cancel” button is pressed, it will go back to previous page directly.

3. Connect: Please press the Connect button and then it will enter the interface which is shown as following diagram.

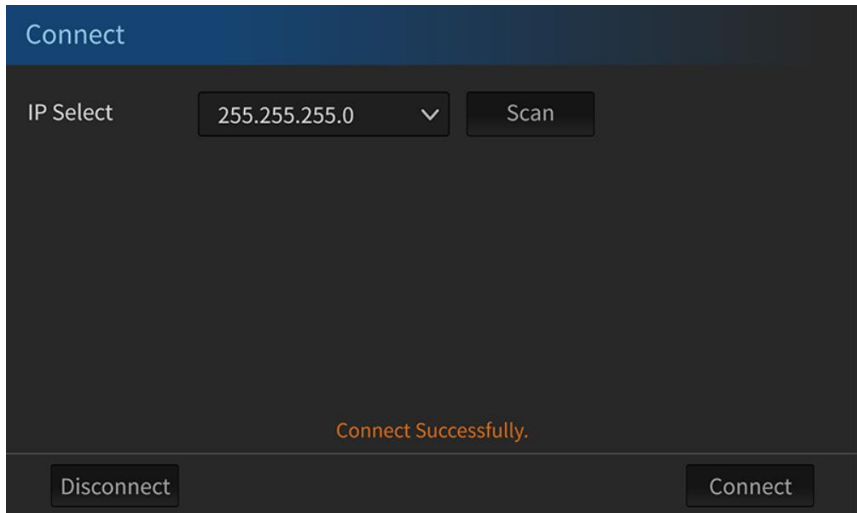

- Please press the “Scan” button and then it will scan current IP address. Press the “Connect” button for connecting the TPC-700 to the SE-3200.

4. FW Version: This will show current firmware version.

5. Model: This will show the model name of the current connected and controlled device.

6. Quit: Press this button allows users to quit from the App and to go back to the main interface of the TPC-700 App.

Chapter 9. Firmware Update

Please follow following steps for updating the firmware for the TPC-700.

1. Please download the latest firmware from the Datavideo official website www.datavideo.com .
2. Please unzip the downloaded firmware “TPC700_SE-3200_v x.x.x” in your PC or laptop.
3. There is a folder which the folder name is “datavideo” after the firmware is unzipped. There are two files including “TPC700_SE3200” and “update” in that datavideo folder.
4. Please copy the whole “datavideo” folder to the root directory of your USB thumb drive.
5. Please insert your USB thumb drive with the “datavideo” folder into the USB port which is located at the left side of the TPC-700.
6. Please turn off and then turn on the power of the TPC-700.
7. The screen of the TPC-700 will be shown as following diagram and the firmware update procedure will be started automatically.



8. After the firmware update procedure is finished, the following screen will be shown, please tap the “OK” button and then all of the firmware update procedure is done.

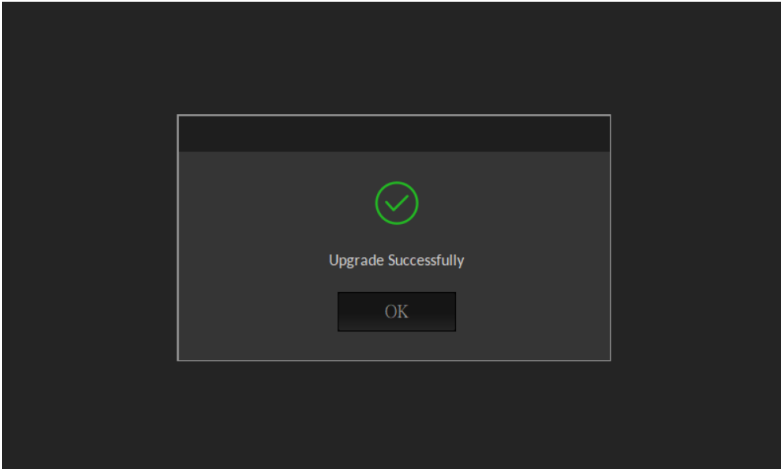

Note: After the firmware update is finished, there is a file which the file name is "done" will be generated automatically by the TPC-700 system and will be saved in your USB thumb drive. If users want to update the same version of the firmware for the next time, please remember to delete that "done" file in advance.

Chapter 10. Dimensions

Unit: mm

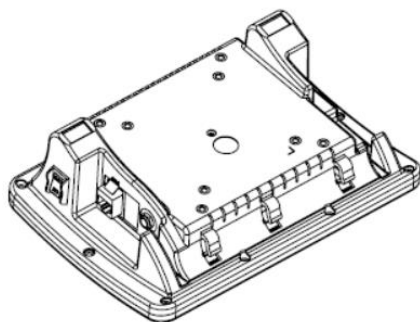
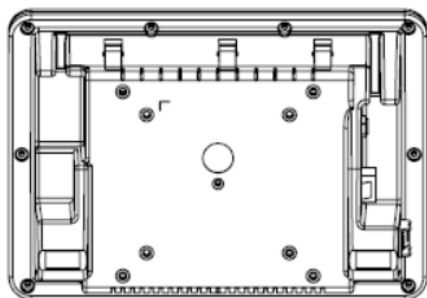
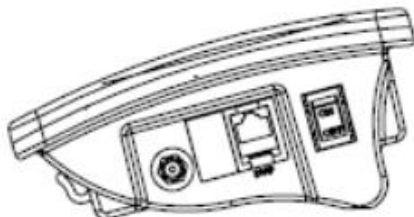
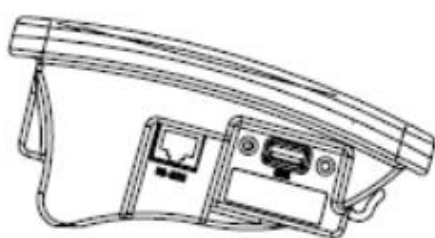
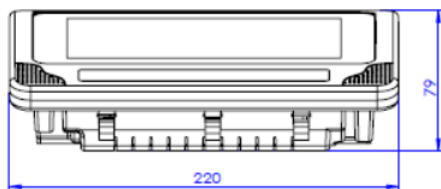
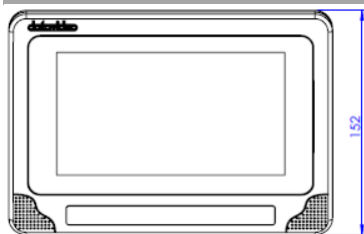

Chapter 11. Specifications

TPC-700 Specifications	
Touch Screen	7" capacitive touch screen
Touch Screen Resolution	800 x 480
Firmware Upgrade	via USB 2.0 interface
Control Protocol	via RS-232(RJ-45 interface)
Power	DC 12V
Power Consumption	10W
Dimension	220 x 152 x 79 (mm)
Weight	0.85Kg
Operating Temp.	0~40 °C

Service & Support

It is our goal to make your products ownership a satisfying experience. Our supporting staff is available to assist you in setting up and operating your system. Please refer to our web site www.datavideo.com for answers to common questions, support requests or contact your local office below.



Please visit our website for latest manual update.
<https://www.datavideo.com/product/TPC-700>

datavideo
www.datavideo.com



@DatavideoUSA @DatavideoIndia2016
@DatavideoEMEA @Datavideojapan
@DatavideoTaiwan @DatavideoLatam
@DatavideoAsia @DatavideoBrasil



@Datavideo
@Datavideo_EMEA
@Datavideo_Taiwan



@DatavideoUSA
@DVTWDCVN



@DatavideoUSA
@DatavideoEurope

All the trademarks are the properties of their respective owners.
Datavideo Technologies Co., Ltd. All rights reserved 2020