

# datavideo

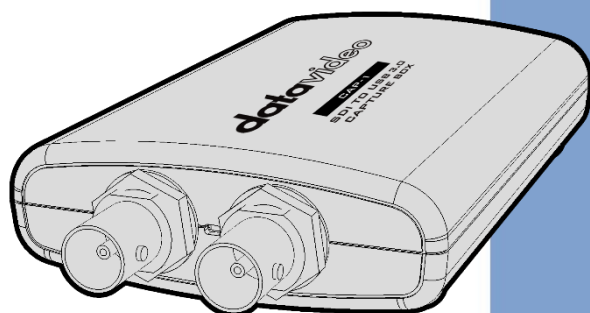

**SDI TO USB 3.0  
CAPTURE BOX**

**CAP-1**

## **Instruction Manual**

[www.datavideo.com](http://www.datavideo.com)

# Table of Contents

<b>TABLE OF CONTENTS</b> .....	<b>2</b>
<b>FCC COMPLIANCE STATEMENT</b> .....	<b>4</b>
<b>WARNINGS AND PRECAUTIONS</b> .....	<b>4</b>
<b>WARRANTY</b> .....	<b>6</b>
<i>STANDARD WARRANTY</i> .....	6
<i>THREE YEAR WARRANTY</i> .....	6
<b>DISPOSAL</b> .....	<b>7</b>
<b>1. PRODUCT OVERVIEW</b> .....	<b>8</b>
1.1 FEATURES .....	8
1.2 SYSTEM DIAGRAM .....	9
<b>2. CONNECTIONS AND CONTROL</b> .....	<b>10</b>
2.1 FRONT PANEL .....	10
2.2 REAR PANEL .....	11
<b>3. BASIC SETUP</b> .....	<b>12</b>
3.1 HOW TO CONNECT YOUR CAP-1 .....	12
<b>4. OBS STREAMING SOFTWARE</b> .....	<b>13</b>
4.1 HOW TO INSTALL THE OBS STREAMING SOFTWARE .....	13
4.2 HOW TO SET THE VIDEO AND AUDIO OF THE OBS STREAMING SOFTWARE .....	19
<b>5. FIRMWARE UPDATE</b> .....	<b>30</b>
<b>6. DIMENSIONS</b> .....	<b>38</b>
<b>7. FREQUENTLY-ASKED QUESTIONS</b> .....	<b>39</b>
<b>8. SPECIFICATIONS</b> .....	<b>45</b>
<b>SERVICE AND SUPPORT</b> .....	<b>48</b>

**Disclaimer of Product and Services**

The information offered in this instruction manual is intended as a guide only. At all times, Datavideo Technologies will try to give correct, complete and suitable information. However, Datavideo Technologies cannot exclude that some information in this manual, from time to time, may not be correct or may be incomplete. This manual may contain typing errors, omissions or incorrect information. Datavideo Technologies always recommend that you double check the information in this document for accuracy before making any purchase decision or using the product. Datavideo Technologies is not responsible for any omissions or errors, or for any subsequent loss or damage caused by using the information contained within this manual. Further advice on the content of this manual or on the product can be obtained by contacting your local Datavideo Office or dealer.

## FCC Compliance Statement

This device complies with part 15 of the FCC rules. Operation is subject to the following two conditions:

- (1) This device may not cause harmful interference, and
- (2) This device must accept any interference received, including interference that may cause undesired operation.

## Warnings and Precautions

1. Read all of these warnings and save them for later reference.
2. Follow all warnings and instructions marked on this unit.
3. Unplug this unit from the wall outlet before cleaning. Do not use liquid or aerosol cleaners. Use a damp cloth for cleaning.
4. Do not use this unit in or near water.
5. Do not place this unit on an unstable cart, stand, or table. The unit may fall, causing serious damage.
6. Slots and openings on the cabinet top, back, and bottom are provided for ventilation. To ensure safe and reliable operation of this unit, and to protect it from overheating, do not block or cover these openings. Do not place this unit on a bed, sofa, rug, or similar surface, as the ventilation openings on the bottom of the cabinet will be blocked. This unit should never be placed near or over a heat register or radiator. This unit should not be placed in a built-in installation unless proper ventilation is provided.
7. This product should only be operated from the type of power source indicated on the marking label of the AC adapter. If you are not sure of the type of power available, consult your Datavideo dealer or your local power company.
8. Do not allow anything to rest on the power cord. Do not locate this unit where the power cord will be walked on, rolled over, or otherwise stressed.
9. If an extension cord must be used with this unit, make sure that the total of the ampere ratings on the products plugged into the extension cord do not exceed the extension cord's rating.
10. Make sure that the total amperes of all the units that are plugged into a single wall outlet do not exceed 15 amperes.
11. Never push objects of any kind into this unit through the cabinet ventilation slots, as they may touch dangerous voltage points or short out parts that could result in risk of fire or electric shock. Never spill liquid of any kind onto or into this unit.
12. Except as specifically explained elsewhere in this manual, do not attempt to service this product yourself. Opening or removing covers that are marked "Do Not Remove" may expose you to dangerous voltage points or other risks, and will void your warranty. Refer all service issues to qualified service personnel.
13. Unplug this product from the wall outlet and refer to qualified service personnel under the following conditions:

- a. When the power cord is damaged or frayed;
- b. When liquid has spilled into the unit;
- c. When the product has been exposed to rain or water;
- d. When the product does not operate normally under normal operating conditions. Adjust only those controls that are covered by the operating instructions in this manual; improper adjustment of other controls may result in damage to the unit and may often require extensive work by a qualified technician to restore the unit to normal operation;
- e. When the product has been dropped or the cabinet has been damaged;
- f. When the product exhibits a distinct change in performance, indicating a need for service.

# Warranty

## ***Standard Warranty***

- Datavideo equipment are guaranteed against any manufacturing defects for one year from the date of purchase.
- The original purchase invoice or other documentary evidence should be supplied at the time of any request for repair under warranty.
- The product warranty period begins on the purchase date. If the purchase date is unknown, the product warranty period begins on the thirtieth day after shipment from a Datavideo office.
- All non-Datavideo manufactured products (product without Datavideo logo) have only one year warranty from the date of purchase.
- Damage caused by accident, misuse, unauthorized repairs, sand, grit or water is not covered under warranty.
- Viruses and malware infections on the computer systems are not covered under warranty.
- Any errors that are caused by unauthorized third-party software installations, which are not required by our computer systems, are not covered under warranty.
- All mail or transportation costs including insurance are at the expense of the owner.
- All other claims of any nature are not covered.
- All accessories including headphones, cables, and batteries are not covered under warranty.
- Warranty only valid in the country or region of purchase.
- Your statutory rights are not affected.

## ***Three Year Warranty***

- All Datavideo products purchased after July 1st, 2017 are qualified for a free two years extension to the standard warranty, providing the product is registered with Datavideo within 30 days of purchase.
- Certain parts with limited lifetime expectancy such as LCD panels, DVD drives, Hard Drive, Solid State Drive, SD Card, USB Thumb Drive, Lighting, Camera module, PCIe Card are covered for 1 year.
- The three-year warranty must be registered on Datavideo's official website or with your local Datavideo office or one of its authorized distributors within 30 days of purchase.



## Disposal

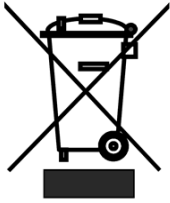

### **For EU Customers only - WEEE Marking**

This symbol on the product or on its packaging indicates that this product must not be disposed of with your other household waste. Instead, it is your responsibility to dispose of your waste equipment by handing it over to a designated collection point for the recycling of waste electrical and electronic equipment. The separate collection and recycling of your waste equipment at the time of

disposal will help to conserve natural resources and ensure that it is recycled in a manner that protects human health and the environment. For more information about where you can drop off your waste equipment for recycling, please contact your local city office, your household waste disposal service or the shop where you purchased the product.



**CE Marking** is the symbol as shown on the left of this page. The letters "CE" are the abbreviation of French phrase "Conformité Européene" which literally means "European Conformity". The term initially used was "EC Mark" and it was officially replaced by "CE Marking" in the Directive 93/68/EEC in 1993. "CE Marking" is now used in all EU official documents.

# 1. Product Overview

Datavideo CAP-1 is an SDI to USB 3.0 Capture Box for supporting fast capturing up to 1080p50/60 input video resolution. Moreover, it supports plug & play operation. Datavideo CAP-1 supports many OS platforms. Moreover, it provides AUDIO IN interface for connecting external connected AUDIO IN source. Furthermore, the CAP-1 provides AUDIO IN/EMBED audio source toggle switch for users to select for different audio source. The embedded audio source or the external connected Audio in source can be used for the audio source of the CAP-1. It gives higher flexibility for CAP-1 compared to general UVC devices.

## 1.1 Features

### Big Five Features

- Supports USB 3.0
- Video Input Interface: SDI x 1
- Supports up to 1080p60 video streaming through the USB 3.0 interface.
- Supports SD/HD/3G SDI Audio and Video Capturing
- Supports Plug & Play Operation with Automatic Video Format Detection Capability (Resolution and Frame Rate).
- Compatible for Popular Third Party Free Apps including OBS and AMCap
- Supports USB 3.0 (MJPG/YUY2) and USB 2.0 (MJPG)



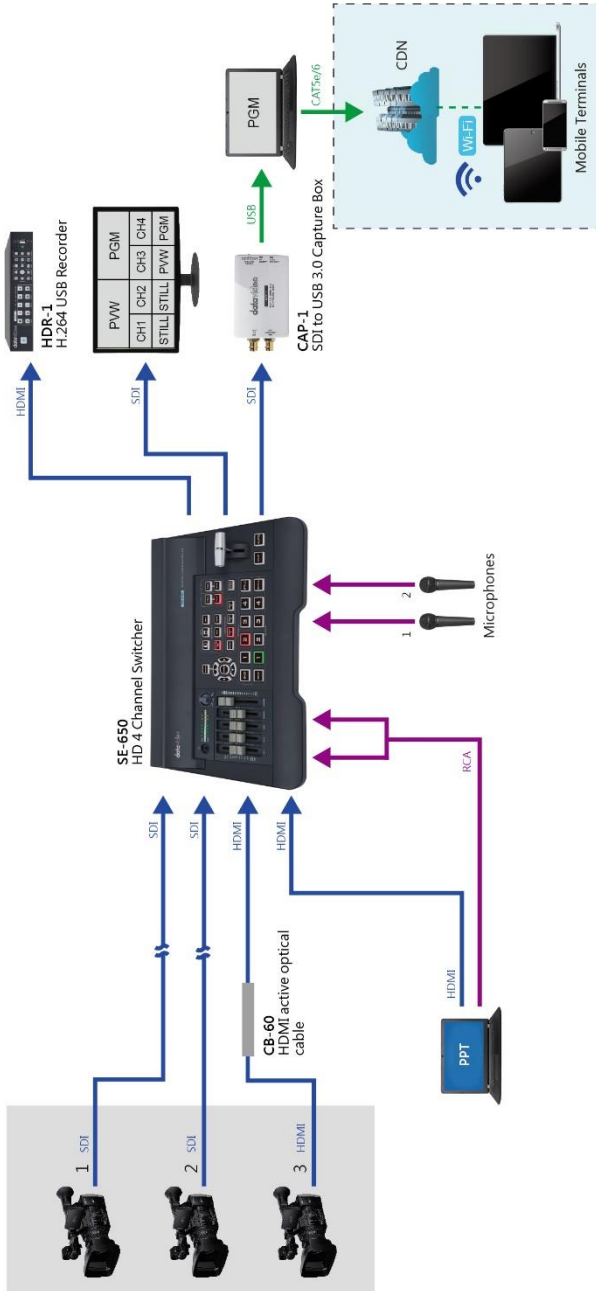

# 1.2 System Diagram



## 2. Connections and Control





### 2.1 Front Panel



	<p><b>USB 3.0 OUT</b></p> <p>Please connect an USB 3.0 cable from this interface to the USB 3.0 interface of your PC or laptop.</p> <p><b>Note: It is a must for you to use the Micro USB 3.0 cable which is bundled in the CAP-1.</b></p>
	<p><b>AUDIO SWITCH(AUDIO IN/EMBED)</b></p> <p>This toggle switch allows users to select their desired audio source for streaming. Pull the toggle switch to the left side for selecting the AUDIO IN external connected audio source to the the streaming audio source. Pull the toggle switch to the right side for selecting the SDI IN embedded audio source to be the streaming audio source.</p>

## 2.2 Rear Panel



	<p><b>LED Indicator</b> This is the LED indicator for the input signal.</p>
	<p><b>SDI IN</b> Please connect to an SDI input source.</p>
	<p><b>SDI LOOP OUT</b> Please connect to a device with an SDI IN interface for looping the SDI IN signal of the CAP-1 directly to the external connected device.</p>
	<p><b>AUDIO IN</b> Please connect to an external connected audio source with 3.5mm analog stereo audio plug.</p>

### 3. Basic Setup

This chapter will show users how to connect the CAP-1 SDI to USB 3.0 Capture Box.

#### 3.1 How to Connect Your CAP-1

Please follow following steps for connecting your CAP-1 to an SDI video source and a Notebook PC.

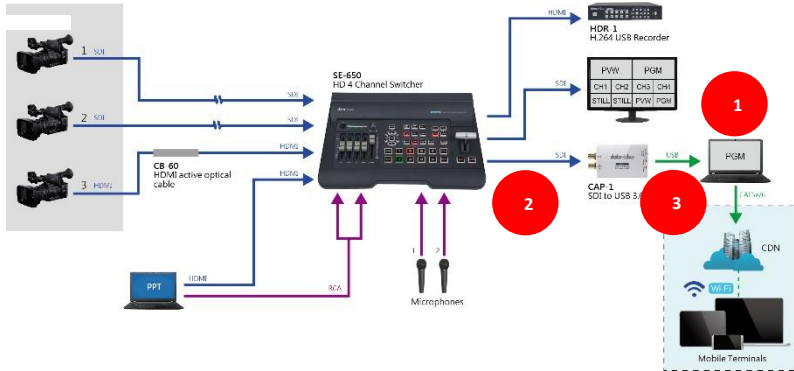

1. Please turn on the power of your Notebook PC.
2. Please connect your SDI video source (Cameras, etc.) to the SDI IN interface of the CAP-1 by using an SDI cable. In this case, the Datavideo SE-650 is used as an example.
3. Please connect from the micro USB 3.0 OUT interface of the CAP-1 to the USB 3.0 interface of your Notebook PC by using a Micro USB-B to USB-A cable.

## 4. OBS Streaming Software

The Datavideo CAP-1 SDI to USB 3.0 Capture Box allows users to capture the SDI input source and then to convert this input source by a USB 3.0 interface to be an input source for the Notebook PC. After that, users can stream the input source to many mainstream streaming platforms such as Youtube and Facebook by using OBS or Xsplit Broadcaster streaming software. This chapter will show you how to install and set the streaming software by using OBS as an example.

Windows OS Platform: For Windows platform user, it is recommended to use the OBS streaming software for streaming. Please download the OBS software from following website and then please install the software.

OBS : <https://obsproject.com/>

### 4.1 How to Install the OBS Streaming Software

Please follow following steps for installing the OBS streaming software. This chapter take Windows platform as an example. The following example will take OBS Studio 24.0.3 (64bit) version as an example.



1. Please visit the OBS website <https://obsproject.com/> and then please click the “Windows” button for downloading the OBS software.

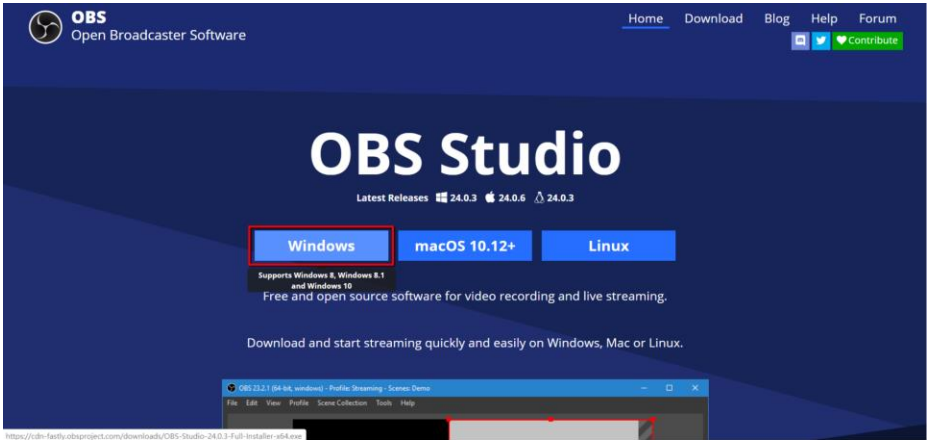

2. Please click the area with the red rectangular for installing the OBS software.

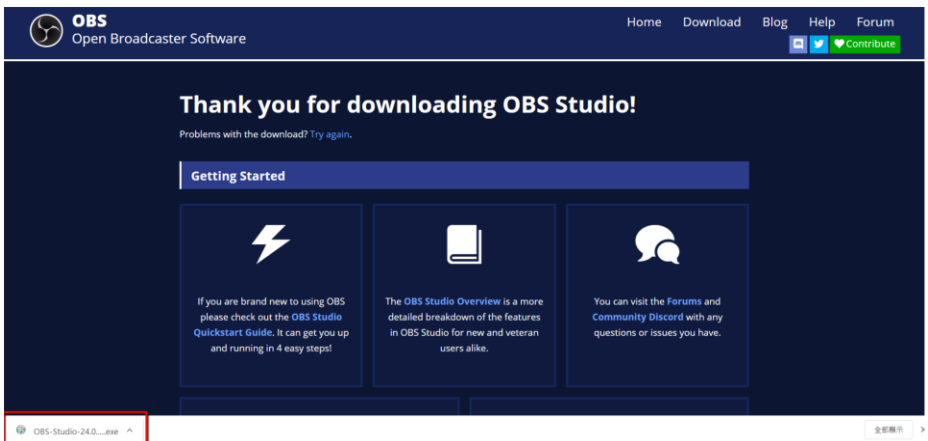

3. Please press the “Next” button for starting the installation.

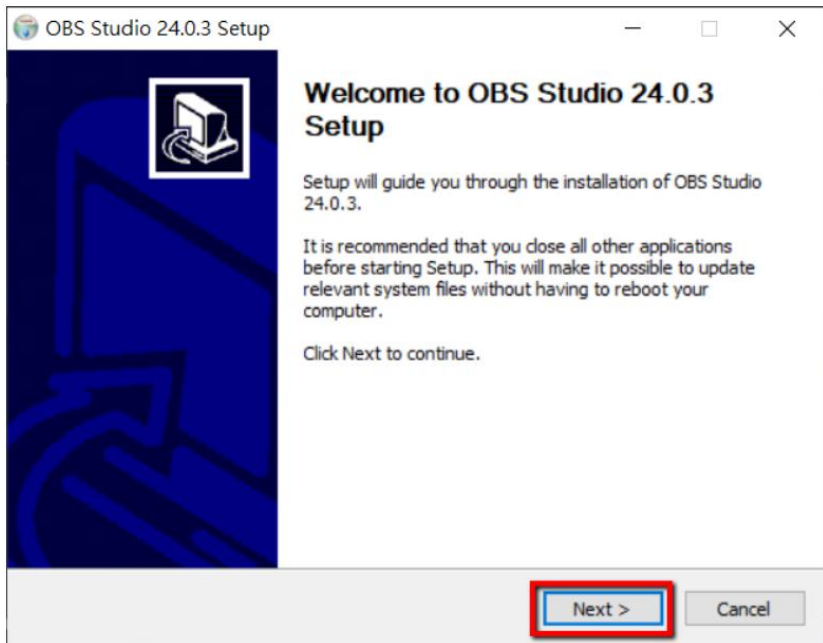

4. Please press the “I Agree” button.

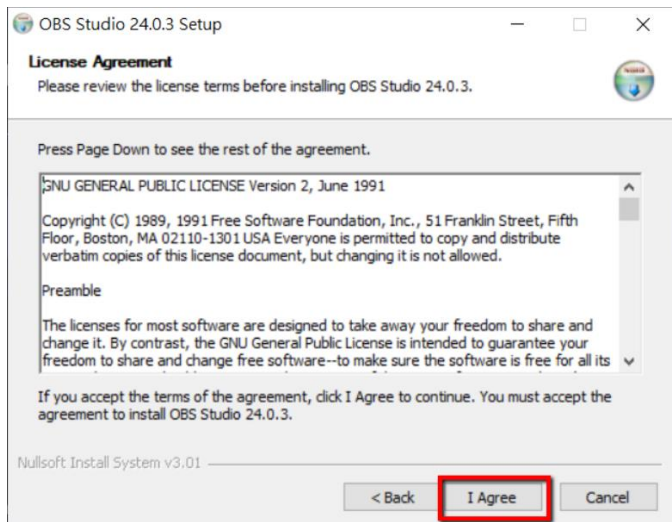

5. Please press the “Next” button.

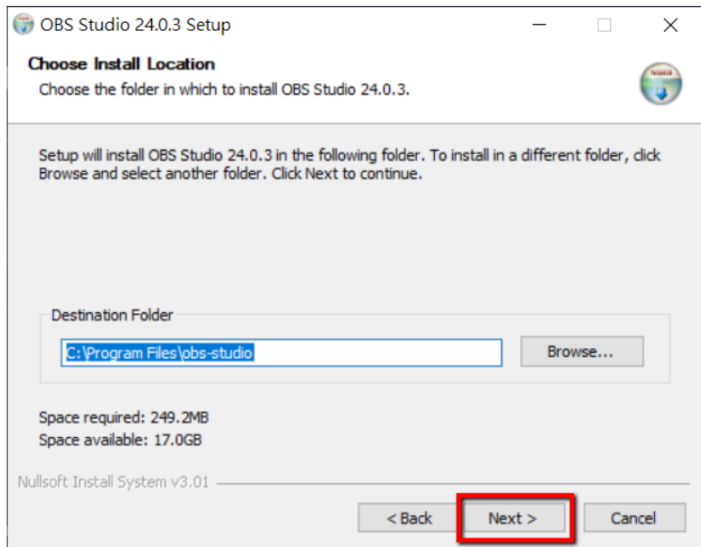

6. Please press the “Install” button.

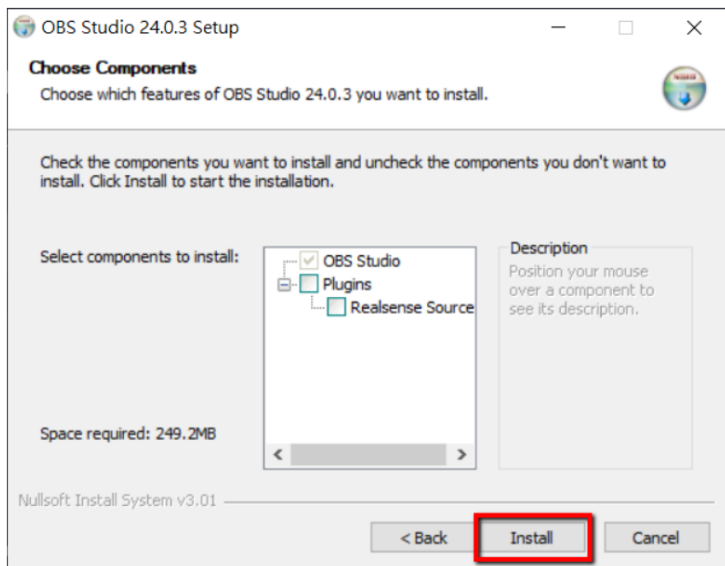



7. Users can see that the installation of the OBS software is started.

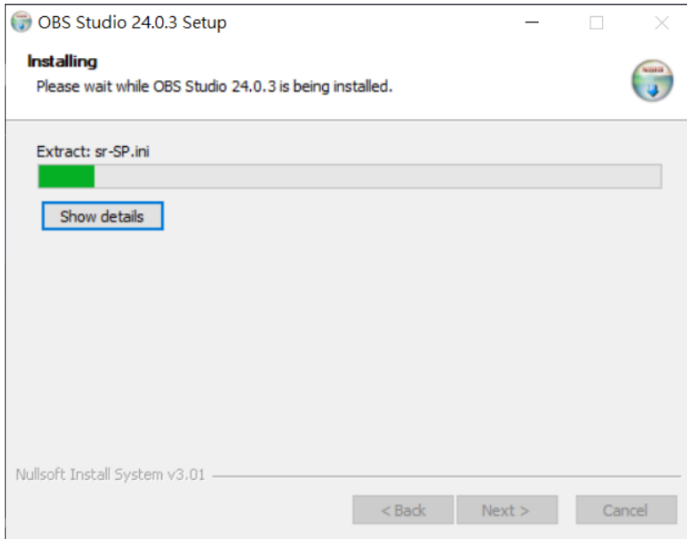

8. Please press the “Finish” button for completing the installation.

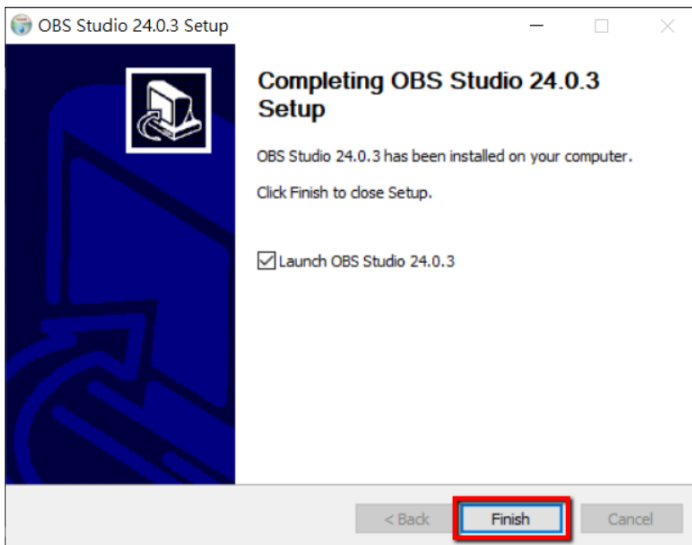

9. After the installation is finished, users can see the main interface of the software which is shown as following diagram.

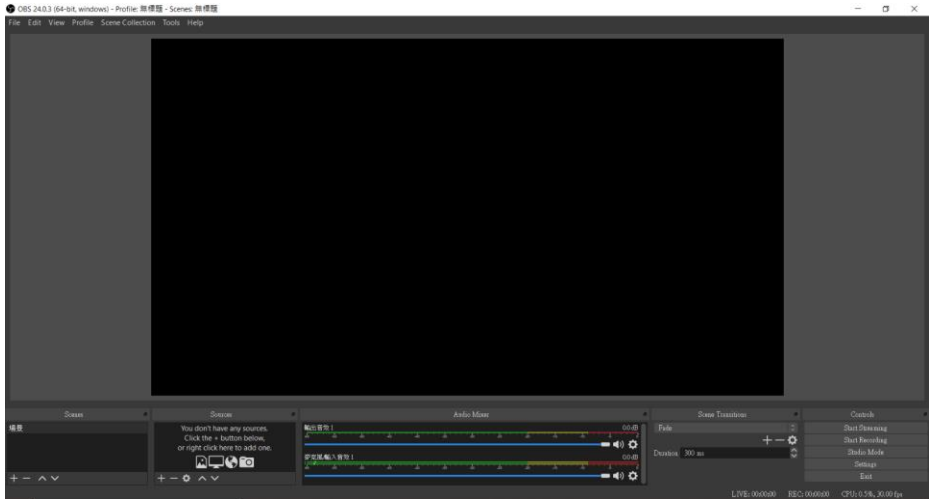

## 4.2 How to Set the Video and Audio of the OBS Streaming Software

Please follow following steps for setting the video and audio of the OBS streaming software.

### Video Setup

1. At first, please click the OBS icon for opening the OBS software.

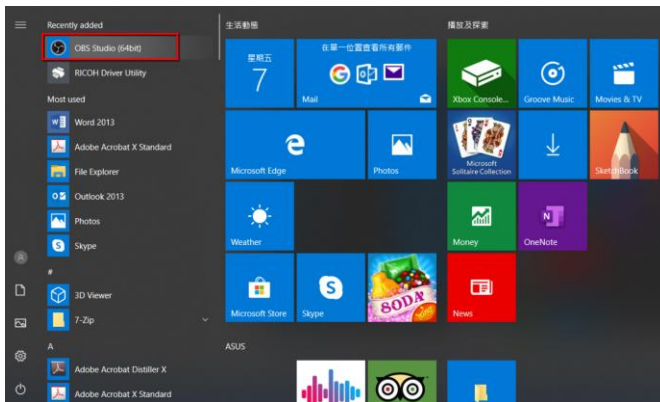

2. Users can see the main interface of the OBS software.

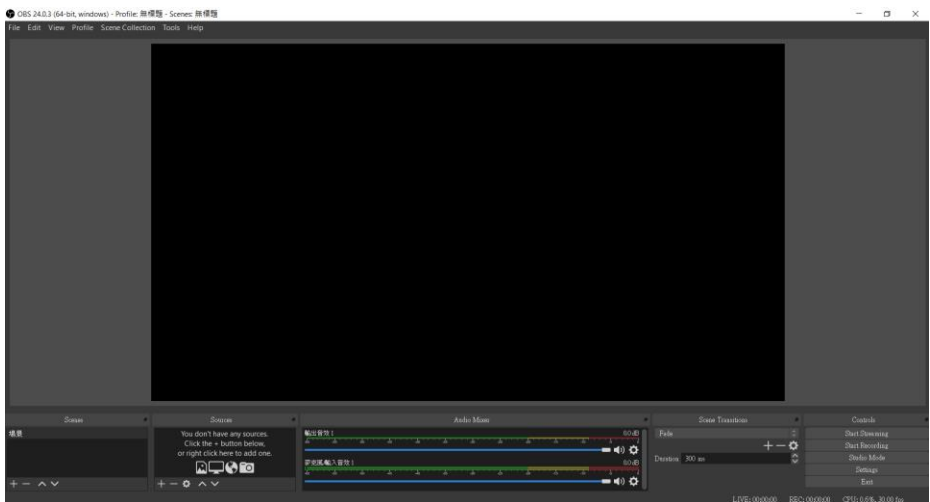

3. Please press the “Add” button  from the “Source” pane to open the “Source” menu.

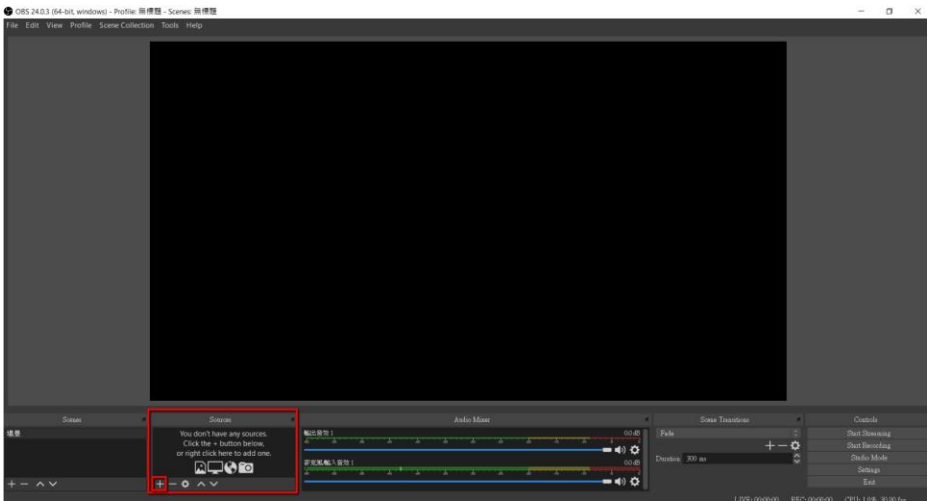

- Audio Input Capture
- Audio Output Capture
- Browser
- Color Source
- Display Capture
- Game Capture
- Image
- Image Slide Show
- Media Source
- Scene
- Text (GDI+)
- VLC Video Source
- Video Capture Device
- Window Capture
- Group
- Deprecated

#### 4. Please select “Video Capture Device” option.

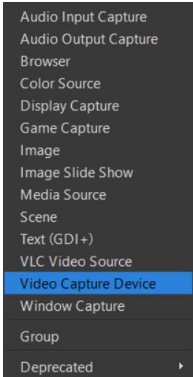

5. There is a “Create/Select Source” popup window that will be shown for users to name the video source. Please press the “OK” button. It is recommended that the “Make source visible” checkbox must be checked.

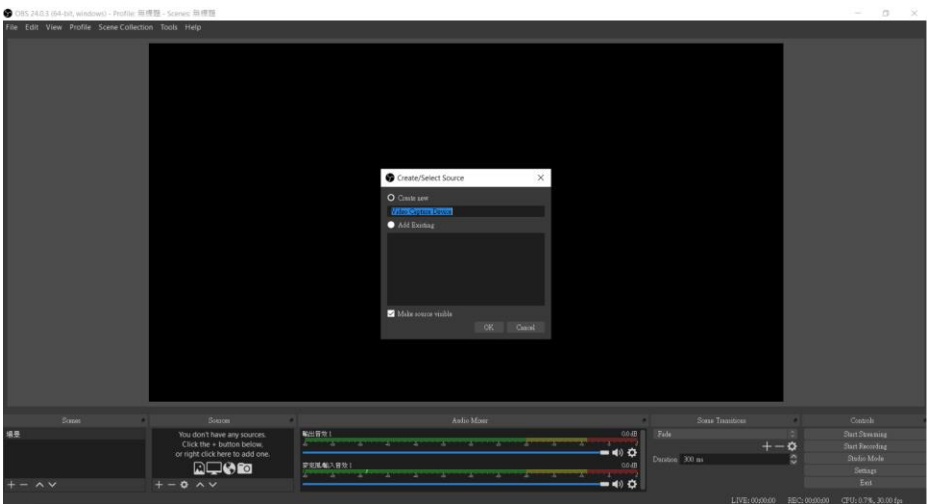

6. There is a “Properties for ‘Video Capture Device’” popup window that will be shown. Please select “CAP USB3.0 CAPTURE DEVICE”, which is the CAP-1, from the “Device” drop-down menu to be the streaming video capturing device.

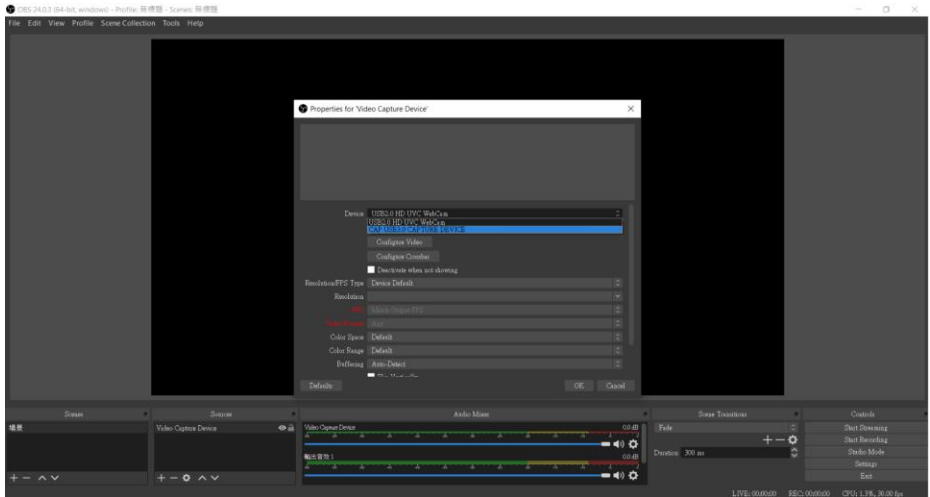

7. After the device is selected, users can see the captured screen which is shown as following diagram. Please press the “OK” button.

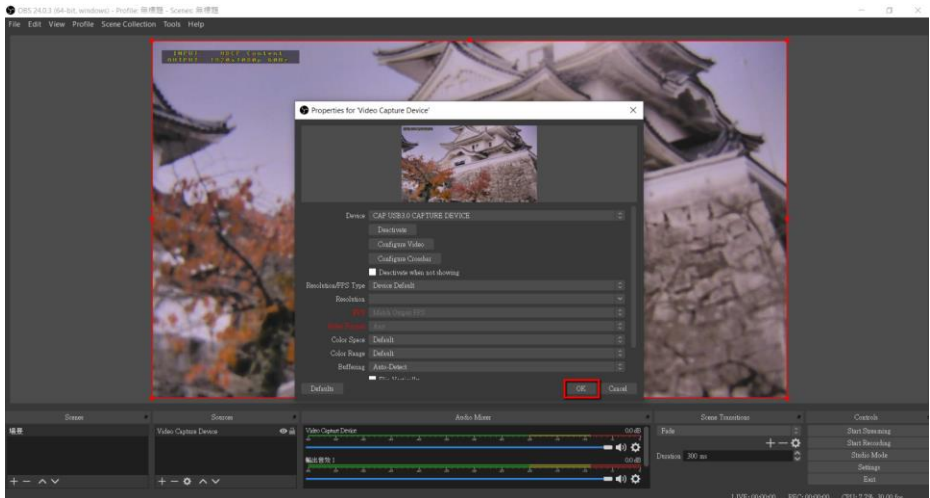

8. Please press the “OK” button and then the following screen will be shown.



## Audio Setup

Please follow following steps for setting the audio of the OBS streaming software.

- Use the Embeddd Audio of the HDMI video input source.

1. Please press the “Add” button  from the “Sources” pane to open the “Source” menu.

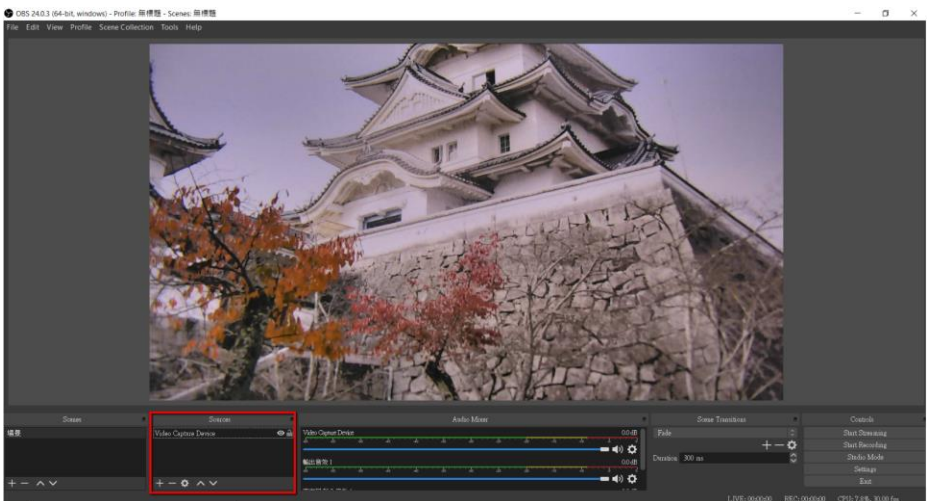

2. Please select “Audio Input Capture” option.

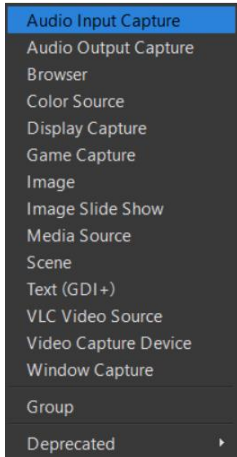

3. There is a “Create/Select Source” popup window that will be shown for users to name the audio source. Please press the “OK” button. It is recommended that the “Make source visible” checkbox must be checked.

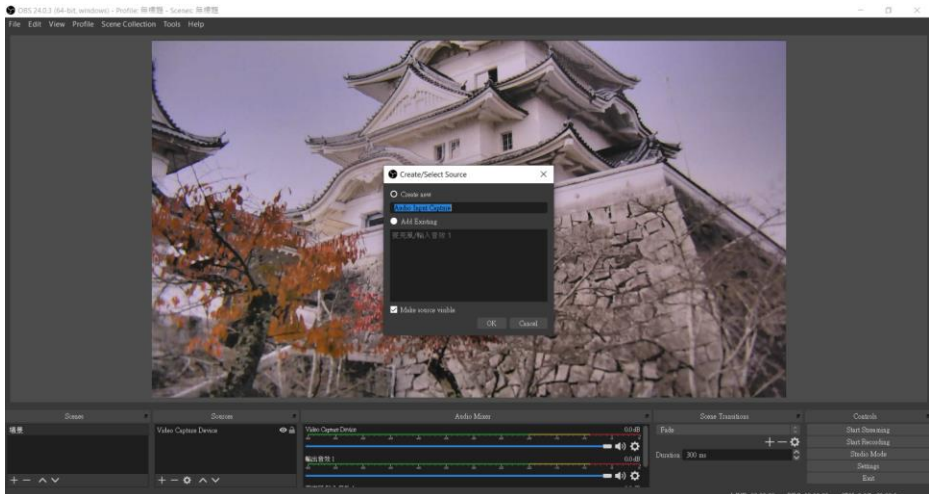



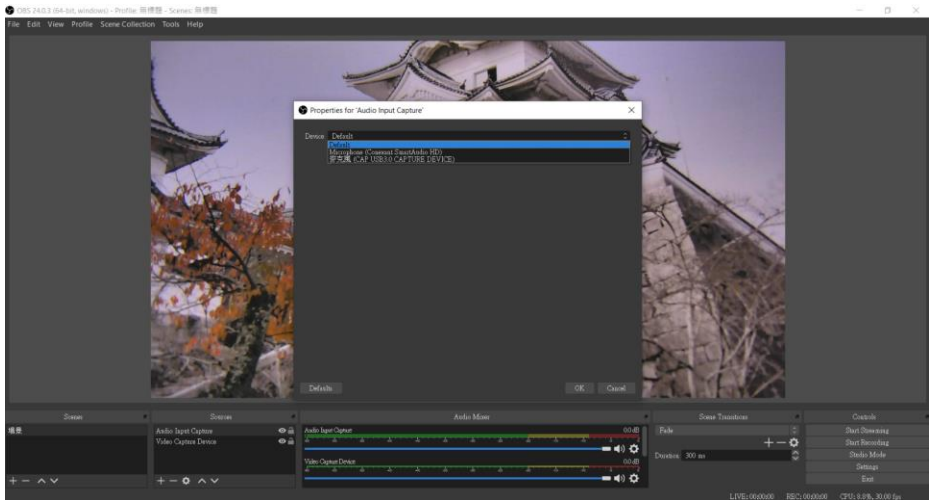

4. There is a “Properties for ‘Audio Input Capture’” popup window will be shown. Please select “Default”, which is the CAP-1, from the “Device” drop-down menu to be the streaming audio capturing device.

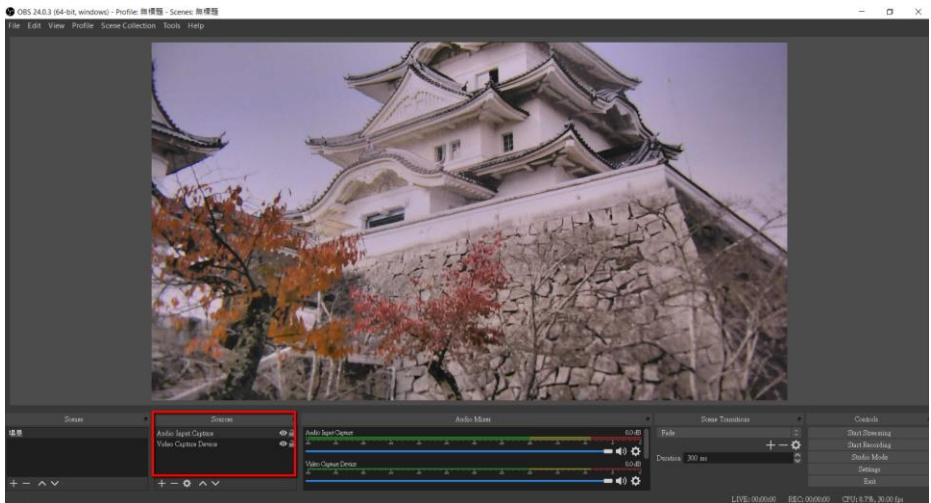

5. Users can see that the video and audio sources are successfully set in the OBS main interface which is shown as following diagram.



- Use CAP-1 external Connected Audio Source

1. Please press the “Add” button  from the “Source” pane to open the “Sources” menu.

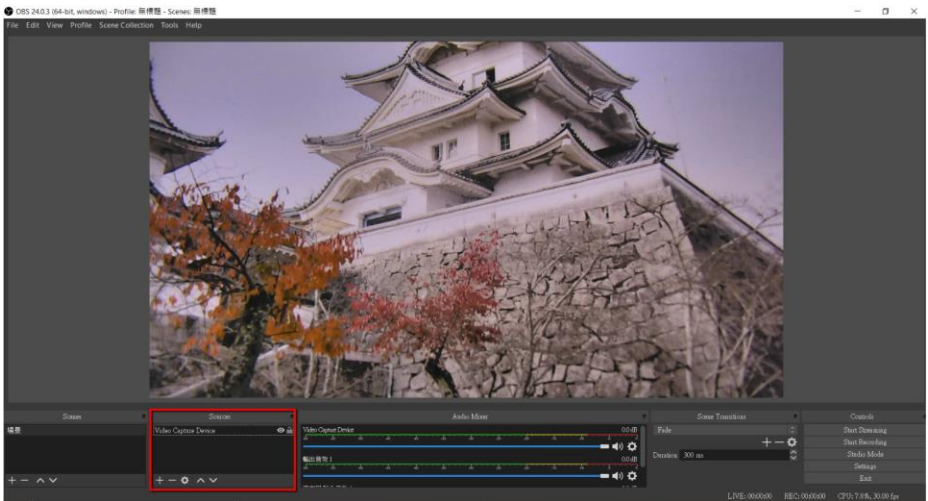

2. Please select “Audio Input Capture” option.

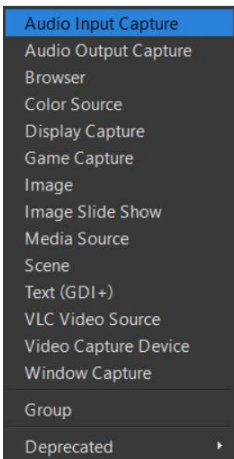

3. There is a “Create/Select Source” popup window that will be shown for users to name the audio source. Please press the “OK” button. It is recommended that the “Make source visible” checkbox must be checked.

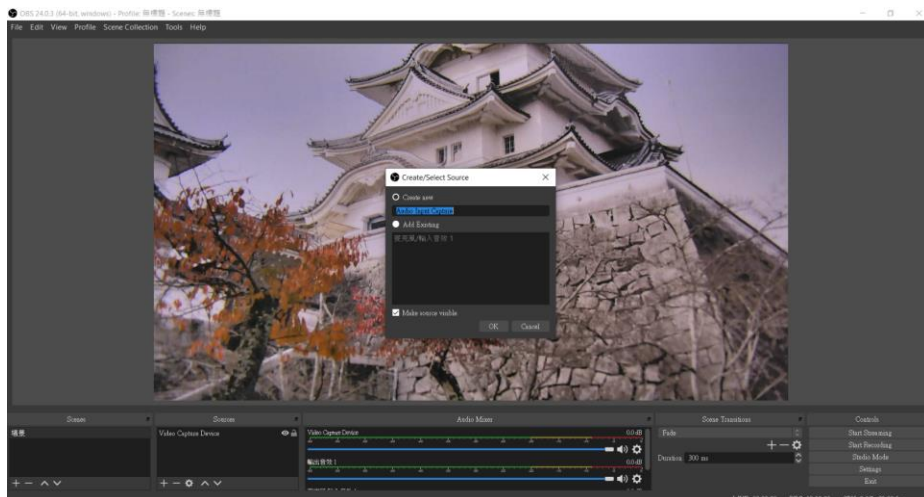

4. There is a “Properties for ‘Audio Input Capture’” popup window will be shown. Please select “麥克風(CAP USB 3.0 CAPTURE DEVICE)”, which is the CAP-1, from the “Device” drop-down menu to be the streaming audio capturing device.

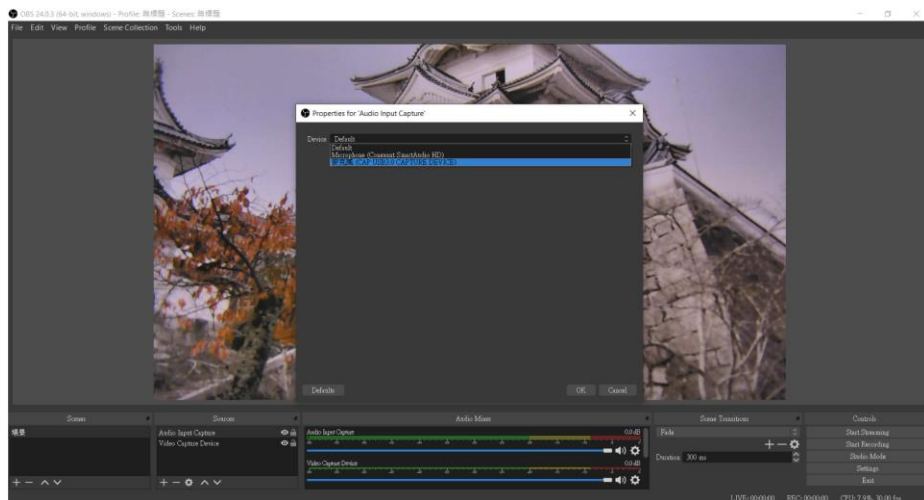

5. Users can see that the video and audio sources are successfully set in the OBS main interface which is shown as following diagram.



**Note:** For the detailed operating instructions for the recording and streaming related functions of the OBS software, please refer to the OBS website <https://obsproject.com/wiki/>

**OBS**  
Open Broadcaster Software

Home Download Blog Help Forum

Contribute

## Wiki

OBS Studio is free and open source software for video recording and live streaming. Currently Linux, Mac and Windows Builds are available.

- Official OBS Studio Builds: <https://github.com/obsproject/obs-studio/releases>
- Building OBS Studio Manually: [Install Instructions](#)

If you're looking for any kind of assistance with OBS Studio, the site has a help portal with links to resources and our support channels.

- [OBS Studio Help Portal](#)

The community has created a few guides on how to use OBS Studio:

- [Quickstart Guide: OBS Studio Quickstart](#)
- [Overview Guide: OBS Studio Overview](#)
- [Guide to Sources in Studio: Sources Guide](#)
- [Guide to Filters in Studio: Filters Guide](#)
- [General Troubleshooting Guides: Troubleshooting Guides](#)
- [Volume meters guide \(v21-\): Understanding the Mixer](#)
- [Surround sound features: Surround Sound Streaming and Recording](#)

For Support Questions, Discord, the forum and IRC are available:

- [OBS Studio Discord](#)
- [OBS Studio Forum](#)

## Home

### Guides/Info

- [System Requirements](#)
- [Launch Parameters](#)
- [Quickstart Guide](#)
- [Overview Guide](#)
- [Sources Guide](#)
- [Filters Guide](#)
- [Keyboard Shortcuts](#)
- [Surround Sound Streaming and Recording](#)
- [Understanding the Mixer](#)
- [Troubleshooting Guides](#)
  - [Known Conflicts](#)
  - [Dropped Frames](#)
  - [Buffering](#)
  - [Laptop performance/black screen](#)
  - [Performance and Encoding Issues](#)
  - [GPU Overload Issues](#)
  - [How to enable or disable Aero in Windows 7](#)
  - [How to disable Windows 10 Gaming Features](#)

## 5. Firmware Update

Please follow following steps for updating the firmware for CAP-1.

### Requirements

- a) CAP-1 x 1
- b) Notebook PC x 1
- c) USB 3.0 Cable x 1 (Please use the cable which is bundled with the CAP-1)
- d) Application Software: UVC V1.3



- e) Latest Firmware
  - CAP-1\_Main\_Vx.x.bin
  - CAP-1\_Capture\_Vx.x.bin

## System Diagram



Please follow following steps for updating the CAP-1 firmware.

## Firmware Update Procedure

### ● Main Firmware Update

1. Please connect an USB 3.0 cable from CAP-1 to your laptop.

2. Users can see the connected CAP-1 from the “Device Manager” of the Windows OS.

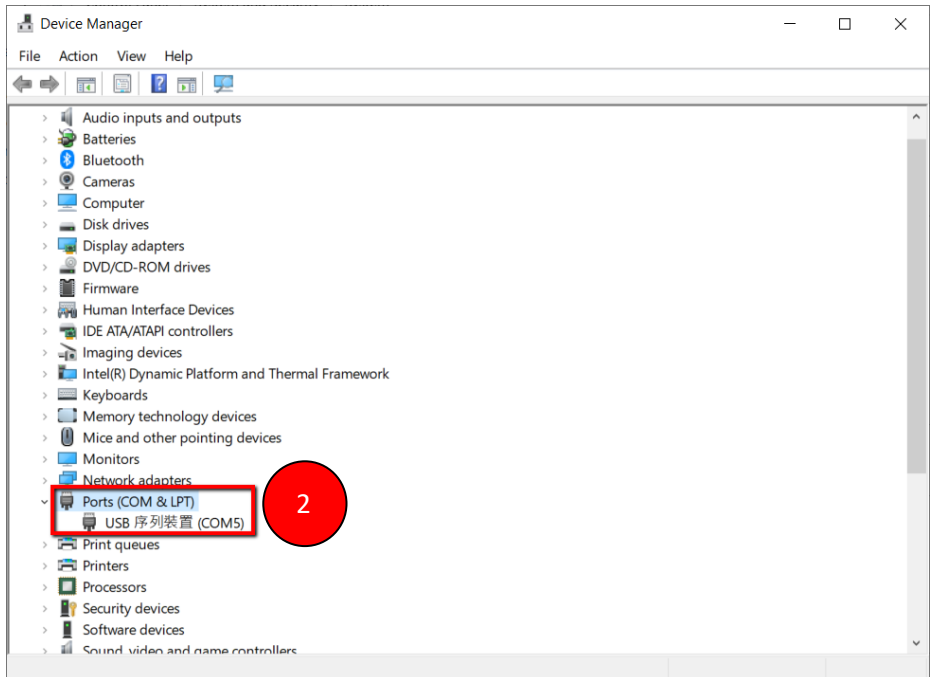



3. Please double-click to open the CAP-1 application software “UVC V1.3”.



4. Please select the correct COM port.

5. Please click the “Read” button.

6. Please click the “Main Updated” button.

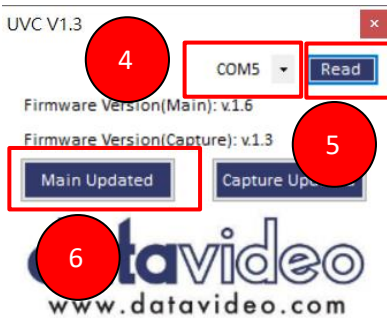

7. Please press the “Connect” button.

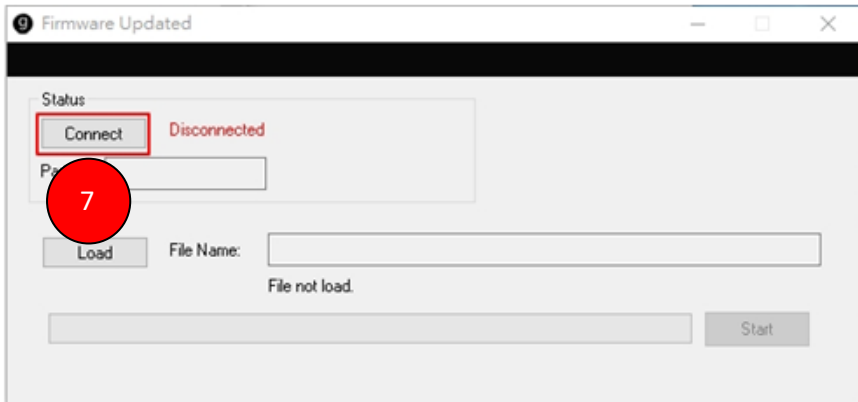

8. Please re-plug the USB cable and then please press the “Load” button to load the “CAP-1\_Main\_VX.X.bin” file.



 CAP-1\_Capture\_V1.3.bin

9. Please press the “Start” button and then please wait until the progress bar reaches 100%, the firmware update procedure is finished. After the “Programming flash,OK!” pop-up window is shown, please press the “OK” button.

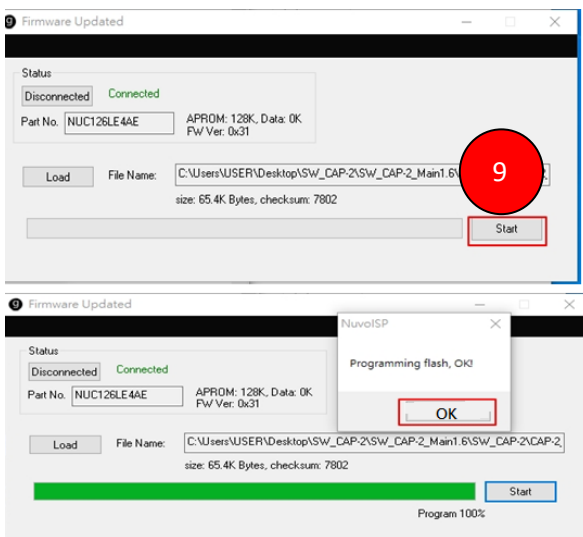

10. After the firmware update procedure is finished, users can see the latest firmware version No. which is shown as following diagram.



### ● Capture Firmware Update

Please follow following steps for updating the Capture firmware.

1. Please re-plug the USB 3.0 cable.
2. Please launch the “UVC” software.
3. Please select correct COM port.
4. “Please press the “Capture Updated” button.

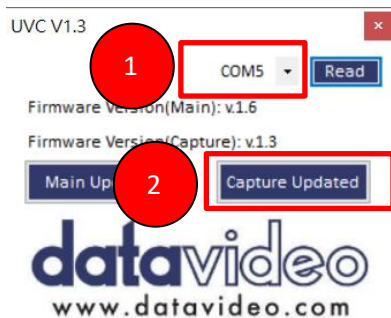

5. Please wait until the two green sentences “Burn Pass” are shown.

```
C:\WINDOWS\system32\cmd.exe
CheckParameter, FUNCTION_BURN_BIN_FILE
Found device: CAP USB3.0 CAPTURE DEVICE [\\?\usb#vid_1e4e&pid_7016&mi_00#7&4518fe1&0&0000#(65e8773d-8f56-11d0-a3b9-00a0c9223196)\global]
BurnBinFile: index: 0

Burning - SPI ROM Access

BinFileLength 49152
Erase Bin file ...

Write Bin file to ROM
[OffsetStart : OffsetEnd] 45056 : 49152
Burn Pass

C:\Users\USER\Desktop\SW_CAP-2\capture\HW_FW_DESC>cd..
C:\Users\USER\Desktop\SW_CAP-2\capture>call 04_Burn_SERIAL.bat
C:\Users\USER\Desktop\SW_CAP-2\capture>cd HW_FW_DESC\
C:\Users\USER\Desktop\SW_CAP-2\capture\HW_FW_DESC-P2ndRomMisc_v4.0.1.1.exe SER 123456789abcde SPI_25L12835F.cfg
Found device: CAP USB3.0 CAPTURE DEVICE [\\?\usb#vid_1e4e&pid_7016&mi_00#7&4518fe1&0&0000#(65e8773d-8f56-11d0-a3b9-00a0c9223196)\global]
SET_SERIAL_NUM: index: 0

Modify - SPI ROM Access

Erase Misc sector ...
[OffsetStart : OffsetEnd] 45056 : 45096
Burn Pass

C:\Users\USER\Desktop\SW_CAP-2\capture\HW_FW_DESC>pause
請按任意鍵繼續 . . .
```

6. The firmware update procedure for the Capture function is finished.

7. After the firmware update procedure is finished, users can check the Capture firmware version which is shown as following diagram.

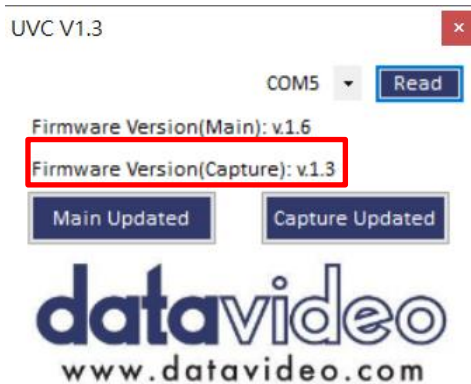

## 6. Dimensions

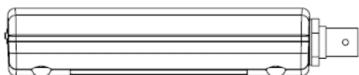
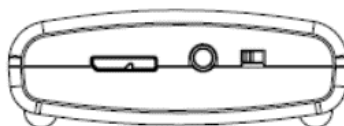
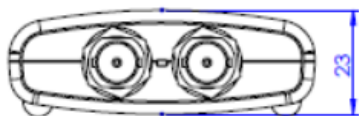
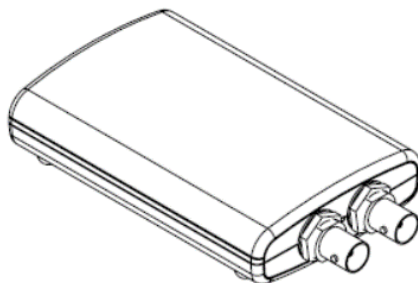
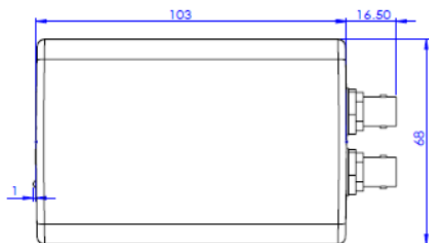

Unit: mm

## 7. Frequently-Asked Questions

This section describes problems that you may encounter while using the CAP-1. If you have questions, please refer to related sections and follow all the suggested solutions. If problem still exists, please contact your distributor or the service center.

No.	Problems	Solutions
1.	<b>Why the CAP-1 SDI to USB 3.0 Capture Box can not be detected?</b>	Please make sure that the OS system of your computer is qualified for the CAP-1 application. Please refer to the OS versions which are listed in the Specifications. Moreover, please make sure that the USB 3.0 connector of your Laptop can supply up to 900mA current.
2	<b>Why the USB 3.0 Cable cannot be detected?</b>	Please use the USB 3.0 cable which is supplied by Datavideo.

3

**If there is no audio, how to check whether the audio setting of the OS is 48KHz or not?**

Please follow following steps for confirming the audio settings of the OS (For Windows 10)

1. Please search “Settings”.



2. Please select “System”.

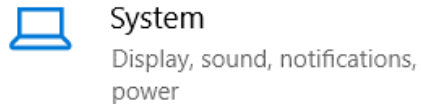

3. Please click “Sound” button.

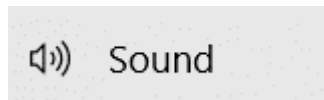

4. Please click the “Sound Control Panel” which is located at the top-right side.



5. Please click “Recording”, and then please click Microphone “CAP USB3.0 CAPTUR DEVICE”.

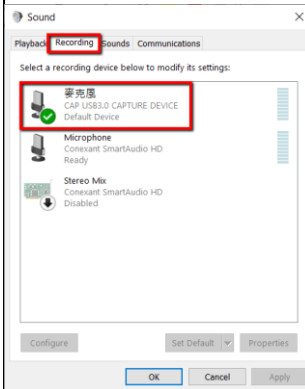

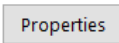

6. Please click “Properties”.

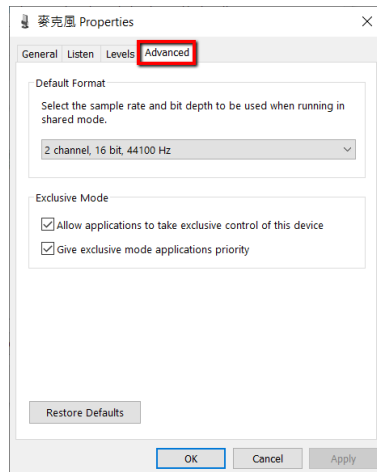

7. Please click “Advanced”.

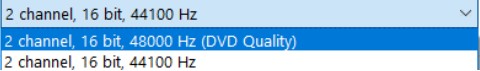

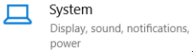
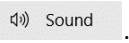
		<p>8. Users can check the recording sampling rate of the CAP-1 external connected microphone. Moreover, users can select the sampling rate from the drop-down menu.</p> 
<p>4</p>	<p><b>How to solve the issue that the Audio level is too low?</b></p>	<p>When the audio level is too low, please confirm that whether the audio level setting of your PC is 100 or not. Please follow following steps for confirming the audio level.</p> <ol style="list-style-type: none"> <li>1. Please click “Settings”  button from the Start Menu of the Windows OS (Take Windows 10 as an example).</li> <li>2. Please click “System” .</li> <li>3. Please click “Sound” .</li> </ol>

4. Please click “Sound Control Panel” option [Sound Control Panel](#) , and then the Sound Control Panel will be shown as following diagram, please click the “Recording” button.

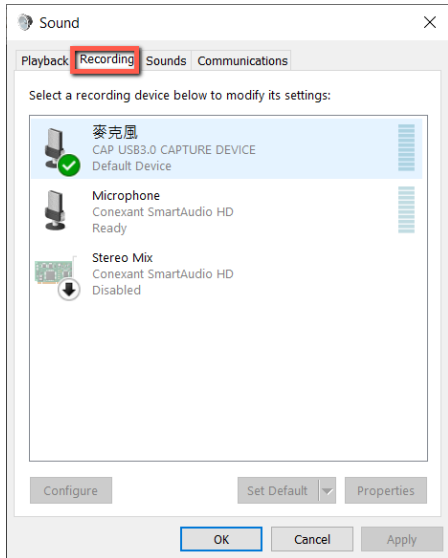

5. Please double-click “CAP USB3.0 CAPTURE DEVICE” option.

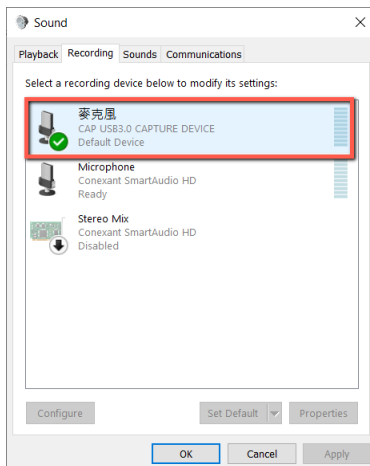

6. Please click the “Levels” button and then adjust the sound level to 100 by the slider.

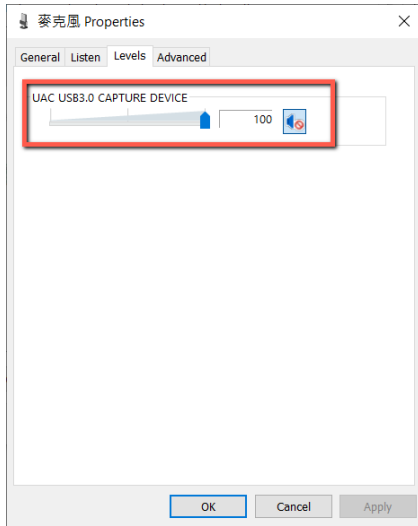

## 8. Specifications

Interface	
<b>Video Input</b>	<ul style="list-style-type: none"> <li>• HD/3G-SDI x 1</li> </ul>
<b>Video Output</b>	<ul style="list-style-type: none"> <li>• USB 3.0 x1</li> <li>• SDI Loophrough x 1</li> </ul>
<b>Input Video Bandwidth</b>	<ul style="list-style-type: none"> <li>• 150MHz (pixel clock rate)</li> </ul>
<b>Output Video Bandwidth</b>	<ul style="list-style-type: none"> <li>• Up to 350Mbps (USB)</li> </ul>
<b>Supported Input VideoFormats</b>	1920 x 1080p 60/59.94/50/30/29.97/25/24/23.976 1280 x 720p 60/59.94/50
<b>Supported Output Video Formats</b>	1920 x 1080p 60/59.94/50/30/29.97/25/24/23.976 1280 x 720p 60/59.94/50
<b>Audio Input</b>	SDI Embedded Audio & AUDIO IN Stereo
<b>Audio Sampling</b>	2 Channel, up to 16 bit PCM
<b>Captured Video Format</b>	YUY2 (USB3.0), MJPG (USB2.0/3.0)
<b>Firmware Update</b>	Via USB
Others	
<b>Software Compatibility</b>	<ul style="list-style-type: none"> <li>• Windows OS: OBS (Open Broadcast Software), Amcap, Google Plus Hangouts, Skype, VLC, Xsplit Broadcaster, Zoom.us</li> <li>• Mac OS X : OBS, Quicktime player, VLC, Facetime</li> <li>• Linux OS: VLC, OBS</li> </ul>
<b>Supported Operating System</b>	<ul style="list-style-type: none"> <li>• Windows® 7(SP1)</li> <li>• Windows 10</li> <li>• Windows 8.1</li> <li>• Windows 7(x86, x64)</li> <li>• OS X (10.10 or above)</li> <li>• Linux Ubuntu 14.04</li> </ul>
<b>Power Supply</b>	Via USB
<b>Power Consumption</b>	3W
<b>Operating Temperature</b>	0~40°C (32~104°F)
<b>Storage Temperature</b>	-20~60°C (-4~140°F)
<b>Humidity</b>	20~90% RH (Non-Condensing)
<b>Mnimum System Requirements</b>	<ul style="list-style-type: none"> <li>• Windows® 7(SP1) / Windows 10 /</li> </ul>

	<p>Windows 8.1 / Windows 7 (x86, x64)</p> <p><b>Note: Driver is needed for Windows 7</b></p> <ul style="list-style-type: none"> <li>● MAC OS X (10.10 or higher)</li> <li>● Linux Ubuntu 14.04</li> <li>● PC: Intel® Core™ i5-4440 3.10GHz + NVIDIA® GeForce® GTX 660 or higher</li> <li>● Notebook PC: Intel® Core i7-4810MQ + NVIDIA GeForce GTX 870M or higher , 4GB RAM or higher</li> </ul>
<b>Dimensions</b>	105 (L) x 68 (D) x 23 (H) mm
<b>Weight</b>	0.07KG

## Note

## Service & Support

It is our goal to make your products ownership a satisfying experience. Our supporting staff is available to assist you in setting up and operating your system. Please refer to our web site [www.datavideo.com](http://www.datavideo.com) for answers to common questions, support requests or contact your local office below.



Please visit our website for latest manual update.  
<https://www.datavideo.com/product/CAP-1>

**datavideo**  
[www.datavideo.com](http://www.datavideo.com)



@DatavideoUSA @DatavideoIndia2016  
@DatavideoEMEA @Datavideojapan  
@DatavideoTaiwan @DatavideoLatam  
@DatavideoAsia @DatavideoBrasil



@Datavideo  
@Datavideo\_EMEA  
@Datavideo\_Taiwan



@DatavideoUSA  
@DVTWDCVN



@DatavideoUSA  
@DatavideoEurope

All the trademarks are the properties of their respective owners.  
Datavideo Technologies Co., Ltd. All rights reserved 2020