

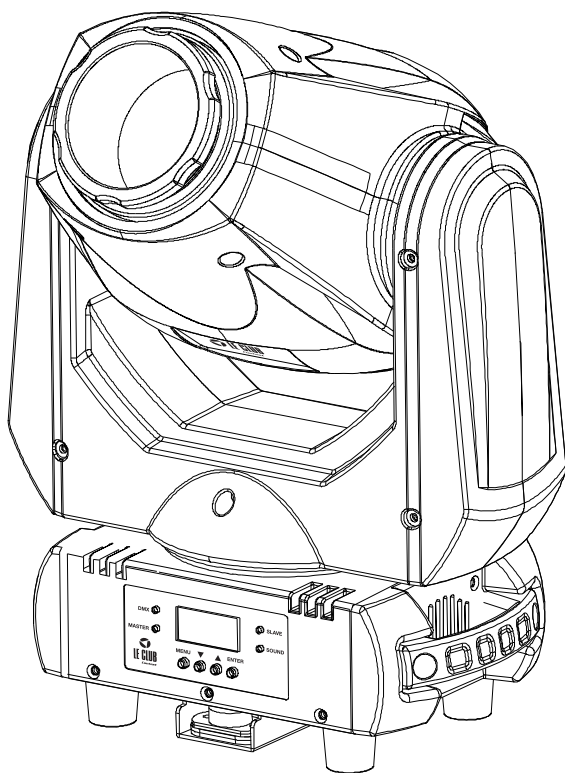

80W SPOT MOVING HEAD



CYCLONE-80

USER GUIDE
10175 - 1 April 2014 version

1 - Safety information

Important safety information



This unit is intended for indoor use only. Do not use it in a wet, or extremely cold/hot locations. Failure to follow these safety instructions could result in fire, electric shock, injury, or damage to this product or other property.



Any maintenance procedure must be performed by a CONTEST authorised technical service. Basic cleaning operations must thoroughly follow our safety instructions.



This product contains non-isolated electrical components. Do not undertake any maintenance operation when it is switched on as it may result in electric shock.

Symbols used



This symbol signals an important safety precaution.



The WARNING symbol signals a risk to the user's physical integrity. The product may also be damaged.



The CAUTION symbol signals a risk of product deterioration.

Instructions and recommendations

1 - Please read carefully :

We strongly recommend to read carefully and understand the safety instructions before attempting to operate this unit.

2 - Please keep this manual :

We strongly recommend to keep this manual with the unit for future reference.

3 - Operate carefully this product :

We strongly recommend to take into consideration every safety instruction.

4 - Follow the instructions:

Please carefully follow each safety instruction to avoid any physical harm or property damage.

5 - Avoid water and wet locations :

Do not use this product in rain, or near washbasins or other wet locations.

6 - Installation :

We strongly encourage you to only use a fixation system or support recommended by the manufacturer or supplied with this product. Carefully follow the installation instructions and use the adequate tools.

Always ensure this unit is firmly fixed to avoid vibration and slipping while operating as it may result in physical injury.

7 - Ceiling or wall installation :

Please contact your local dealer before attempting any ceiling or wall installation.

8 - Ventilation :

The cooling vents ensure a safe use of this product, and avoid any overheating risk. Do not obstruct or cover these vents as it may result in overheating and potential physical injury or product damage. This product should never be operated in a closed non-ventilated area such as a flight case or a rack, unless cooling vents are provided for the purpose.

WARNING : This unit contains no user-serviceable parts. Do not open the housing or attempt any maintenance by yourself. In the unlikely even your unit may require service, please contact your nearest dealer.



CAUTION
RISK OF ELECTRIC SHOCK
DO NOT OPEN



In order to avoid any electrical malfunction, please do not use any multi-socket, power cord extension or connecting system without making sure they are perfectly isolated and present no defect.



Warning

This product is equipped with Class 2 LEDs.

Please avoid looking directly at the beam as it may cause severe eye injuries.

Recycling your device



- As HITMUSIC is really involved in the environmental cause, we only commercialise clean, ROHS compliant products.
- When this product reaches its end of life, take it to a collection point designated by local authorities. The separate collection and recycling of your product at the time of disposal will help conserve natural resources and ensure that it is recycled in a manner that protects human health and the environment.

9 - Heat exposure :

Sustained contact or proximity with warm surfaces may cause overheating and product damages. Please keep this product away from any heat source such as a heaters, amplifiers, hot plates, etc...

10 - Electric power supply :

This product can only be operated according to a very specific voltage. These information are specified on the label located at the rear of the product.

11 - Power cords protection:

Power-supply cords should be routed so that they are not likely to be walked on or pinched by items placed upon or against them, paying particular attention to cords at lugs, convenience receptacles and the point where they exit from the fixture.

12 - Cleaning precautions :

Unplug the product before attempting any cleaning operation. This product should be cleaned only with accessories recommended by the manufacturer. Use a damp cloth to clean the surface. Do not wash this product.

13 - Long periods of non use :

Disconnect the unit's main power during long periods of non use.

14 - Liquids or objects penetration :

Do not let any object penetrate this product as it may result in electric shock or fire. Never spill any liquid on this product as it may infiltrate the electronic components and result in electric shock or fire.

15 - This product should be serviced when :

- Please contact the qualified service personnel if :
- The power cord or the plug has been damaged.
 - Objects have fallen or liquid has been spilled into the appliance.
 - The appliance has been exposed to rain or water.
 - The product does not appear to operate normally.
 - The product has been damaged.

16 - Inspection/maintenance :

Please do not attempt any inspection or maintenance by yourself. Refer all servicing to qualified personnel.

17 - Operating environment :

Ambient temperature and humidity: +5 - +35°C, relative humidity must be less than 85% (when cooling vents are not obstructed).
Do not operate this product in a non-ventilated, very humid or warm place.

2 - Technical specifications

Light source

- › 80W CW LED - 50 000 hours (expected)
- › Dual lens with manual zoom
- › Beamwidth: 15°
- › Low temperature, low power consumption, can be operated non-stop for many hours

Effects

- › Adjustable strobe, random strobe and pulse effect
- › 3-facet rotating prism with variable speed
- › 1 colour wheel with 8 colours+open per dichroic filter
- › 1 gobo wheel with 7 gobos+open
- › Semi-colour macros
- › Gobo shake function
- › Adjustable electronic dimmer: 0-100%

Control

- › Standard DMX-512
- › 1-15 DMX channels
- › Simplified controls (EASY-2 Compatible)
- › Built-in music-sensitive programs (via the internal mic)
- › Simplified controls of several units (with the Master/Slave mode)
- › Drop-down display to assign and choose the different modes

Movements

- › PAN and TILT movements
- › Movement range: Pan 540°, Tilt 270°
- › Positioning memory, Pan and Tilt auto repositioning

Additional characteristics

- › Adjustable fan speed
- › Omega fixation system
- › Power consumption : 150W max.
- › Power supply : 100/230V - 50/60Hz, AC
- › Dimensions : 292 x 169 x 425 mm
- › Net weight : 8 Kg

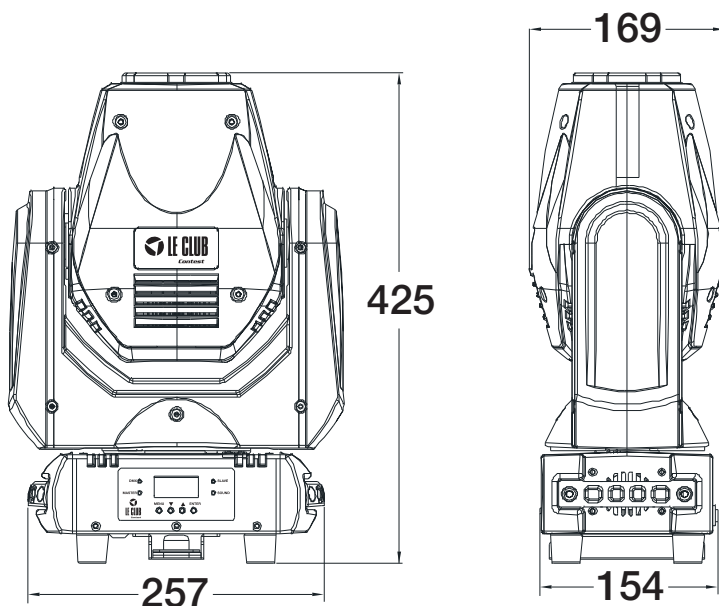

3 - Description

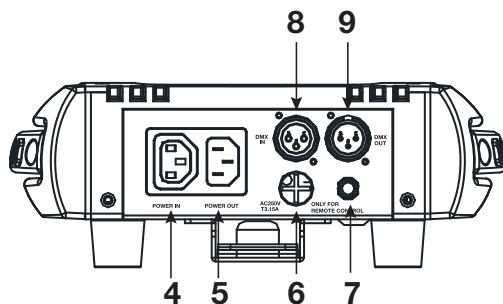
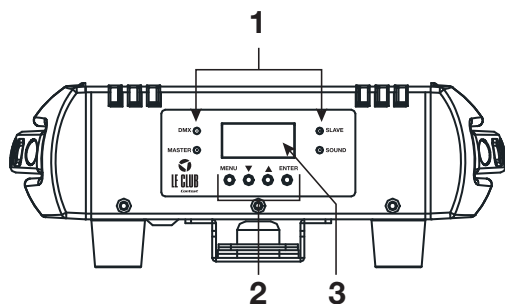

1 Indicator LEDs

These 4 LEDs indicate the device status.

LED	Indication
DMX	Is ON when the DMX mode is activated
MASTER	is ON when the Master mode is activated
SLAVE	is ON when the Slave mode is activated
SOUND	Flashes when the Sound-sensitive mode is activated

2 Menu settings

MENU

Press MENU to access and select the functions.

ENTER

Press ENTER to access a sub-menu and or save changes selected via the UP and DOWN buttons.

UP and DOWN

Press UP or DOWN to increase/decrease the adjustable values or browse the sub-menus.

3 Display

This intuitive display allows you to configure your projector. Please refer to the next paragraphs for more details about the projector configuration. The display backlight can be deactivated via the Back Light command menu.

4 Power input

Allows you to connect the projector to an electrical outlet. Please make sure the voltage is in adequation with the product indications.

5 Power output socket

Allows you to link two projectors together via a Male/Female IEC cord. You can daisy chain up to 8 projectors.

6 Fuse

If need to replace the fuse, please make sure the new fuse has exactly the same characteristics as the original one.

7 Stereo Jack 6.35 input

This input allows you to plug in the EASY-2 optional remote control.

Only the EASY-2 remote control should use this input, as plugging other devices may result in severe damages to the internal electrics.

8 DMX input

3-pin female XLR plug hardwired as follows :

- Mass: 1
- Negative signal: 2
- Positive signal: 3

9 DMX output

3-pin male XLR plug hardwired as follows :

- Mass: 1
- Negative signal: 2
- Positive signal: 3











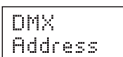

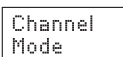



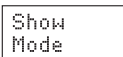

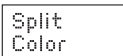

4 - Internal menu

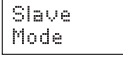
4.1 - Menus and functions

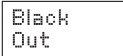
Once turned on, the moving head will start a position initialisation for each motor. At this stage, the display indicates .

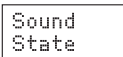
Once the initialisation is over, the display will indicate , you will then be able to access the menu using the MENU or ENTER buttons. If the

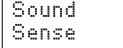
menu remains inactive for 30 seconds, the display will indicate  and locks. To access the menu again, press ENTER.

MENU	UP and DOWN	Action		ENTER
		DMX address selection Press ENTER and select the address with UP and DOWN		Saves changes
		1 channel : Select the pre-programmed sequences: 1 - 4		Press ENTER, mode selection with UP and DOWN. Saves changes
		9 channels : Pan, Tilt, Dimmer, Strobe, Colour wheel, Gobo wheel, Prism, Prism rotation, Functions		
		15 channels : Pan, Precise Pa., Tilt, Precise Tilt, Movement speed, Movement macros, VMovement macros speed, Dimmer, Strobe, Colour wheel, Gobo wheel, Prism, Prism rotation, Prism macros, Functions		
		Show 1 : PAN = 180° / TILT = 100°	Shows are music-sensitive. Please make sure the music-sensitive mode is activated (Sound State menu), and the microphone configured (Sound Sense menu). Refer to paragraph 4.3 for more details about music-sensitive shows.	Saves changes
		Show 2 : PAN = 180° / TILT = 100°		
		Show 3 : PAN = 540° / TILT = 180°		
		Show 4 : PAN = 540° / TILT = 100°		
		The Split Color mode allows you to create half-colours and full colours.		Saves changes
				
		Determines how the device reacts in Slave mode : - Slave 1 : The device replicates the Master device movements. - Slave 2 : The device replicates in reverse the Master device movements.		Saves changes
				
		Activates or deactivates the Black out mode. When ON is selected, the moving head automatically starts in black out mode when turned on. When Off is selected, the moving head automatically launches shows when turned on. Press ENTER and select On or Off with the UP and DOWN buttons.		Saves changes
				
		Activates or deactivates the music-sensitive mode. Press ENTER and select On or Off with the UP and DOWN buttons.		Saves changes
				
		Adjusts the microphone sensitivity (for music-sensitive modes) . When the value is 000, the microphone is deactivated.		Saves changes

4.1 - Menus and functions (continuation and end)

MENU	UP and DOWN	Action	ENTER
Pan Inverse	No Yes	Activates the PAN movement reversion when the Slave and Show modes are activated, or in DMX mode. Press ENTER and select Yes or No with UP and DOWN.	Saves changes
Tilt Inverse	No Yes	Activates the TILT movement reversion when the Slave mode is activated, or in DMX mode. Press ENTER and select Yes or No with UP and DOWN.	Saves changes
Back Light	On Off	Activates or deactivates the display backlight. Press ENTER and select On or Off with the UP and DOWN buttons. When Off, the display automatically turns off after a 30-second inactivity period.	Saves changes
Function Delay	No Delay 1S Delay 2S Delay 3S Delay	This functions impacts the «Special functions» DMX channel. The delay is the amount of time between the activation of a function and its execution.	Saves changes
Dimmer Calibrat	050-100	Allows you to configure the max output when the dimmer channel is at its maximum. The max attenuation is 50%.	Saves changes
Auto Test	Test...	Tests each function.	Launches the test
Temp.	xxx	Displays the temperature of the projector head (Celsius degrees).	No action
Fixture Time	xxx	Displays the total operating hours since the product was switched on for the first time.	No action
Firmware Version	A :UX.X Ab:UX.X	Displays the current software versions. A refers to the operating software. Ab refers to the booting software.	No action
Default	Confirm? Yes Confirm? No	Allows you to reset the following parameters and switch to professional mode (PRO default) or normal mode (Auto default). Non-listed functions are not impacted by this reset.	Saves changes
Reset		Resets the device.	Resets

4.2 - Initial position settings

After initialising, the moving head is automatically positioned on its original positions.

You can configure this positions as it pleases you.

Enter the DMX Address menu, then press ENTER for more than 3 seconds. You are now accessing the initial position settings.

Pan Offset	-127 +127	PAN movement initial position settings.
Tilt Offset	-127 +127	TILT movement initial position settings.
Color Offset	-127 +127	Colour wheel movement initial position settings.
Gobo Offset	-127 +127	Gobo wheel movement initial position settings.
Prism Offset	-127 +127	Prism initial position settings.
R Prism Offset	-127 +127	Prism rotation initial position settings.

4.3 - Movement limitations

In order to avoid lighting effects over untargeted areas (such as ceilings, room angles, etc.) each show has its own PAN and TILT ranges.

Show 1

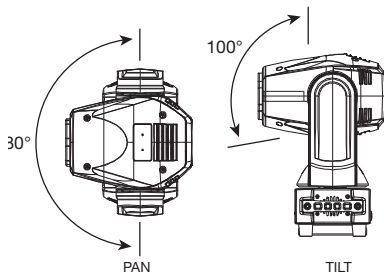

Show 2

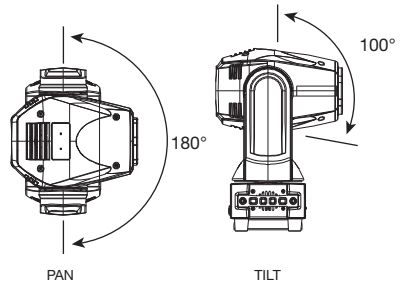

Show 3

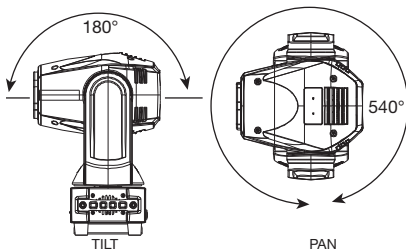

Show 4

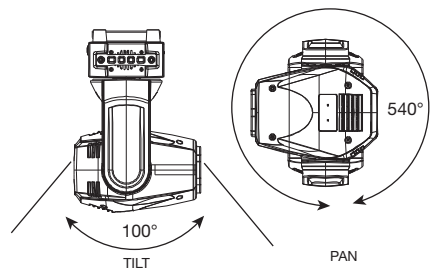

5 - The various DMX modes

As soon as a DMX signal is detected via the DMX IN input, the DMX mode is automatically activated.

5.1 - 1-channel mode

Channel	Values	Action
1	000 - 007	Black-out
	008 - 069	Show 1
	070 - 131	Show 2
	132 - 193	Show 3
	194 - 255	Show 4

5.2 - 9-channel mode

Channel	Values	Action
1	000 - 255	PAN movement
2	000 - 255	TILT movement
3	000 - 255	Main Dimmer
4		Strobe
	000 - 007	Black-out
	008 - 015	Open
	016 - 131	Strobe at increasing speed
	132 - 139	Open
	140 - 181	Pulse effect
	182 - 189	Open
	190 - 231	Reversed pulse effect
	232 - 239	Open
	240 - 247	Random strobe
248 - 255	Open	
5 Mode Normal		Colour wheel (Normal mode)
	000 - 014	White (open)
	015 - 028	Red
	029 - 042	Orange
	043 - 056	Yellow
	057 - 070	Green
	071 - 084	Blue
	085 - 098	Magenta
	099 - 112	Sky blue
	113 - 127	Pink
	128 - 189	Clockwise rainbow effect : from slow to fast
	190 - 193	No rotation
194 - 255	Counterclockwise rainbow effect: from fast to slow	
5 Mode Split		Colour wheel (Split mode)
	000 - 007	White (open)
	008 - 014	White + Red
	015 - 022	Red
	023 - 029	Red + Orange
	030 - 037	Orange
	038 - 044	Orange + Yellow
	045 - 052	Yellow
	053 - 059	Yellow + Green
	060 - 067	Green
	068 - 074	Green + Blue
	075 - 082	Blue

5.2 - 9-channel mode (continuation and end)

Channels	Values	Action
5 Split mode (continuation)	083 - 089	Colour wheel (Split mode) (continuation) Blue + Magenta
	090 - 097	Magenta
	098 - 104	Magenta + Sky blue
	105 - 112	Sky blue
	113 - 119	Sky blue + Pink
	120 - 127	Pink
	128 - 189	Clockwise rainbow effect : from slow to fast
	190 - 193	No rotation
	194 - 255	Counterclockwise rainbow effect: from fast to slow
6	000 - 007	Gobo wheel Open
	008 - 015	Gobo 1
	016 - 023	Gobo 2
	024 - 031	Gobo 3
	032 - 039	Gobo 4
	040 - 047	Gobo 5
	048 - 055	Gobo 6
	056 - 063	Gobo 7
	064 - 073	Gobo 1 shake effect
	074 - 082	Gobo 2 shake effect
	083 - 091	Gobo 3 shake effect
	092 - 100	Gobo 4 shake effect
	101 - 109	Gobo 5 shake effect
	110 - 118	Gobo 6 shake effect
	119 - 127	Gobo 7 shake effect
128 - 189	Clockwise gobos rotation : from slow to fast	
190 - 193	No rotation	
194 - 255	Counterclockwise gobos rotation: from fast to slow	
7	000 - 007	Prism No function
	008 - 255	Prism
8	000 - 127	Prism rotation 0 - 360° Indexing
	128 - 189	Clockwise rotation from slow to fast
	190 - 193	No rotation
	194 - 255	Counterclockwise rotation from fast to slow
9	000 - 069	Special functions No function
	070 - 079	Black-out during PAN and TILT movements
	080 - 089	No black-out during PAN and TILT movements
	090 - 099	Black-out during colour changes
	100 - 109	No black-out during colour changes
	110 - 119	Black-out during gobo changes
	120 - 129	No black-out during gobo changes
	130 - 199	No function
	200 - 209	Reset all
	210 - 249	No function
	250 - 255	Music-sensitive mode: shows 1 to 4 sequencing

5.3 - 15-channel mode

Channels	Values	Action
1	000 - 255	PAN movement
2	000 - 255	Precise PAN movement
3	000 - 255	TILT movement
4	000 - 255	Precise TILT movement
5	000 - 255	PAN and TILT movement speed
6		PAN and TILT macros
	000 - 007	No function
	008 - 015	Macro 1
	016 - 023	Macro 2
	024 - 031	Macro 3
	032 - 039	Macro 4
	040 - 047	Macro 5
	048 - 055	Macro 6
	056 - 063	Macro 7
	064 - 071	Macro 8
	072 - 079	Macro 9
	080 - 087	Macro 10
	088 - 095	Macro 11
	096 - 103	Macro 12
	104 - 111	Macro 13
	112 - 119	Macro 14
	120 - 127	Macro 15
	128 - 135	Macro 16
	136 - 143	Macro 17
	144 - 151	Macro 18
	152 - 159	Macro 19
	160 - 167	Macro 20
	168 - 175	Macro 21
	176 - 183	Macro 22
	184 - 191	Macro 23
	192 - 199	Macro 24
	200 - 207	Macro 25
	208 - 215	Macro 26
	216 - 223	Macro 27
	224 - 231	Macro 28
	232 - 239	Macro 29
	240 - 247	Macro 30
248 - 255	Macro 31	
7	000 - 255	PAN and TILT macros speed
8	000 - 255	General dimmer
9		Strobe
	000 - 007	Black-out
	008 - 015	Open
	016 - 131	Strobe at increasing speed
	132 - 139	Open
	140 - 181	Pulse effect
	182 - 189	Open
	190 - 231	Reversed pulse effect
	232 - 239	Open
	240 - 247	Random strobe
	248 - 255	Open

5.3 - 15-channel mode (continuation and end)

10 Normal mode		Colour wheel (Normal mode)
	000 - 014	White (open)
	015 - 028	Red
	029 - 042	Orange
	043 - 056	Yellow
	057 - 070	Green
	071 - 084	Blue
	085 - 098	Magenta
	099 - 112	Sky blue
	113 - 127	Pink
	128 - 189	Clockwise rainbow effect : from slow to fast
	190 - 193	No rotation
194 - 255	Counterclockwise rainbow effect: from fast to slow	
10 Split mode		Colour wheel (Split mode)
	000 - 007	White (open)
	008 - 014	White + Red
	015 - 022	Red
	023 - 029	Red + Orange
	030 - 037	Orange
	038 - 044	Orange + Yellow
	045 - 052	Yellow
	053 - 059	Yellow + Green
	060 - 067	Green
	068 - 074	Green + Blue
	075 - 082	Blue
	083 - 089	Blue + Magenta
	090 - 097	Magenta
	098 - 104	Magenta + Sky blue
	105 - 112	Sky blue
	113 - 119	Sky blue + Pink
	120 - 127	Pink
128 - 189	Clockwise rainbow effect : from slow to fast	
190 - 193	No rotation	
194 - 255	Counterclockwise rainbow effect: from fast to slow	
11		Gobo wheel
	000 - 007	Open
	008 - 015	Gobo 1
	016 - 023	Gobo 2
	024 - 031	Gobo 3
	032 - 039	Gobo 4
	040 - 047	Gobo 5
	048 - 055	Gobo 6
	056 - 063	Gobo 7
	064 - 073	Gobo 1 shake effect
	074 - 082	Gobo 2 shake effect
	083 - 091	Gobo 3 shake effect
	092 - 100	Gobo 4 shake effect
	101 - 109	Gobo 5 shake effect
	110 - 118	Gobo 6 shake effect
	119 - 127	Gobo 7 shake effect
	128 - 189	Clockwise gobos rotation : from slow to fast
	190 - 193	No rotation
194 - 255	Counterclockwise gobos rotation: from fast to slow	

5.3 - 15-channel mode (continuation and end)

12	000 - 007	Prism No function
	008 - 255	Prism
13		Prism rotation
	000 - 127	0 - 360° Indexing
	128 - 189	Clockwise rotation from slow to fast
	190 - 193	No rotation
	194 - 255	Counterclockwise rotation from fast to slow
14		Prism macros
	000 - 007	No function
	008 - 038	Prism macro 1
	039 - 069	Prism macro 2
	070 - 100	Prism macro 3
	101 - 131	Prism macro 4
	132 - 162	Prism macro 5
	163 - 193	Prism macro 6
	194 - 224	Prism macro 7
	225 - 255	Prism macro 8
15		Special functions
	000 - 069	No function
	070 - 079	Black-out during PAN and TILT movements
	080 - 089	No black-out during PAN and TILT movements
	090 - 099	Black-out during colour changes
	100 - 109	No black-out during colour changes
	110 - 119	Black-out during gobo changes
	120 - 129	No black-out during gobo changes
	130 - 199	No function
	200 - 209	Reset all
	210 - 249	No function
	250 - 255	Music-sensitive mode: shows 1 to 4 sequencing

6 - DMX cabling and addressing for each mode

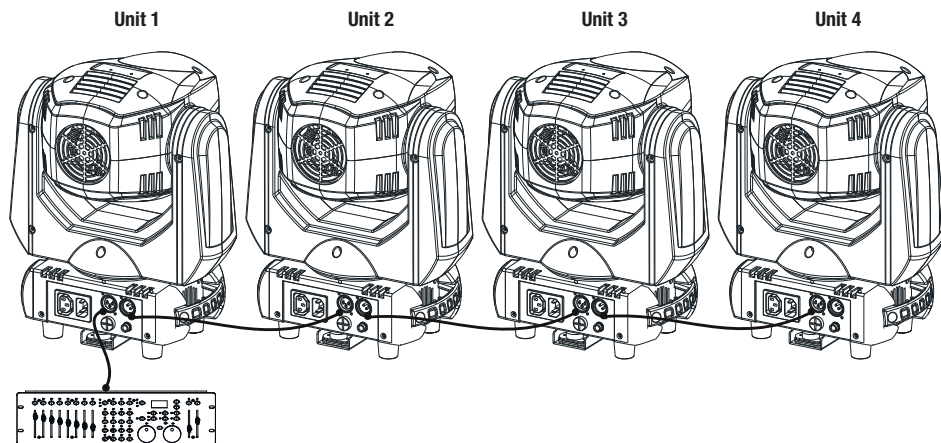

DMX mode	Unit 1 address	Unit 2 address	Unit 3 address	Unit 4 address
1 channel	1	2	3	4
9 channels	1	10	19	28
15 channels	1	16	31	46

7 - How to use the EASY-2 remote control (optional)

The EASY-2 remote control is straightforward and easy to install. It is able to control several synchronised units with the Master/Slave mode.

Plug your remote control into the Master projector Jack 6.35 chassis called «ONLY FOR REMOTE CONTROL», and daisy chain the additional units via the XLR plugs, as you would for a regular DMX cabling. This remote control gives you access to the following functions: black-out, strobe, and show selection.

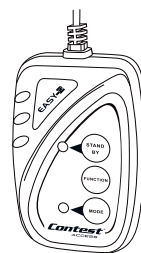

Button	Action		
STAND - BY	Black-out		
FUNCTION	For each pressure and when hold down : 1 : Synchronised strobe 2 : Asynchronous strobe 3 : Music-sensitive strobe	For each pressure: 1 : Show 1 2 : Show 2 3 : Show 3 4 : Show 4	1 : For each pressure: Colour selection 2 : For each pressure and when hold down : Gobos selection
MODE	Music-sensitive mode (LED OFF)	Show (Flashing LED)	Gobos and colours selection (LED allumée)

8 - Gobos and colours

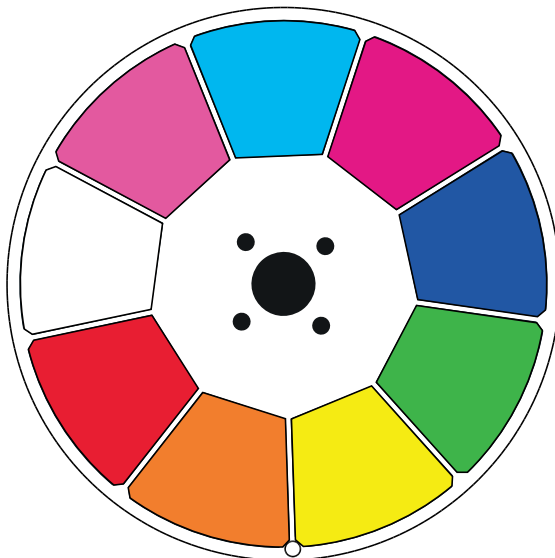
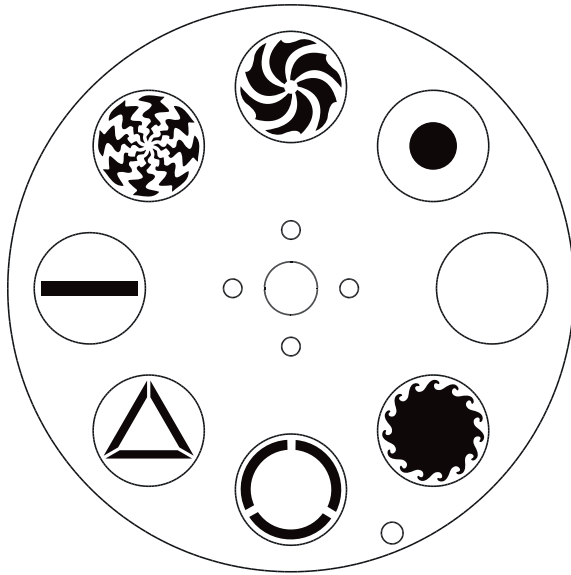

9 - Notes

Because CONTEST® takes the utmost care in its products to make sure you only get the best possible quality, our products are subjects to modifications without prior notice. That is why technical specifications and the products physical configuration might differ from the illustrations.

Make sure you get the latest news and updates about the CONTEST® products on www.contest-lighting.com
CONTEST® is a trademark of HITMUSIC S.A. - Zone Cahors sud - 46230 FONTANES - FRANCE