

4. Operation Panel and Component Instruction:

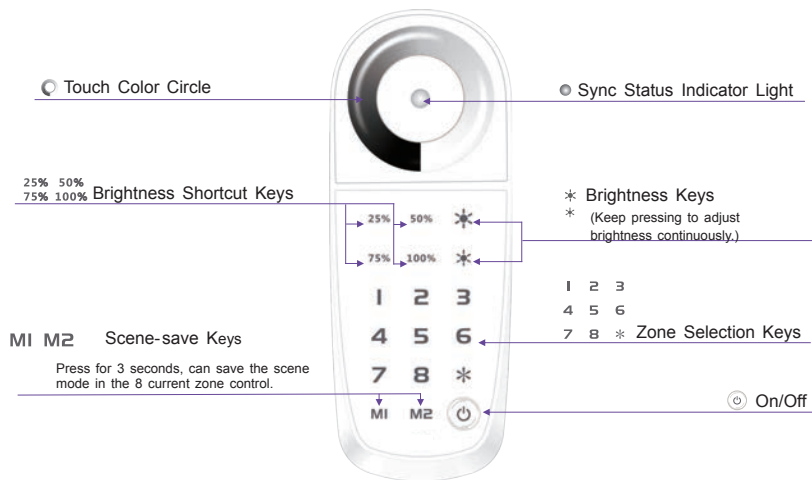

Zone selection keys instruction

Select one of the zone: press keys 1-8 on the remote control.

Select zone control arbitrarily: press " *+any number+* ", eg: take 456 as a zone, should press " *456* ".

All choose(8 zones): press " * " twice.

When a zone is under inactive state, press the "zone selection key" to light up that zone.

Press "ZONE SELECTION KEYS" * in 3 seconds, the buzzer can be on or off.

5. Other Special Functions:

A. Reset Function:

Feature: Reset function is available when remote operates abnormally.

Operation: Long press simultaneously, release the 2 keys after 3 seconds, the remote will auto off, means reset completed. and then could restart the remote.

B. Check and Edit the Frequency Point on the Remote:

Feature:

- a. Revising the frequency point to eliminate the external disturbance. 12 revisable frequency points for user.
- b. Multiple remotes sync-control becomes available when they use the same frequency point.

Attn: After reset or revised the frequency points in the remote, receivers only can be used after relearn the ID.

Check the Frequency Point on the Remote:

Turn on the remote, long press the on/off key for 5 seconds until the white light flashes 3 times, and then the white light flashes, the numbers of the green flash will be the frequency point of the remote. you can only edit the frequency point after 3 seconds.

Edit the Frequency Point on the Remote: In frequency changing state

Method 1: short press any key from 1-8 and * key, the frequency point will be 1-9 correspondingly(*represent 9), the white light will flash in the same numbers. Press again any key or touch the color circle to exit the frequency edit state.

Method 2: long press "on/off" key over 5 seconds, the white light flashes, the flash times plus 1 means the frequency point accumulate 1. In short, long press the "on/off" key 5 seconds each time, the frequency point will accumulate 1, which will again become value 1 when added to 12, and that cycle repeats.

6. System Diagram:

Unlimited receivers can be installed in per zone within the effective distance, no wiring needed between the receivers, the installed number of LED receivers in per zone can be increased or decreased at any time based on the actual requirements. if you want to increase or decrease the receivers, just activate or cancel the control ID on the remote control will be fine, no any changes and effects on other receivers.

After installation, customers have three zone-control choices via remote control :

1. Chose one zone separately: anyone zone in 1-8 zones.
2. Choose combination zone-control arbitrarily: the arbitrary zone-control combination are available in 1-8 zone, such as 246, 678 etc.
3. All choose: choose all 1-8 zone.

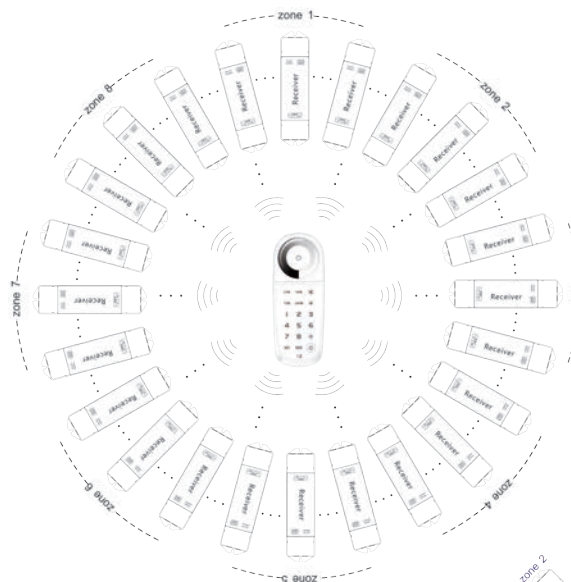

Centralized Zone-division

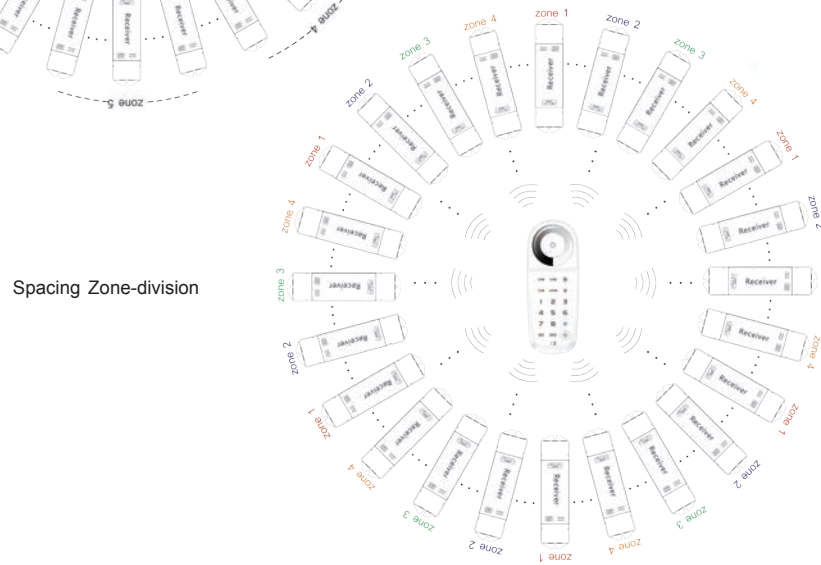

Spacing Zone-division

7. Wiring Diagram:

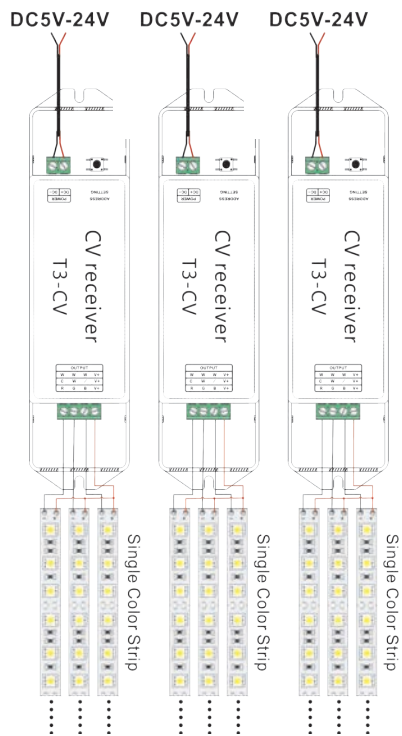

8. The Charging Methods for Remote Control:

1. When charging, please connect USB cable to the mobile charger or computer with the USB interface.
2. The downside white light of 3 in 1 white LED indicator flickers while charging, and the upside white indicator light is on, means the charging is finished. The remote control can be chargeable even at the OFF state, on which the indicator light is black.
3. No memory effect in the lithium battery of remote control. Follow the standard charging procedure, no need for overcharge for the first 3 times .
4. Indicator light flickers(the right side white indicator light is on) meaning low battery and need to be charged. charging in low battery will affect life of battery.
5. The remote should be full charged and stored under low cold drying while a long time without being operated. And please full recharge every 3 months.

9. Attention:

1. The product shall be installed and serviced by a qualified person.
2. This product is non-waterproof. Please avoid the sun and rain. When installed outdoors please ensure it is mounted in a water proof enclosure.
3. Good heat dissipation will prolong the working life of the controller. Please ensure good ventilation.
4. Please check if the output voltage of any LED power supplies used comply with the working voltage of the product.
5. Please ensure that adequate sized cable is used from the controller to the LED lights to carry the current. Please also ensure that the cable is secured tightly in the connector.
6. Ensure all wire connections and polarities are correct before applying power to avoid any damages to the LED lights.
7. If a fault occurs please return the product to your supplier. Do not attempt to fix this product by yourself.

Because CONTEST[®] takes the utmost care in its products to make sure you only get the best possible quality, our products are subjects to modifications without prior notice. That is why technical specifications and the products physical configuration might differ from the illustrations.

Make sure you get the latest news and updates about the CONTEST[®] products on www.contest-lighting.com
CONTEST[®] is a trademark of HITMUSIC S.A. - Zone Cahors sud - 46230 FONTANES - FRANCE

REMOTERF-10RGB and TAPEDRIVER-RF3/TOUCH-RF3 2.4G LED RGB Controller



It is the 2.4GHZ RF wireless synchronization/zone RGB controller which adopts CONTEST multiple global initiate technology. The control system consists of two parts, the RF remote control and receiver, realize the signal synchronization on multiple receivers, zone controlled arbitrarily (no more than 10 zones) within effective distance, a very good solution for the LED project needs sync control wirelessly. User-friendly touch full-color wheel for color selection, unique LED state light for sync change indicated, user can simply know the LED working state from distance by checking the remote control. Can RF remote the functions of switch, pause, changing modes, changing speed and the brightness and so on. Satisfied with your requirement of sync control multiple zones, group control or control separately, which it is easy to use.

1. Technical Specs:

REMOTERF-10RGB Remote Control

- Input Voltage: DC5V Built-in Lithium Battery
- Working Current: <30mA
- Working Frequency: 2.4GHZ
- RF Remote Distance: 30m
- Remote Option: Sync or Zone Control
- Change mode: 18 Fantastic modes
- Battery Capacity: 1000mAh
- Standby Time: 6 months
- Normal Using Time: 30 days
- Dimension: L145×W55×H22(mm)
- Package Size: L168×W102×H28(mm)
- Weight (G.W.): 200g

TAPEDRIVERTOUCH-RF3 Receiving controller

- Input voltage: DC12V-DC24V
- Max current load: 5A×3CH Max 15A
- Max output power: 180W/360W(12V/24V)
- Control button: 8 touch button
- Compatible remote control: workable with REMOTERF-8W and REMOTERF-10RGB
- Working temperature: -30℃~55℃
- Dimension: L211×W40×H30mm
- Package size: L215×W42×H32mm
- Weight (G.W.): 180g

TAPEDRIVER-RF3 Receiving controller

- Input voltage: DC5V-DC24V
- Max current load: 6A×3CH Max 18A
- Max output power: 90W/216W/432W(5V/12V/24V)
- Compatible remote control: REMOTERF-10RGB
- Working temperature: -30℃~55℃
- Dimension: L175×W44×H30(mm)
- Package size: L178×W48×H33mm
- Weight (G.W.): 150g

2. Product Size:

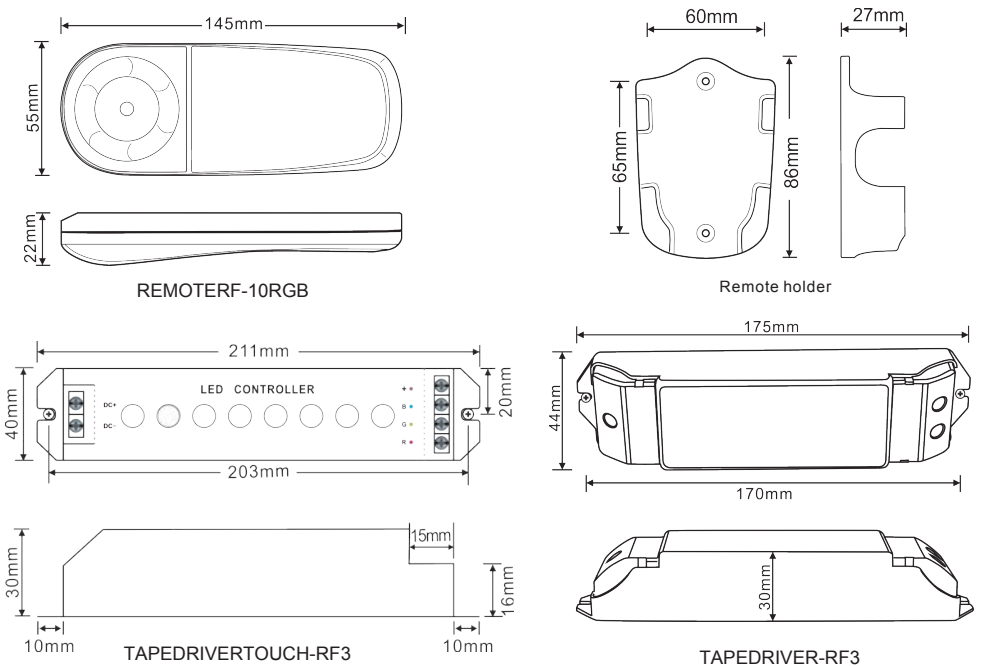

3. The learning ID method of remote control:

T3-5A learning ID:

1. Turn on the receiver and remote control.
2. Press "on/off button" (⏻) on the T3-5A for 2 seconds, there is a buzzer sound, and do not release your hand on the button (⏻), at the same time press any keys of 1-10 zone on the remote control, until the green indicator light (●) of remote control flashes 3 times (a voice prompt at the same time), release all the keys.

T3-5A cancelling ID:

1. Turn on the receiver and remote control.
2. Press "on/off button" (⏻) on the T3-5A for 2 seconds, there is a buzzer sound, and do not release your hand on the button (⏻), after 5 seconds press any keys of 1-10 zone on the remote control, until the red indicator light (●) of remote control flashes 3 times (a voice prompt at the same time), release all the keys.

T3-CC/T3-CV learning ID:

1. Turn on the receiver and remote control.
2. Short press "ID learning button" (🔍) on the receiver, the running light keeps on, then long press any keys of 1-10 zone on the remote, the running light returns to flash (the buzzer long beep, the green light (●) flashes 3 times), activated successful.

T3-CC/T3-CV cancelling ID:

1. Turn on the receiver and remote control.
2. Press "ID learning button" (🔍) on the receiver more than 8 seconds, the buzzer beep twice, delete all the learned remote.

4. Operation Panel and Component Instruction:

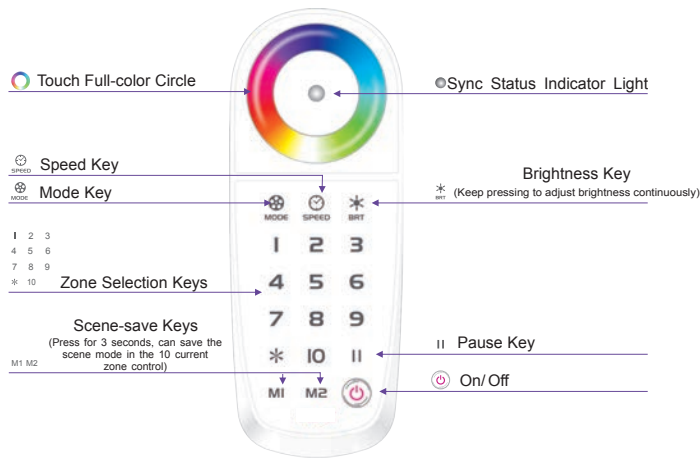

Zoning Instructions:

Select one of the zone: Press keys 1-10 on the remote control.

Select zone control arbitrarily :Press"*+any number+*", eg: take 456 as a zone, should press"*456*"

All choose(10 zones): Press"*" twice.

Press "Pause" button in 3 seconds, the buzzer can be on or off.

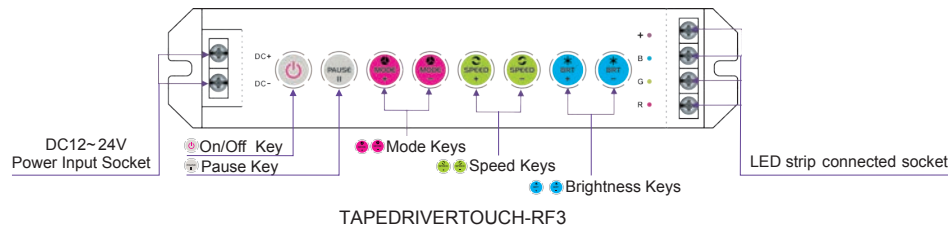

5. Other Special Functions:

A. Reset Function:

Feature: Reset function is available when remote operates abnormally.

Operation: Long press simultaneously, release the 2 keys after 3 seconds, the remote will auto off, means reset completed. and then could restart the remote.

B. Check and Edit the Frequency Point on the Remote:

Feature:

- a. Revising the frequency point to eliminate the external disturbance. 12 revisable frequency points for user.
- b. Multiple remotes sync-control becomes available when they use the same frequency point.

Attn: After reset or revised the frequency points in the remote, receivers only can be used after relearn the ID.

Check the Frequency Point on the Remote:

Turn on the remote, long press the on/off key for 5 seconds until the red light flashes 3 times, and then the green light flashes, the numbers of the green flash will be the frequency point of the remote. you can only edit the frequency point after 3 seconds.

Edit the Frequency Point on the Remote: In frequency changing state

Method 1: short press any key from 1-9, the frequency point will be 1-9 correspondingly, the green light will flash in the same numbers. Press again any key or touch the color circle to exit the frequency edit state.

Method 2: long press "on/off" key over 5 seconds, the green light flashes, the flash times plus 1 means the frequency point accumulate 1. In short, long press the "on/off" key 5 seconds each time, the frequency point will accumulate 1, which will again become value 1 when added to 12, and that cycle repeats.

6. Tables of Changing Mode:

No.	Mode	Description	No.	Mode	Description
1	3 Colors Skipping	Speed/Brightness Adjustable	10	Green Cyan Color Smooth	Speed/Brightness Adjustable
2	7 Colors Skipping	Speed/Brightness Adjustable	11	Blue Purple Color Smooth	Speed/Brightness Adjustable
3	White Strobe	Speed/Brightness Adjustable	12	Green Yellow Color Smooth	Speed/Brightness Adjustable
4	7 Colors Strobe	Speed/Brightness Adjustable	13	Blue Cyan Color Smooth	Speed/Brightness Adjustable
5	Rgb Fade out and Fade in	Speed/Brightness Adjustable	14	Red Purple Color Smooth	Speed/Brightness Adjustable
6	Red Green Color Smooth	Speed/Brightness Adjustable	15	Blue White Color Smooth	Speed/Brightness Adjustable
7	Red Blue Color Smooth	Speed/Brightness Adjustable	16	Yellow Purple Cyan Color Smooth	Speed/Brightness Adjustable
8	Green Blue Color Smooth	Speed/Brightness Adjustable	17	RGB Color Smooth	Speed/Brightness Adjustable
9	Red Yellow Color Smooth	Speed/Brightness Adjustable	18	Full-color Smooth	Speed/Brightness Adjustable

7. System Diagram:

The receivers can be divided into 1~10 zones within effective distance(1pc receiver per zone), no wiring needed between the receivers.

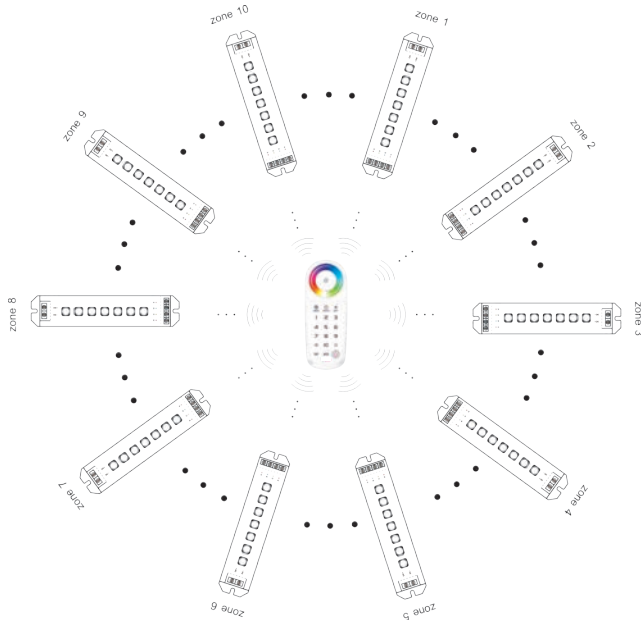

8. Wiring Diagram:

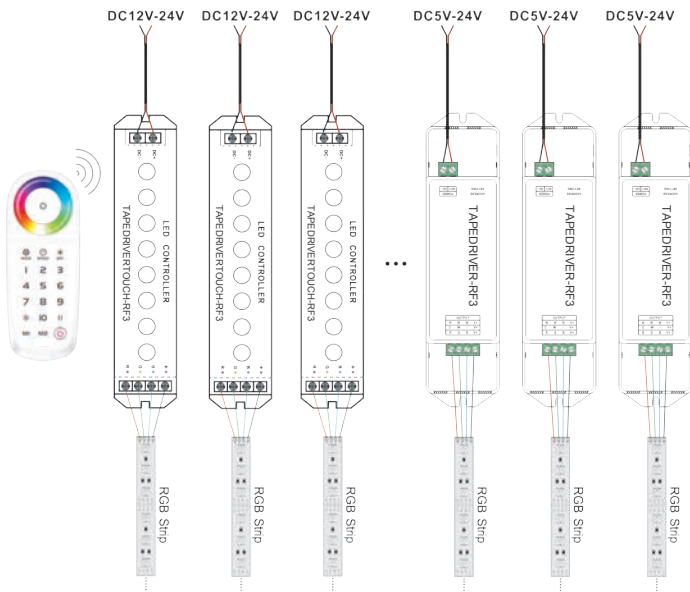

9. The Charging Methods for Remote Control:

1. When charging, please connect USB cable to the mobile charger or computer with the USB interface.
2. The blue indicator light flickers while charging, and turns green means the charging is completed. The remote control can be chargeable even at the OFF state, on which the indicator light is black.
3. No memory effect in the lithium battery of remote control. Follow the standard charging procedure even for the first three times, no need over charge.
4. Red indicator light flickers meaning low battery and need to be charged. charging in low battery will affect life of battery.
5. The remote should be full charged and stored under low cold drying while a long time without being operated. And please full recharge every 3 months.

10. Attention:

1. The product shall be installed and serviced by a qualified person.
2. This product is non-waterproof. Please avoid the sun and rain. When installed outdoors please ensure it is mounted in a water proof enclosure.
3. Good heat dissipation will prolong the working life of the controller. Please ensure good ventilation.
4. Please check if the output voltage of any LED power supplies used comply with the working voltage of the product.
5. Please ensure that adequate sized cable is used from the controller to the LED lights to carry the current. Please also ensure that the cable is secured tightly in the connector.
6. Ensure all wire connections and polarities are correct before applying power to avoid any damages to the LED lights.
7. If a fault occurs please return the product to your supplier. Do not attempt to fix this product by yourself.

Because CONTEST[®] takes the utmost care in its products to make sure you only get the best possible quality, our products are subjects to modifications without prior notice. That is why technical specifications and the products physical configuration might differ from the illustrations.

Make sure you get the latest news and updates about the CONTEST[®] products on www.contest-lighting.com
CONTEST[®] is a trademark of HITMUSIC S.A. - Zone Cahors sud - 46230 FONTANES - FRANCE

REMOTERF-8RGBW and TAPEDRIVER-RF4 2.4G LED RGBW Controller



REMOTERF-8RGBW



TAPEDRIVER-RF4

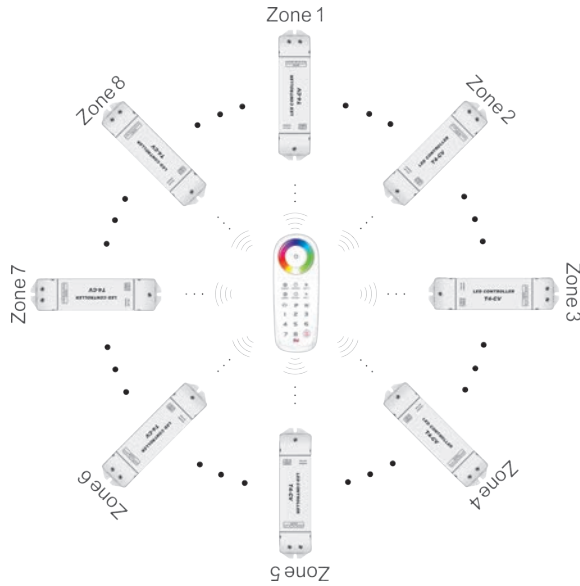

It is the 2.4GHz RF wireless sync/zone RGBW controller which adopts CONTEST4 global initiate technology (2 invention patents, 2 utility patents). It has powerful function that general RF remote control can't realize, especially in wireless connection between receivers to realize sync dynamic change effect. It is very convenient in installation for users. T4 is aggregated all the functions in the favored by customers RGB REMOTERF-10RGB, but simple easy to use.

Performance Features:

1. Adopt 2.4GHz RF wireless transmission technology, which is applicable for license and patent free worldwide.
2. Advanced RF wireless sync control technology, no sync signal wire between receivers, sync capability is stable and reliable.
3. Remote adopts the capacitive touch control technology on the full color wheel, make the LED color selection more user-friendly.
4. With the latest DIY program method, editing effects is easier and more intuitive.
5. Built-in sync state light, can display the LED color in static or changing state synchronously.
6. Sync and zone switch freely.
7. Unmanned operation more than 1 min on the remote, the remote will automatically shut down to realize zero loss, extending operation life for the battery.
8. USB charging port.

1. Technical Specs:

REMOTERF-8RGBW

- Input Voltage: DC5V Built-in Lithium Battery
- Working Current: <30mA
- Working Frequency: 2.4GHZ
- RF Remote Distance: 30m
- Remote Option: Sync/Zone Control
- Grey Scale Level: 4096×4096×4096×4096
- Battery Capacity: 1000mAh
- Dimensions: L145×W55×H22(mm)
- Package Size: L168×W96×H34(mm)
- Weight (G.W.): 210g

TAPEDRIVER-RF4

- Input Voltage: DC5V~DC24V
- Max Current Load: 5A × 4CH Max 20A
- Max Output Power: 100W/240W/480W(5V/12V/24V)
- Working Temperature: -30°C ~55°C
- Package Size: L178×W48×H33(mm)
- Weight (G.W.): 150g

2. The Charging Methods for Remote Control:

1. When charging, please connect USB cable to the mobile charger or computer.
2. The blue indicator light flickers while charging, and turns green means the charging is completed. The remote can be chargeable even at off state, which the indicator light is dark.
3. No memory effect in the lithium battery of remote. Follow the standard charging procedure even for the first three times, no need over charge.
4. Red indicator light flickers meaning low battery and need to be charged. charging in low battery will affect life of battery.
5. the remote should be full charged and stored under low cold drying while a long time without being operated. And please full recharge every 3 months.

3. Product Size:

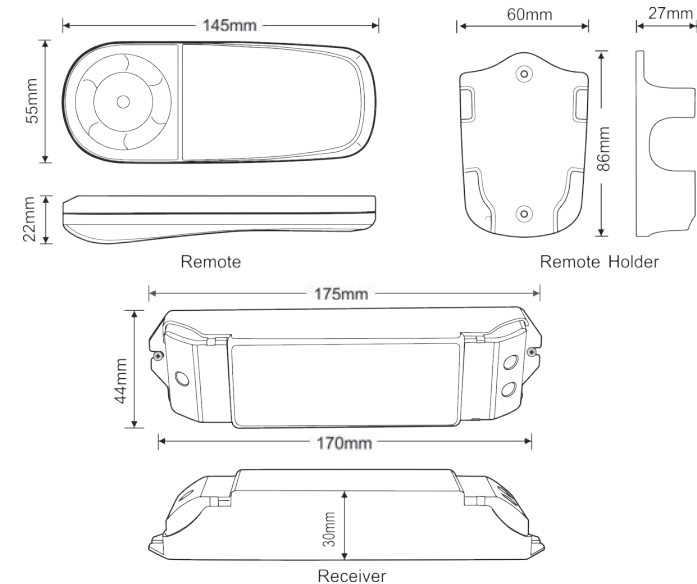

4. Receiver Components Description:



5. The Learning ID Method of Remote:

Learning ID:

1. Turn on the receiver and remote.
2. Short press "ID learning button" on the receiver, the running light keeps on, then long press 1-8 zone-selection keys on the remote, the running light returns to flash (the buzzer long beep, the green light flashes 3 times), activated successful.

Cancelling ID:

Press "ID learning button" on the receiver more than 8 seconds, the buzzer beep twice, delete all the learned remote.

* sync control: 1 remote to unlimited receivers. zone control: 1 remote to Max 8 receivers (1 receiver per zone).

6. Remote Control Instructions:

Built-in two control programs, it is convenient for user's different habits and place, free switching the two programs.

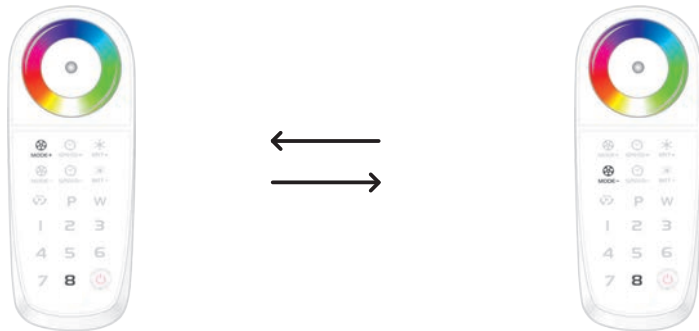

Sync control : Press the key **MODE** and **8** over 2 seconds.

Highlights: control unlimited receivers synchronously; programmable function; 8 save keys.

Zone control : Press the key **MODE** and **8** over 2 seconds.

Highlights: zone control arbitrarily; sync control; programmable function.

* **Power Saving**: unmanned operation more than 1 min on the remote, the remote will automatically shut down to realize zero loss, extending operation life. Press ON/OFF again, it will restart the remote.

Mode keys **MODE+** **MODE-** : Switch black/red/green/blue/yellow/purple/cyan/white/RGB/RGBYPCW

Open the buzzer: long press **MODE+** **Close the buzzer**: long press **MODE-**

A. Sync Program:

The Usage of The Programming "P" :

- 1) Long press the key **P** in 2 seconds, buzzer sounds, enter the programming mode.
- 2) Color selection : Saved 8 colors in NO. 1-8, press NO.

1	2	3
4	5	6
7	8	

 in order and press **MODE** or color circle

again to select the color.

(color will be saved in this key automatically).

Example1:

1	2	3	4	5	6	7	8
Red	Green	Blue	Yellow	Purple	Cyan	White	Black

R G B Y P C W 7 Colors' Skipping/Smooth/Strobe

Example2:

1	2	3	4	5	6	7	8
Red	Blue	Black	Black	Black	Black	Black	Black

R B 2 Colors' Skipping/Smooth/Strobe

Example3:

1	2	3	4	5	6	7	8
Red	Black	Green	Black	Blue	Black	Black	Black

R BK G BK B 5 Colors' Skipping/Smooth/Strobe

Example4:

1	2	3	4	5	6	7	8
Black	Red	Black	Green	Black	Blue	Black	Black

R G B 3 Colors' Fade out and fade in **BK R BK G BK B** 6 Colors' Skipping/Strobe

Note: Select Black color with keys **MODE+** **MODE-**

- 3) Short press "P" key **P** to exit color selection.
- 4) press **MODE+** to switch the selected colors' skipping, smooth and strobe (Brightness/Speed adjustment).
- 5) Long press any key in 1-8

1	2	3
4	5	6
7	8	

 to save the edit ed scene.

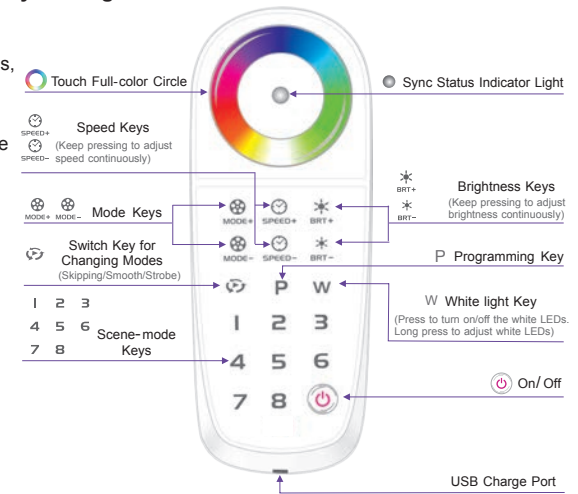

B. Zone Program:

The Usage of The Programming "P" :

- 1) Long press the key **P** in 2 seconds, buzzer sounds, enter the programming mode.
- 2) Color selection : Saved 8 colors in NO. 1-8, press NO.

1	2	3
4	5	6
7	8	

 in order and press **MODE** or color circle

again to select the color.

(color will be saved in this key automatically).

Example1:

1	2	3	4	5	6	7	8
Red	Green	Blue	Yellow	Purple	Cyan	White	Black

R G B Y P C W 7 Colors' Skipping/Smooth/Strobe

Example2:

1	2	3	4	5	6	7	8
Red	Blue	Black	Black	Black	Black	Black	Black

R B 2 Colors' Skipping/Smooth/Strobe

Example3:

1	2	3	4	5	6	7	8
Red	Black	Green	Black	Blue	Black	Black	Black

R BK G BK B 5 Colors' Skipping/Smooth/Strobe

Example4:

1	2	3	4	5	6	7	8
Black	Red	Black	Green	Black	Blue	Black	Black



R G B 3 Colors' Fade out and fade in **BK R BK G BK B** 6 Colors' Skipping/Strobe

Note: Select Black color with keys **MODE+** **MODE-**

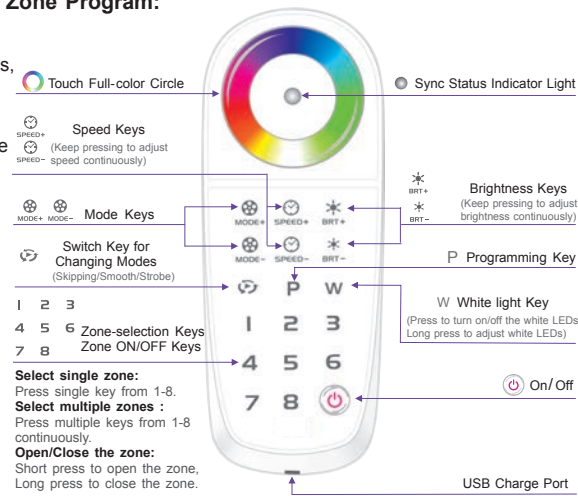
- 3) Short press "P" key **P** to exit color selection.
- 4) Press **MODE+** to switch the selected colors' skipping, smooth and strobe (Brightness/Speed adjustment).
- 5) OK, completed scene editing, short press "P" to play the scene.



7. Tables of Changing Mode:

No.	Color (Press   Button to Switch)	Press  button to switch the 3 types		
		Skipping	Smooth	Strobe
1	Black			
2	Red	Static Red	Red Fade out and Fade in	Red Strobe
3	Green	Static Green	Green Fade out and Fade in	Green Strobe
4	Blue	Static Blue	Blue Fade out and Fade in	Blue Strobe
5	Yellow	Static Yellow	Yellow Fade out and Fade in	Yellow Strobe
6	Purple	Static Purple	Purple Fade out and Fade in	Purple Strobe
7	Cyan	Static Cyan	Cyan Fade out and Fade in	Cyan Strobe
8	White	Static White	White Fade out and Fade in	White Strobe
9	Red, Green, Blue	RGB Skipping	RGB Color Smooth	RGB Strobe
10	Red, Green, Blue, Yellow, Purple, Cyan, White	7 Colors Skipping	Full-color Smooth	7 Colors Strobe

8. Wiring Diagram:

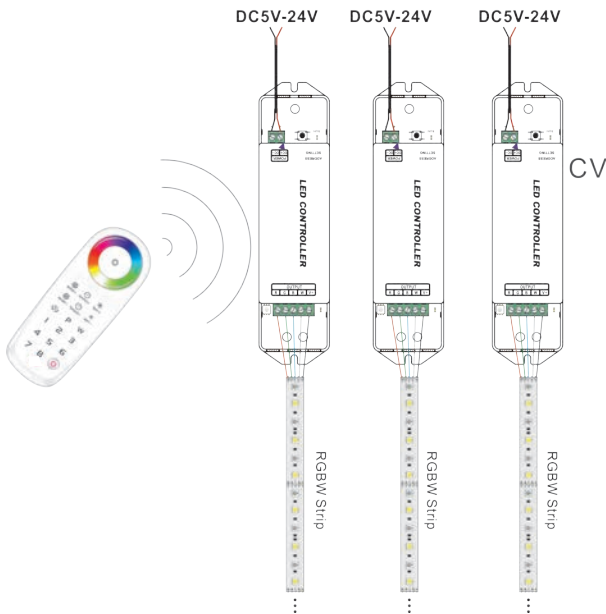

9. Other Special Functions:

A. Reset Function:

Feature: Reset function is available when remote operates abnormally.

Operation: Long press  simultaneously, release the 2 keys after 3 seconds, the remote will auto off, undo for more than 1 min. means reset completed. and then could restart the remote.



B. Check and Edit the Frequency Point on the Remote:

Feature:

- a. Revising the frequency point to eliminate the external disturbance. 12 revisable frequency points for user.
- b. Multiple remotes sync-control becomes available when they use the same frequency point.



Attn: After reset or revised the frequency points in the remote, receivers only can be used after relearn the ID.

Check the Frequency Point on the Remote:

Turn on the remote, long press the on/off key  for 5 seconds until the red light  flashes 3 times, and then the green light  flashes, the numbers of the green flash will be the frequency point of the remote. you can only edit the frequency point after 3 seconds.

Edit the Frequency Point on the Remote: In frequency changing state

Method 1: short press any key from 1-8, the frequency point will be 1-8 correspondingly, the green light will flash in the same numbers. Press again any key or touch the color circle to exit the frequency edit state.

Method 2: long press "on/off" key  over 5 seconds, the green light  flashes, the flash times plus 1 means the frequency point accumulate 1. In short, long press the "on/off" key  5 seconds each time, the frequency point will accumulate 1, which will again become value 1 when added to 12, and that cycle repeats.

10. Attention:

1. The product shall be installed and serviced by the qualified person.
2. This product is non-waterproof. Please avoid the sun and rain. When installed outdoors please ensure it is mounted in a water proof enclosure.
3. Good heat dissipation will prolong the working life of the controller. Please ensure good ventilation.
4. Please check if the output voltage of the LED power supply used comply with the working voltage of the product.
5. Please ensure that adequate sized cable is used from the controller to the LED lights to carry the current. Please also ensure that the cable is secured tightly in the connector.
6. Ensure all wire connections and polarities are correct before applying power to avoid any damages to the LED lights.
7. If a fault occurs please return the product to your supplier. Do not attempt to fix this product by yourself.

Because CONTEST[®] takes the utmost care in its products to make sure you only get the best possible quality, our products are subjects to modifications without prior notice. That is why technical specifications and the products physical configuration might differ from the illustrations.

Make sure you get the latest news and updates about the CONTEST[®] products on www.contest-lighting.com
CONTEST[®] is a trademark of HITMUSIC S.A. - Zone Cahors sud - 46230 FONTANES - FRANCE