

1 - Output type selection and connections

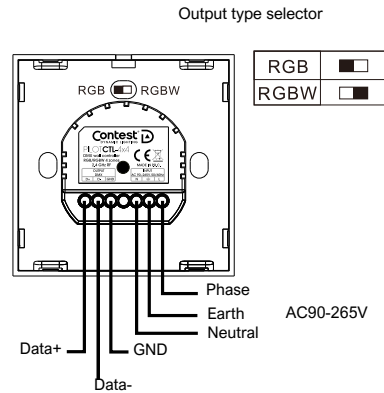

Tip: When the panel is to emit DMX512 signals, the output type must be defined according to the products to be controlled.

2 - Installation

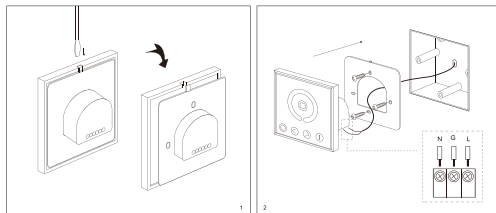

3 - The keys and their functions

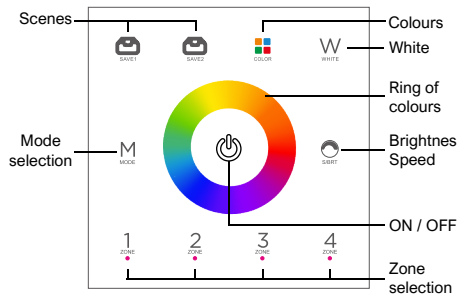

Key	Action
ON/OFF	Switches the output on and off.
SAVE 1 - 2	Press once briefly to recall the previously stored lighting status. Factory setting : SAVE1=Step of 7 colours, SAVE2=Fade of 7 colours. Storing a scene (SAVE1 button, for example) : 1) Press the SAVE1 button three times quickly (within 3 seconds) to enter the scene 1 setting state. 2) Set the light scene using the zone and the light control button. 3) After setting, press the SAVE1 button again to save, or press other SAVE buttons to exit. Note: The configuration process should be completed in less than a minute and will be automatically interrupted if this period expires.
Color	Red, Green, Blue, Yellow, Violet, Cyan successively.
W	When the receiver is in RGB mode, it's a shortcut to white. When the receiver is in RGBW mode, it activates the white of the ribbon.
Ring of colour	Used to navigate through the RGB colours.
S/BRT	Static brightness adjustment (short press with 5 brightness levels 10%, 25%, 50%, 75%, 100%); speed adjustment for dynamic modes, can be quickly adjusted with a long press. Note: the brightness up/down button is a common brightness button for RGB and White. In the static RGB setting, it is used to adjust the RGB brightness. In W mode, it is used to adjust W brightness. You can switch from RGB to W by pressing the "white light button" and from W to RGB by pressing the "ON/OFF" button.
M	8 dynamic modes
Zones 1 - 4	1) 4 zone selection buttons, and the corresponding LED lights up when the zone is selected. 2) You can freely select 1 group / 2 groups / 3 groups / 4 groups for simultaneous control. 3) Press any zone button for 2 seconds and the four LEDs will light up. lights come on simultaneously, allowing you to switch to full control.

Brightness cannot be adjusted when dynamic mode is in use. Dynamic mode retains the brightness of static mode.

The 8 dynamic modes				
N°	Pattern	N°	Pattern	Note
1	Chain of white	5	7 fade colours	Speed is adjustable. The light intensity is not adjustable.
2	3 colours in step	6	Fade Red/Green	
3	7 colours in step	7	Fade Red/Blue	
4	3 fade colours	8	Fade green/blue	

4 - Communication methods

Type of communication	Technology	Environment
Wireless	RF 2.4GHz	Installations where the project environment does not lend itself to cabling. The distance between the devices is in the effective range of wireless signals.
Wired	DMX512 signal	Allows greater distances between devices.

5 - DMX addressing

Zone	RGB Mode			RGBW mode			
	R	G	B	R	G	B	W
Zone 1	1	2	3	1	2	3	4
Zone 2	4	5	6	5	6	7	8
Zone 3	7	8	9	9	10	11	12
Zone 4	10	11	12	13	14	15	16

5 - The different control methods

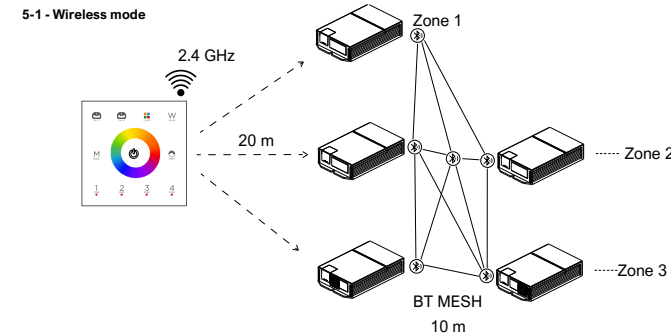

5-2 - Wired mode

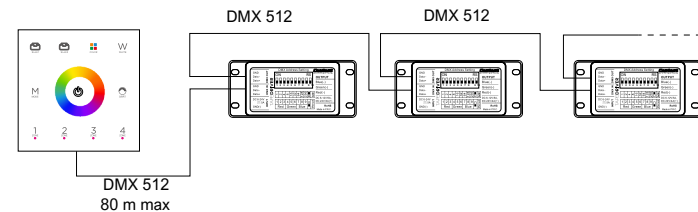

5-3 - mixed mode (wired and wireless)

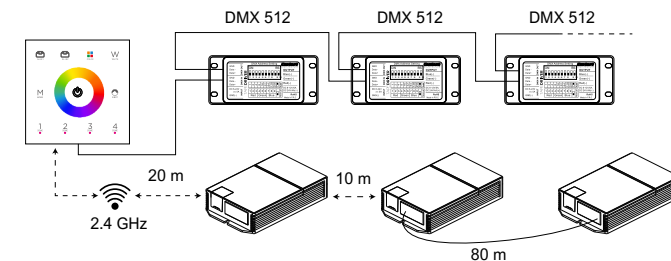

7 - Setting up the wall controller

To facilitate initial testing and debugging of the project, the receiver is normally mismatched at the factory and each panel has a unique code value.

The user must match the panel and receiver when installing the project to avoid radio frequency interference.

After installation, all the equipment in the complete system must have a single, unified code value, to ensure system stability.

Before learning the new code, it is necessary to erase the receiver's original code; the remote control can only store one code, but it can be reset and can also restore the factory settings.

To facilitate subsequent maintenance, the three components that may be involved in the system (receivers, hand-held remote controls and control panels) can be synchronised to a single code.

As the receiver retrieves the code value when it is switched on, it is possible to proceed in batches (switch on all the receivers in the same zone, and the RF code will be paired on all the receivers at the same time).

To avoid any confusion within the zone, it is recommended that each zone has its own independent power supply.

7-1 - Pairing: Transmitting the code to the receiver

Stage	Action	Instruction
1	Switch on the receiver	1 - If the receiver has already been coded, the code must first be deleted.
2	Select the zone	Use the Zone button and the corresponding indicator will light up.
3	Press and hold the " SAVE 1 " button on the control panel for 5 seconds. The LED indicating the selected zone will flash rapidly, indicating that it is entering the pairing code transmission phase.	The control panel automatically exits transmission mode after 60 seconds or after any key is pressed.
4	The ribbon connected to the receiver flashes 3 times and returns to its initial state.	The pairing procedure is complete.

7-2 - Disassociation: Clearing the receiver code

Stage	Action	Instruction
1	Switch on the receiver	1 - The erasing operation must be completed within one minute of the receiver being powered up. If this time limit is exceeded, the receiver can be powered up again to restart the operation. 2 - Several code deletions can be made within the range of the remote control.
2	Press and hold the " SAVE 2 " button on the control panel for 5 seconds. The panel's indicator LED flashes rapidly, meaning that it switches to code transmission mode. To delete. It is not necessary to select the corresponding zone when deleting the code.	1 - The control panel automatically exits transmission mode after 60 seconds or after any key is pressed. 2 - If the original control panel is lost, a new control panel can be used for erasing operations.
3	The ribbon connected to the receiver flashes 3 times and returns to its initial state.	The code deletion procedure is complete.

7-3 - Spreading a code across several control panels

As each control panel has its own code at the time of delivery, when there are several control panels in a system, one of them (for example, panel A) must be selected as the central code value for the system, and the code of the other control panels (for example, panel B) must be copied to the same code value.

Stage	Action	Instruction
1	On panel A, press and hold the " SAVE 1 " button for 5 seconds; the panel's zone LED flashes rapidly, indicating that it is entering the pairing code transmission phase.	The panel exits transmission mode automatically after 60 seconds or after pressing any key.
2	On panel B, press and hold the " ON/OFF " button for 5 seconds. The zone LED(s) on the panel will go out, indicating that the code is being received.	The panel exits receive mode automatically after 30 seconds or when the code has been received.
3	One of the zone LEDs on panel B flashes 3 times.	The code copy is complete.

7-4 - Copying a code from a receiver

A new panel can also copy the code of any receiver in the whole system. After a successful operation, the new panel can replace the original panel.

Stage	Action	Instruction
1	Switch off the receiver.	The one that will be controlled by the panel.
2	On the panel, press and hold the " ON/OFF " key for 5 seconds. The zone LED(s) on the panel will go out, indicating that the code is being received.	The panel exits receive mode automatically after 30 seconds or when the code has been received.
3	Switch on the receiver, the LED in the relevant zone will flash 3 times	The code copy is complete.

- For the safety of the system, the distance between the panel and the receiver must be less than 2 metres.

7-5 - Restoring the original factory code

Stage	Action	Instruction
1	Press and hold the " ON/OFF " button for 20 seconds	The zone LED on the panel goes out at 5 ^{min} seconds, then comes back on after 20 seconds. This means that this stage is complete.
2	Press the " SAVE 2 " button, the LED in one of the panel zones will flash 3 times.	Factory settings have been restored successfully.

8 - Key features

Electrical characteristics	
Input voltage	AC 90-265V
RF frequency	2.4 GHz
RF distance	< 20 m
Wired control	DMX 512
Consumption	< 0.58 W / <1.1 W
Field of application	RGB / RGBW
Special features	
PWM frequencies available	2KHz /15KHz
Output dimming	1024 levels
Speeds	1024 levels
RF connection distance	Up to 20m
Protection	Short circuits
Operating environment	
Ambient temperature	From 0°C to +45°C
IP index	20
Physical characteristics	
Dimensions	86 x 86 x 32
Weight	120 g
Colour	White / Black

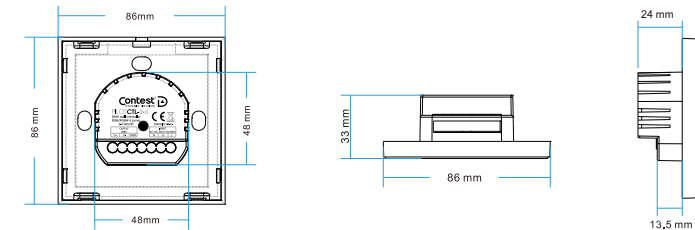

The CONTEST® brand takes the greatest care in the manufacture of its products to guarantee the highest quality. Changes may therefore be made without prior notice. For this reason, the technical characteristics and physical configuration of the products may differ from the specifications and illustrations presented in this manual. For the latest product information and updates visit <https://dyna.lighting/> CONTEST® is a trademark of HITMUSIC S.A.S - 595 rue de la Pièce Grande - 46230 FONTANES - FRANCE www.hitmusic.eu