



[www.yes-led.com](http://www.yes-led.com)



Facebook

## MG14 Series LED Screen User Manual

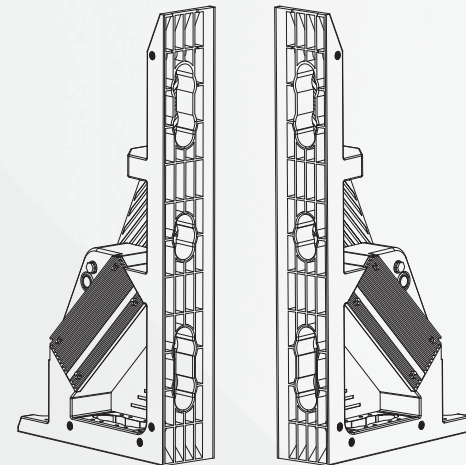

HQ address: YES TECH Optoelectric Industrial Park, No.108 Qingzhu Road,  
Kaifu District, Changsha City, Hunan Province, China

Tel: +86-731-84539619/84530058

Web: [www.yes-led.com](http://www.yes-led.com)

E-mail: [yestech@yes-led.com](mailto:yestech@yes-led.com)

The first edition in 2019

# CONTENTS

<b>CAUTION</b> .....	01
<b>PREFACE</b> .....	04
<b>Chapter 1</b> LED Cabinet .....	05
1.1 Cabinet Structure .....	05
<b>Chapter 2</b> Cabinet Connection .....	07
2.1 Connectors and Cabinet Mounting Socket Connection .....	07
2.2 Signal and Power Cable Connection .....	09
<b>Chapter 3</b> LED Screen Installation & Packing .....	10
3.1 MG14 Series LED Screen Installation .....	11
3.2 MG14 Series LED Screen Packing .....	22
<b>Chapter 4</b> Frequently Questions For LED Screen .....	24
4.1 Software Questions .....	24
4.2 Hardware Questions .....	25
<b>Chapter 5</b> LED Screen Maintenance .....	26
<b>Chapter 6</b> Product Parameter & Specification .....	29

## CAUTION



### Caution 1:

In order to avoid any physical damage, please read the User Manual carefully before connecting the switches.

1. LED screen should only be operated by trained professionals.
2. Do not expose any part of the LED screen to naked flame/smoke.
3. Personnel operating the LED screen are advised to wear a safety helmet during operation.
4. Check all the AC power is connected before turning on the switch.
5. Turn off all switches of the LED screen, computer terminals, system box and monitors before performing any maintenance work.
6. Do not touch the power supply when the switch is turned on.

### Caution 2:

Please read the installation and operation instruction manual carefully in order to make sure the normal lifespan of LED screen and avoid any damage of electronic components, device driver and lose of data.

1. Turn off all switches including LED screen, computer terminal, system box and monitor before connecting any cables.
2. Wear Anti-static ring before replacing any electronic components.
3. Do not hot plug any cables connected to computer terminals while the power is running. Ensure that all power is disconnected before unplugging any cable from the ports especially the serial line ports.
4. Avoid the cabinet work under the conditions of high organic solvent detergent (such as kerosene, rust-proof oil, etc).
5. Regular electricity testing is required for indoor LED screen if long time no use. (regular electricity testing standard: at least 2 hours in a week increase gray scale stepwise)
6. The operating/storage environment should conform to the requirements in product parameter&specification sheet, otherwise it will damage the LED screen seriously.
7. In order to ensure the safety, please check the condition of power cables every three months if rental usage, every year if fixing installation.

### Caution3:

1. Making sure the LED screen should be properly grounded before working.
2. LED screen grounding resistance must be less than  $1\Omega$ .
3. If the LED screen is equipped with flight cases, the flight cases should not be exposed to rain. After each performance is completed, please pay attention to the moisture-proof treatment of the flight cases.

Caution 4:

1. The LED screen should not be installed in a humid environment. The LED screen lamp surface should not be touched directly without static protection.
2. The LED screen should be equipped with air conditioning in the absence of air conditioning indoors or indoor environment temperature above 30°C.

Special statement:

Our company does not compensate for the personal injury or material loss caused by the users' arbitrarily transforming or repairing this product. Please contact our company beforehand when it is needed to repair or remould the product.

Warranty period:

- In principle, the product warranty period is based on the product warranty period specified on the quotation.
- During the warranty period, our company will not guarantee any problems due to the following reasons.
  - Problems caused by the user's arbitrarily dismantling the product or failing to perform maintenance properly.
  - Problems caused by incorrect transport and storage.
  - Problems caused by the use of exceeding the rated parameters of the product.
  - Problems caused by improper installation.
  - Problems caused by fires, earthquakes, storms, floods, lightning and other natural disasters or riots, wars, radioactivity, etc. and other natural and man-made disasters.

## PREFACE

Magic MG14 series used as MG series accessory products. The product distinguishes between 14A cabinet and 14B cabinet, which are symmetric mirror structures. It currently contains YMG14A-M04NFD, YMG14A-M04UFQ, YMG14B-M04NFD, and YMG14B-M04UFQ. By connecting with other MG series products, the MG14 series can realize creative installation such as circular installation, which can meet more market demands and broaden more application, our screen has become an important choice for stage show/rent, exhibitions, shows and commercial advertising.

To ensure that our products are used within reasonable conditions and get your recognition, we will explain installation process, using process and cautions in details. Please read this carefully before installing and testing screen. If there is no special instruction, the operation method on the manual can apply to all the models of these series products.

## Chapter 1 LED Cabinet

The LED cabinet mainly includes power supply, modules, and receiving card.

### 1.1 Cabinet Structure

The cabinet structure of MG14 series cabinet is made of high polymer nanomaterial. It is lighter than traditional aluminum alloy die-castings cabinet. The cabinet size is 250mm\*500mm\*73mm. (Figure 1.1.1), divide into MG14A Cabinet and MG14B Cabinet.

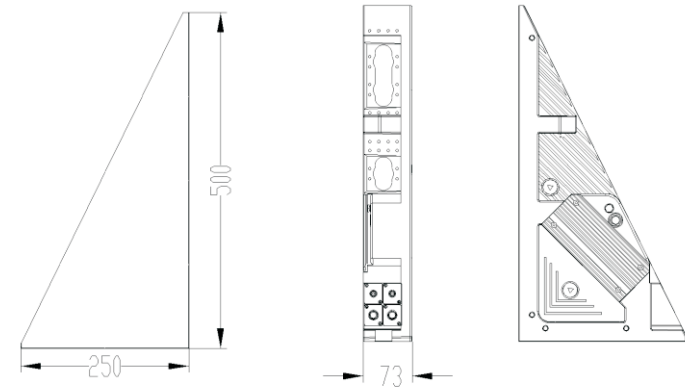

MG14A

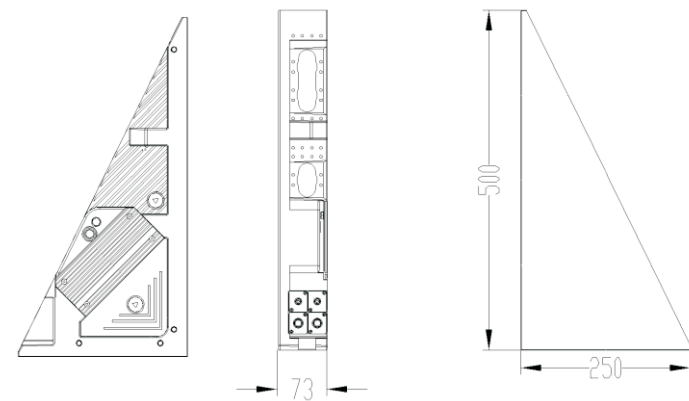

MG14B

Figure 1.1.1 Cabinet view from all sides

## Chapter 2 Cabinet Connection

### 2.1 Connectors and Cabinet Mounting Socket Connection

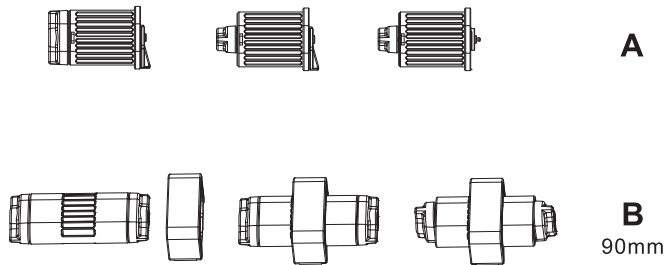

Figure 2.1.1 Connectors for cabinet

As shown in Figure 2.1.1. A&B is the connector of the cabinet. Connectors are mainly used for connecting and fixing between cabinets.

The maximum vertical bearing capacity of Connector-A is 7000 N, the safety bearing capacity is 1200 N. It can be used more than 2000 times, and stored more than 3 years;

The maximum horizontal bearing capacity of Connector-B is 1500 N, the safety bearing capacity is 500 N. It can be used more than 2000 times, and stored more than 3 years;

As shown in Figure 2.1.2, there are 3 mounting sockets on the side of 500mm and 1 mounting sockets on the side of 250mm. 3 mounting sockets on left and right side of the frame, where the connectors can be inserted. Tightly twist the end of the connectors to lock the cabinets in place. One by one, the cabinets can be connected easily and fast with “one slot and one twist”.

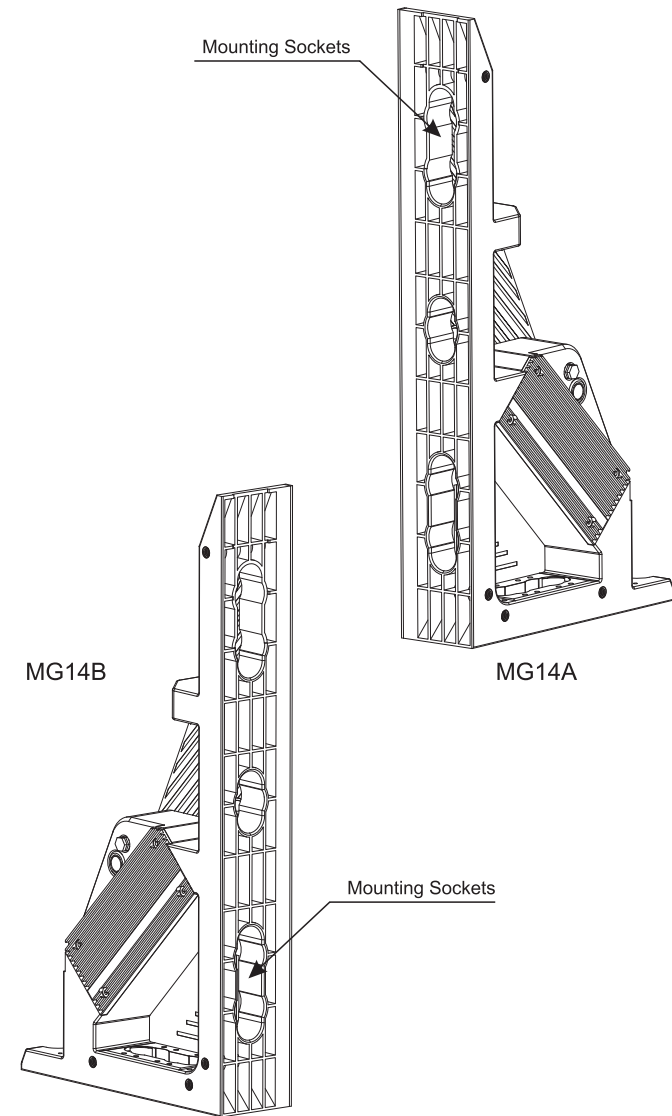

Figure 2.1.2 Mounting Sockets of the cabinet

## Chapter 3 LED Screen Installation and package

### 2.2 Signal and Power Cable Connection between Cabinets

Adopting Cat5 cable (signal cable) (Figure 2.2.1) and power cable (Figure 2.2.2) to connect each cabinet.

MG14 standard cabinet using four cables fixing on the cabinet, two signal cables and two power cables. Cabinet to cabinet signal connection needs to use signal connector, and the power supply can be connected to each other directly.

One cabinet be connected by 2 signal cables, one port input and one port output, the input signal of the cabinet comes from the last cabinet output signal, the output signal of the cabinet connect next cabinet input signal, this connection way is as same as power cable.

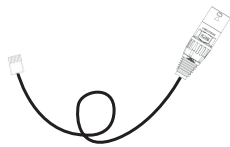

Figure 2.2.1 Cat5 cable (signal cable)

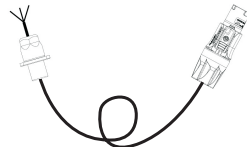

Figure 2.2.2 Power cable

The signal line source is sending card end, including the PC with the sending card, control box, the video processor with sending card.

In order to achieve various shapes, the MG14 cabinet is designed with different mounting holes, which can be realized by dislocation installation with other MG series products. You need to pay attention to the following two points before installation.

Note 1:

All installation methods are required to avoid collision of the frontage 3 corners of the cabinet (Figure 3.1), causing unnecessary damage and affecting the normal use of the cabinet.

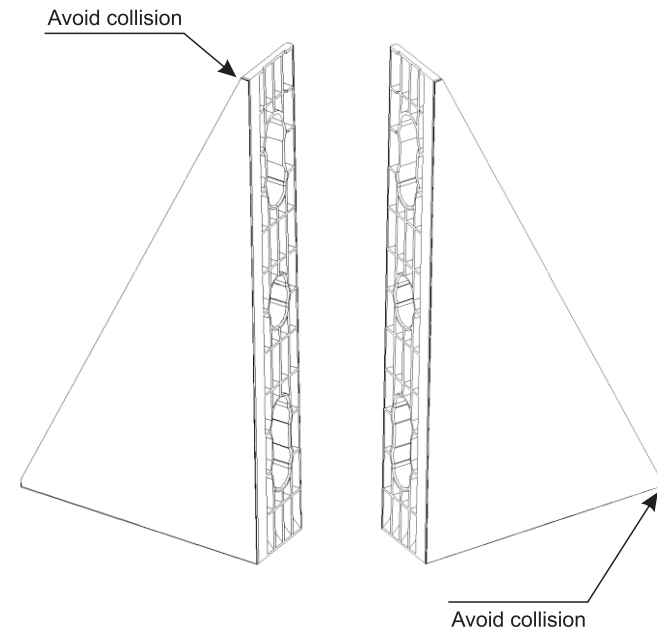

Figure3.1 Cabinet front

Note 2:

When using all types of connectors, in order to ensure the maximum strength connection effect, the locking head needs to be screwed into right place, that is, the locking head and the connector itself are in a vertical state.

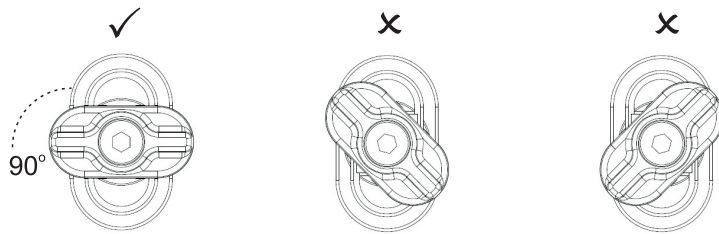
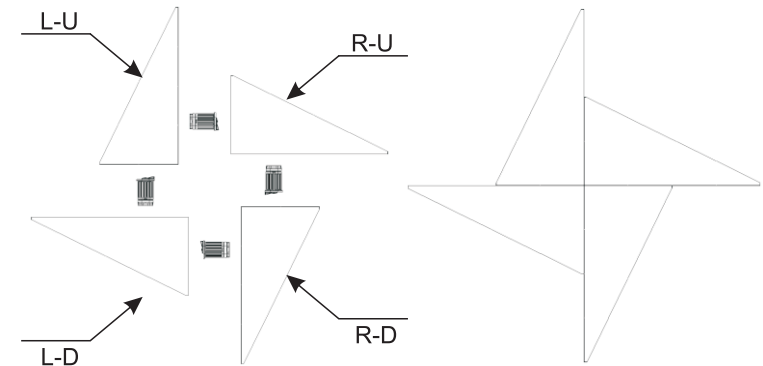

Figure 3.2 The using caution of the locking head of connector

### 3.1 MG14 Series LED Screen Installation

MG14 has 4 models, by rotating the LEDs, it will solve the view angle issue of different direction. The 4 models are R-U, R-D, L-U, L-D. As Figure 3.1.1.



MG14A

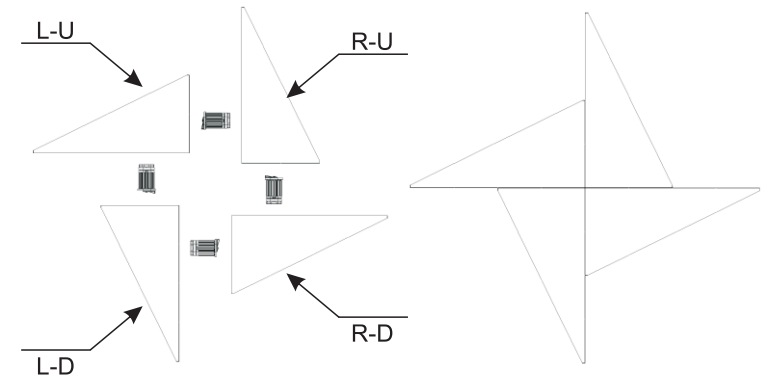

MG14B

Figure 3.1.1 The definition of 4 models



When the MG14 cabinet connects with MG6/MG7/MG12/MG13/MG15 cabinets, should use MG vertical connector (Connector-A), as Figure 3.1.2~3.1.7. When MG14 cabinet connects with MG6/MG7 horizontally, should use 90mm horizontal connector (Connector-B 90mm), as Figure3.1.3.

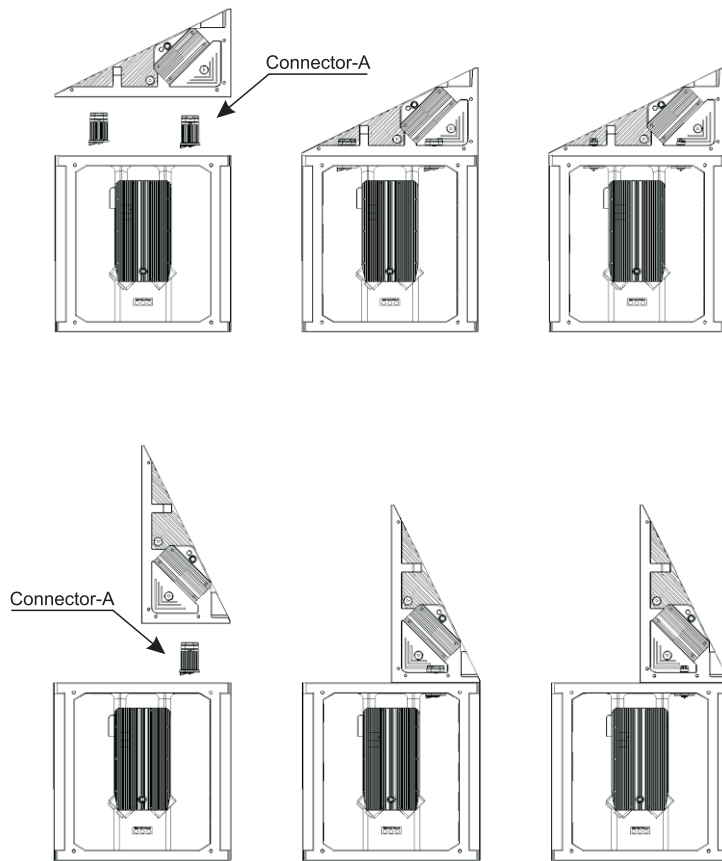

Figure 3.1.2 MG14 connected with MG7 (or MG6) cabinet

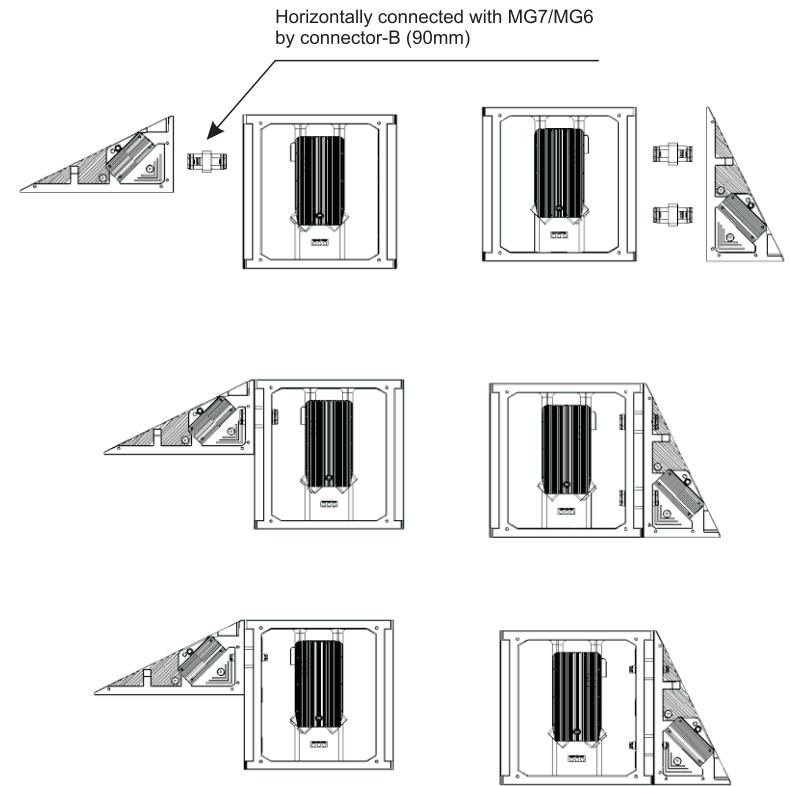

Figure 3.1.3 MG14 connected with MG7 (MG6) cabinet

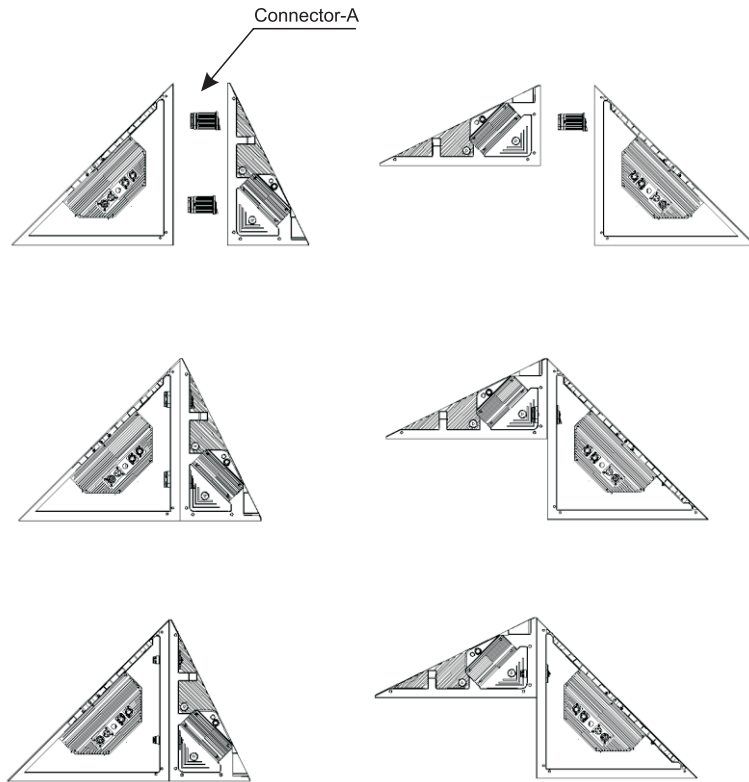

Figure 3.1.4 MG14 connected with MG12 cabinet

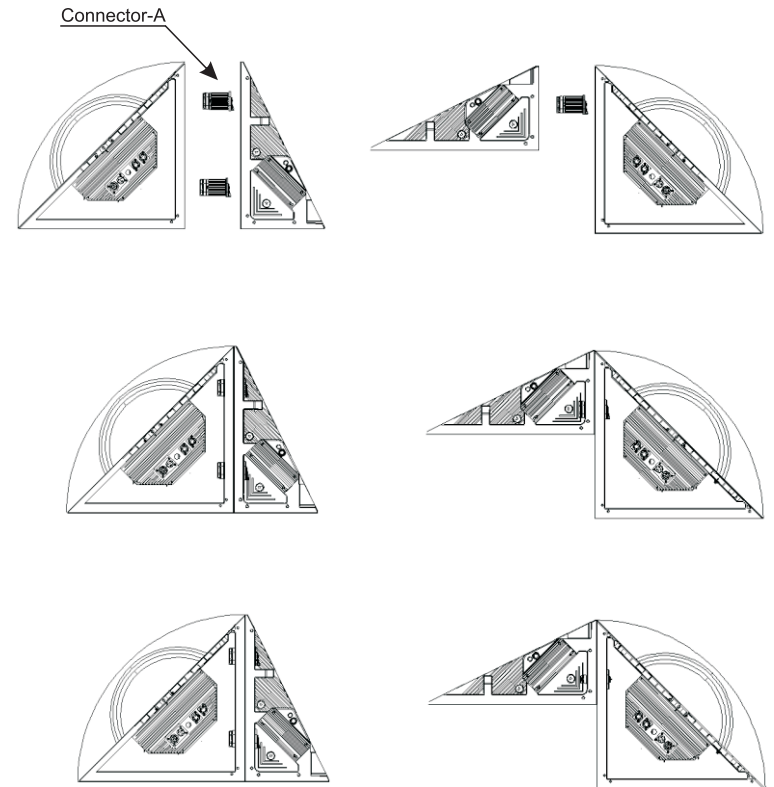

Figure 3.1.5 MG14 connected with MG13 cabinet

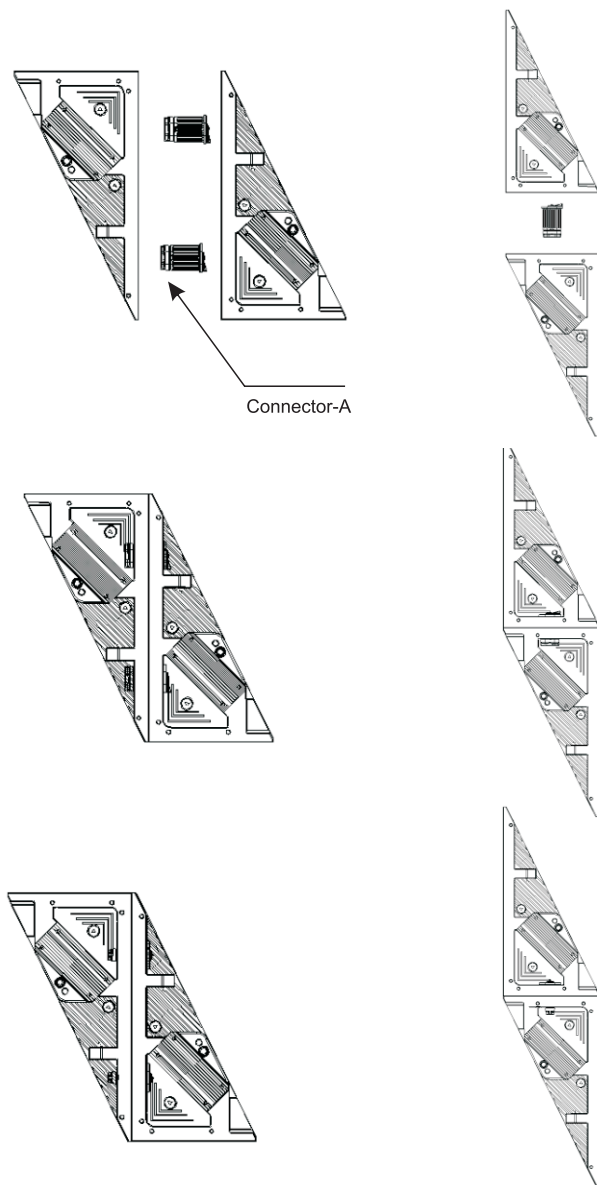

Figure 3.1.6 MG14 connected with MG14 cabinet

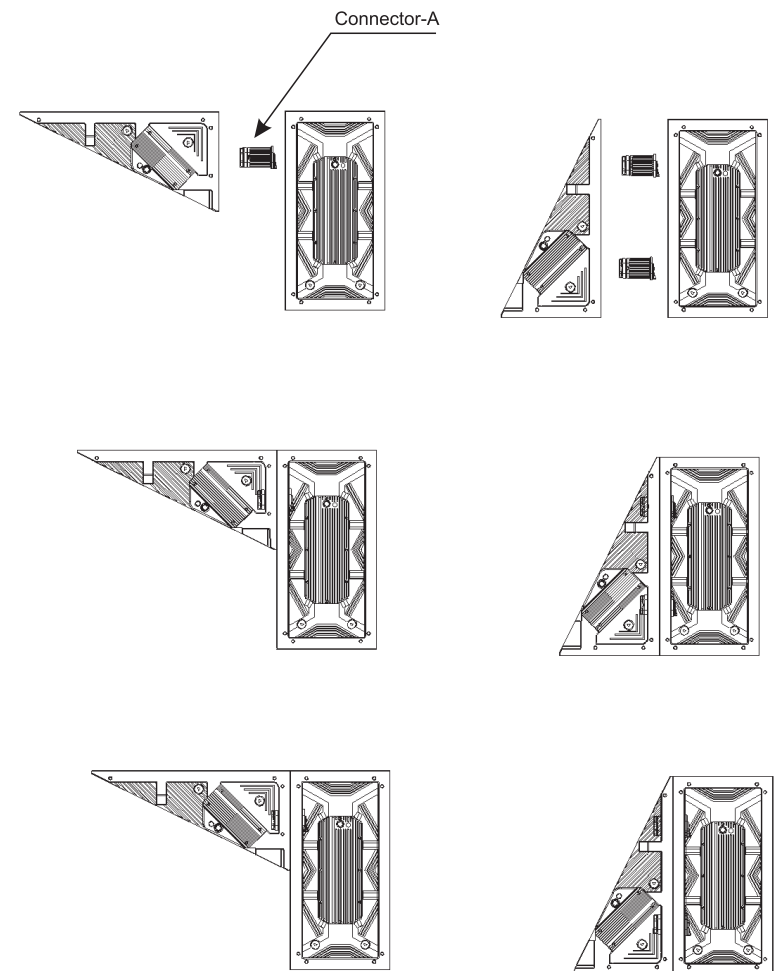

Figure 3.1.7 MG14 connected with MG15 cabinet

Using with MG7 (or MG6), MG12 and MG15 cabinet, MG14 cabinet can splice into a circular screen, as Figure 3.1.8. The min diameter is 2m, as Figure 3.1.9.

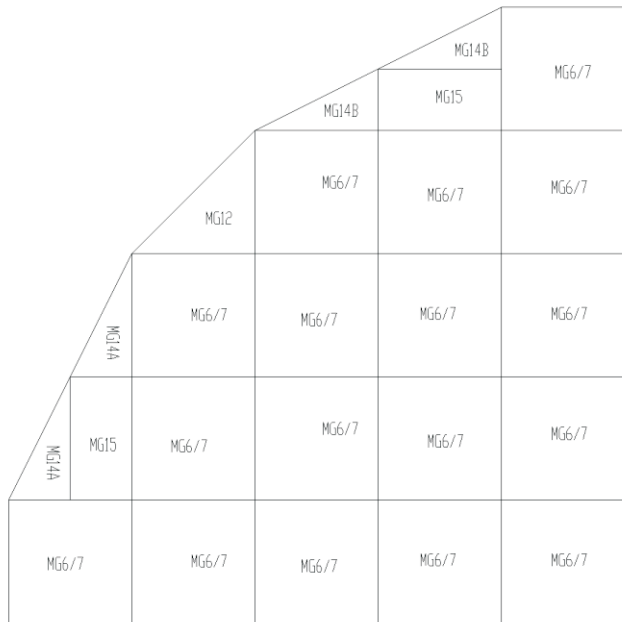

Figure 3.1.8 MG14 install a circle with diameter  $\geq 2m$

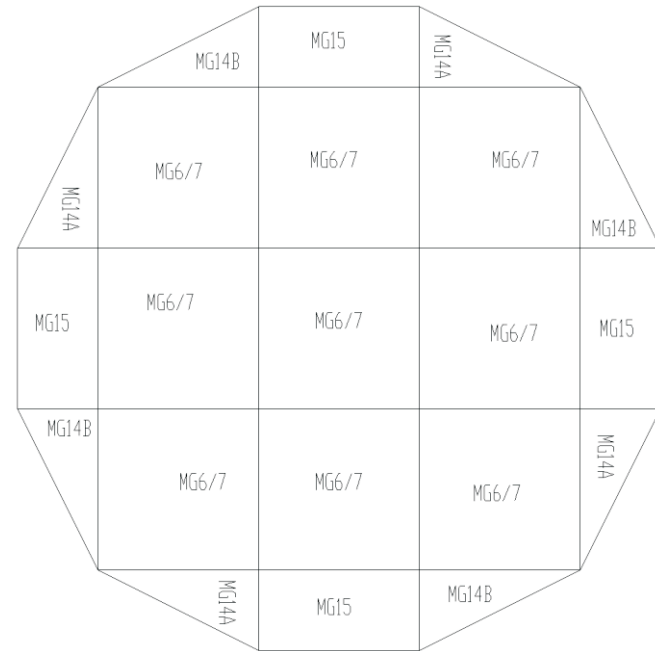

Figure 3.1.9 MG14 installs a minimum circle ( $d=2m$ )

Compared with the traditional LED cabinet, Magic MG14 cabinet designed with several dislocation holes, it provides more possibility for creative shapes. Different splice with different installation holes, details please check Figure 3.1.10.

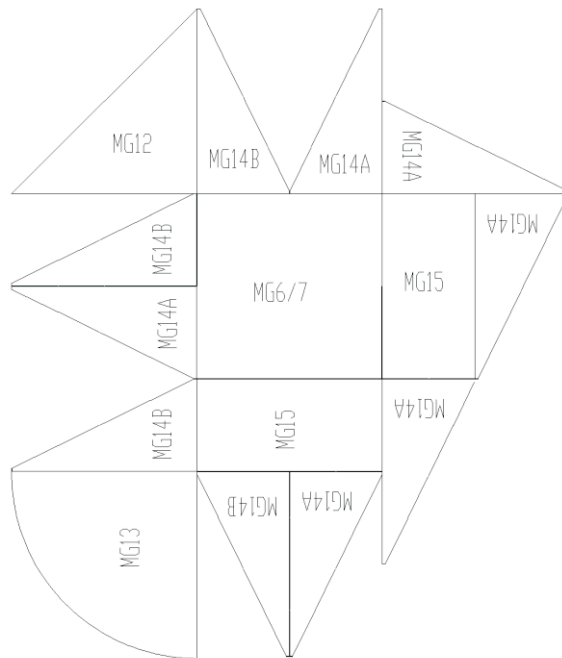

Figure 3.1.10 MG14 connected with other MG products

### 3.2 MG14 Series LED Screen Packing

There are two packing way for MG14 cabinet.

- 1) Flight case packing; each 10 MG14 cabinets will be packed in 1 flight case.
- 2) Wooden case packing; the cabinet will be packed by carton at first, then put in wooden case for transportation. (Figure 3.2.1- 3.2.2)

Note: When using flight case packing, before indoor cabinets are put into flight case or carton, PE bag + desiccant bag should be used for moisture-proof treatment. Outdoor cabinets can be put into flight case or carton directly. When using carton packing, whether outdoor or indoor cabinets, all need to use PE bag + desiccant package for moisture-proof treatment.

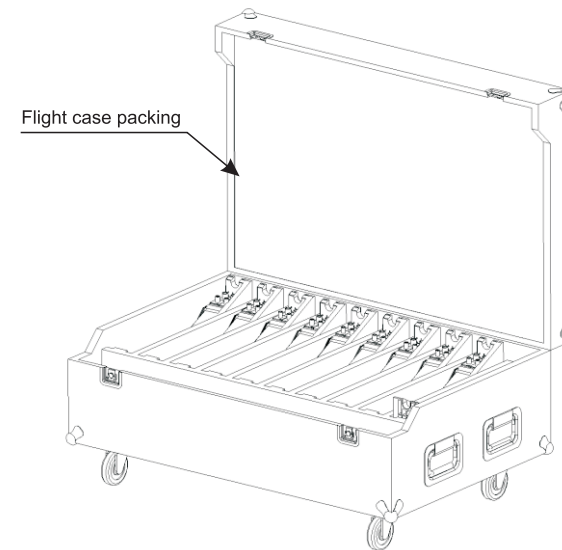

Figure 3.2.1 MG14- Flight Case Packing

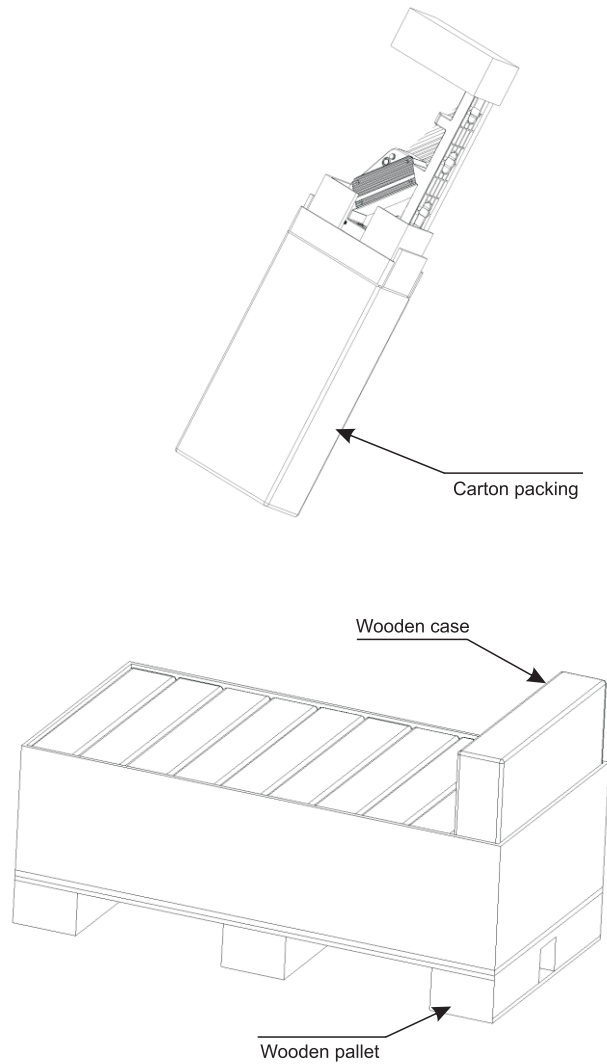

Figure 3.2.2 MG14- Carton Packing

## Chapter 4 Frequently Questions For LED Screen

### 4.1 Software Questions

1. Connection interruption or prompt unable to find the control card when starting the software, or the interface of the software is not adjustable, that is, gray status, and there is no main controlling icon of the software LED control equipment list.

Solution:

- ① Change USB cable.
- ② Check the equipment connection in the equipment manager.
- ③ Ensure that the computer is virus-free.
- ④ If it is the internal sending card, it is probably due to the loose slot or damaged PCI, or the interference of foreign matter. Please insert sending card again or clean PCI interface by rubber.

2. Indicator light of the output port for sending card is extinguished.

Solution:

- ① Relevant control software has not been installed, please ensure the software is successfully installed.
- ② The FPD of the graphics card is closed. Please right-click "my computer" on the desktop, and then click properties-> setting-> advanced> display-> FPD.

## Chapter 5

### LED Screen Maintenance

#### 4.2 Hardware Questions

1. There is no content on the LED screen.

Solution:

- a. Check whether the screen is powered on.
- b. Check whether the output signal is open.
- c. Check whether display area is correct.

2. The cabinet of the LED screen is blurred or not bright enough in certain cabinets.

Solution:

- a. Check whether modules and HUB card is connected.
- b. Check whether the configuration file is uploaded correctly.
- c. Check whether the calibration is open or correct.
- d. Please change the broken masks if there is.

3. The picture of the cabinet is in a wrong order.

Solution: Please check the inner connection of each LED module to see if cables are well connected.

4. Some individual LED lamps are extinguished.

Solution: Please repair these dead LEDs.

Proper use of the LED screen is very important for the long lifespan of the LED screen and the proper function. Daily maintenance of the LED screen must be finished carefully.

1. Please read the MG7 series LED Screen User Manual carefully. The manufacturer does not take any legal liability of the consequence due to the incorrect, incomplete, irresponsible, or unsafe use of the installation system.

2. Handle the LED screen cabinet with care, avoid collision and strike.

3. Check the cabinet carefully to make sure there is no loose screw before using.

4. Please confirm the steel frames are kept in place firmly before installation, for the screen already been installed for a long time, regular checking the situation of the connection part is required. If found any loose part, adjust it timely, reinforce or change new hanging parts in time.

5. Keep the whole cabinet frame structure away from oil, acid and other corrosive material.

Pay attention to the anti-static work of the screen body, do not touch the LED face directly by hand. It is recommended to wear gloves for the installation and debugging of the display screen.

7. Null line and firing line of the power cable in a computer or the control system can't be connected reversely, It should be connected strictly according to the original position.

8. If the power switch trip happened frequently, please check the screen or replace the power supply switch.

9. Before lighting the screen, turn on the PC first, and then turn on the LED screen. When stopping work of the screen, first turn off the LED screen, then turn off the PC (otherwise, it will cause the screen highlights, burn the lamp, the consequences are serious).

10. If there is short circuit, switch trip, wire burning, smoke and other abnormal phenomenon after removing, please don't repeat electricity test, and check the problem timely.

11. The proper way to remove a power supply: Place the back of cabinet face up, and keep the air connector face down; loosen the screws on aluminum cooling board and lift the aluminum cooling board up horizontally to 30 ~ 40mm (meanwhile observing the power supply box interior), overturn the aluminum cooling board to right slowly (Attention to prevent radiator's fan crashing other component), then start checking and repairing.

12. Master the installation method, the original data recovery, backup, and controlling parameter setting, basic data preset modification.

13. Inspect virus regularly, and remove irrelevant data.

14. Software operation is under professional engineers.

15. Please do not perform in the storm (rain, dust) and strong wind;

16. Dismantle the LED screen after the events, please clean the water stains and dust on the two sides of each cabinet before putting them into the flight case, the internal space of flight case must be clean and dry, if there is moist , you must dry them in the sun, or dry it with the dryer. At the same time, too much friction should be avoided between cabinet and inner part of the flight case.

17. When installing and removing the LED screen, special attention must be paid to the protection of the LEDs on the four sides of the LED cabinet to prevent LEDs from damage.

18. Outdoor display not only need to consider the wet problem, but also to do waterproof, dust proof and other routine maintenance work; good sealed installation can help the LED screen to reduce the risk of water go inside. Regular cleaning attached to the dust of inside and outside the screen also help LED screen better heat dissipation, reduce the water vapor attached;

19. Wet and rainy weather can cause the dew on the wall, please keep the cabinet away from the wet wall, to avoid the water on the wall.

20. For the warehouse where products are placed, it is necessary to keep it dry and ventilated, so that damp air cannot be concentrated in the warehouse. It is suggested to locate the site at a higher place.



## Chapter 6

### Product Parameter & Specification

Items		YMG14-M04NFD
Module	LED encapsulation	2020 black
	pixel pitch (mm)	4.8
	module resolution (W×H)	/
	module size (mm)	/
Cabinet	module per cabinet (W×H)	1×1
	resolution (W×H)	/
	size (mm)	250×500×73
	area (m <sup>2</sup> )	0.0625
	weight (kg/cabinet)	2.1
	pixel density (dot/m <sup>2</sup> )	43264
	IP grade	IP50
	flatness (mm)	≤0.5
Optical Parameters	brightness correction	ok
	color correction	ok
	brightness before correcting (nit)	-
	white balance brightness (nit)	800~1200
	color temperature (K)	7000±300K
	horizontal viewing angle ( ° )	160
	vertical viewing angle ( ° )	120
	pixel center distance	<3%
	brightness uniformity	≥97%
	color uniformity	within ±0.003Cx,Cy
contrast ratio	3000:1	
Electrical Parameters	power consumption (W/cabinet)	Max: 35 Average: 12
	working voltage	AC100~240V(50/60Hz)
Processing Performance	driving method	constant drive
	scan	1/13
	frame frequency (Hz)	50&60
	refresh rate (Hz)	≥1920
	control system	Nova
Usage parameters	life span (h)	80,000
	environmental temperature (°C)	working temperature: -20~50
		storage temperature: -40~60
	environmental humidity (RH)	working: 10 - 90%(no condensation)
		storage: 10 - 95% (no condensation)
communication mode	CAT5	
min circle diameter (m)	2	
Certificate	Product certification	-

Items		YMG14-M04UFQ
Module	LED encapsulation	1921
	pixel pitch (mm)	4.8
	module resolution (W×H)	/
	module size (mm)	/
	module per cabinet (W×H)	1×1
Cabinet	resolution (W×H)	/
	size (mm)	250×500×73
	area (m <sup>2</sup> )	0.0625
	weight (kg/cabinet)	4
	pixel density (dot/m <sup>2</sup> )	43264
	IP grade	Front IP65 Rear IP54
	flatness (mm)	≤0.5
	Optical Parameters	brightness correction
color correction		ok
brightness before correcting (nit)		-
white balance brightness (nit)		4000~4500 4500~5000
color temperature (K)		8000±300K
horizontal viewing angle ( ° )		160
vertical viewing angle ( ° )		120
pixel center distance		<3%
brightness uniformity		≥97%
color uniformity		within ±0.003Cx,Cy
contrast ratio	5000:1	
Electrical Parameters	power consumption (W/cabinet)	Max: 40 Average: 14
	working voltage	AC100~240V(50/60Hz)
Processing Performance	driving method	constant drive
	scan	1/13
	frame frequency (Hz)	50&60
	refresh rate (Hz)	≥1920
	control system	Nova
Usage parameters	life span (h)	80,000
	environmental temperature (°C)	working temperature: -20~50
		storage temperature: -40~60
	environmental humidity (RH)	working: 10 - 90%(no condensation)
		storage: 10 - 95% (no condensation)
communication mode	CAT5	
min circle diameter (m)	2	
Certificate	Product certification	-